

---

# **Methodology for Flow and Salinity Estimates in the Sacramento-San Joaquin Delta and Suisun Marsh**

**23<sup>rd</sup> Annual Progress Report  
June 2002**

## **Chapter 4: CALSIM versus DSM2 ANN and G-model Comparisons**

**Author: Michael Mierzwa**

# 4 CALSIM versus DSM2 ANN and G-model Comparisons

## 4.1 Introduction

DWR’s Delta Modeling Section has developed an Artificial Neural Network (ANN) trained on a series of DSM2 simulations to estimate salinity within CALSIM II. Wilbur et al. (2001) provided a detailed description of how this ANN was integrated into CALSIM II. Prior to use of the ANN within CALSIM, the G-model was used to estimate the Delta’s flow-salinity relationships. Since the ANN is trained on various flow regimes and Delta Cross Channel position, it may represent both existing and new Delta configurations. However, the current ANN was not trained for high Banks Pumping Plant export conditions.

Four DSM2 planning studies were run based on different monthly CALSIM studies, where the maximum Banks pumping capacity was increased to 10,300 cfs. Two of these CALSIM studies used the ANN to estimate the Delta flow-salinity relationships, and the other two CALSIM studies used the G-model. DSM2-HYDRO was run using a design repeating tide, and then DSM2-QUAL was used to determine if salinity was being over- or underestimated in CALSIM. The results of these four 16-year studies are presented in this report for three water quality locations: Emmaton, Jersey Point, and Rock Slough.

## 4.2 Description of Scenarios

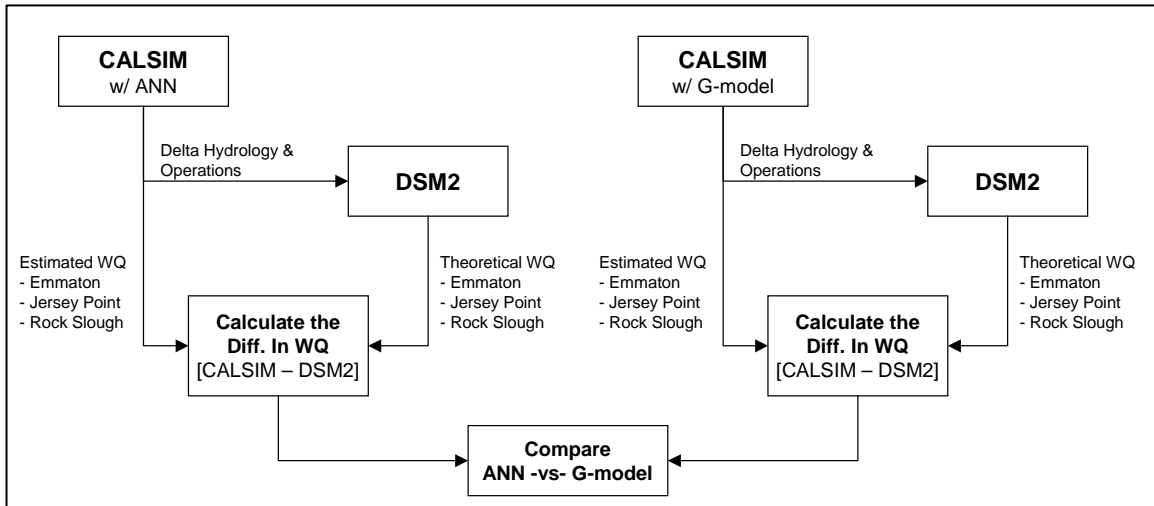
All four CALSIM II scenarios considered the maximum pumping capacity at Banks Pumping Plant (SWP) to be 10,300 cfs and to have a 2020 level of development for the system demands. Two of the CALSIM II scenarios were optimized to meet the D-1485 water quality standards, and the remaining two CALSIM II scenarios optimized the D-1641 water quality standards. One of the D-1485 CALSIM II scenarios used the DSM2 ANN to estimate salinity, while the other D-1485 CALSIM II scenario used the G-model. Similarly, one of the D-1641 CALSIM scenarios used the DSM2 ANN to estimate salinity, while the remaining scenario was based on G-model salinity estimates.

**Table 4.1: Summary of DSM2 Planning Studies.**

DSM2 Study	CALSIM II Study		CALSIM II Salinity Model	
	D-1485	D-1641	ANN	G-model
1	•		•	
2	•			•
3		•	•	
4		•		•

These four DSM2 studies were then used to calculate the difference in salinity (converted to EC in CALSIM and modeled directly as EC in DSM2) between CALSIM and DSM2 using a

methodology illustrated in Figure 4.1. First, two CALSIM simulations were run using D-1485 operations. One of these CALSIM simulations used the ANN to estimate EC standards in the Delta, while the other CALSIM simulation used the G-model. The resulting Delta hydrology and operations from each CALSIM simulation was then used to run DSM2. Next, the theoretical water quality results from DSM2 were subtracted from the estimated water quality results that were calculated by each model within CALSIM. These differences were then used to compute several statistical measures in order to compare the ANN versus the G-model.



**Figure 4.1: Study Methodology.**

### 4.3 Simulation Inputs

The basic simulation inputs / constraints for the two different models used, CALSIM and DSM2, are described below.

#### 4.3.1 CALSIM

Two different Bay-Delta standards, State Water Resources Control Board (SWRCB) D-1485 and D-1641, were used to establish the priorities of water allocation within CALSIM. Although these are daily salinity standards for both D-1485 and D-1641, CALSIM makes its decisions based on an equivalent monthly averaged EC. CALSIM used either the G-model or an ANN trained specifically for use within CALSIM D-1485 studies to estimate EC at Emmaton, Jersey Point, and Rock Slough.<sup>1</sup> The estimated EC from these models was then used as an operating constraint within CALSIM for both the D-1485 and D-1641 studies, such that CALSIM would optimize its water allocation decisions without violating Delta salinity standards.

<sup>1</sup> The CALSIM D-1485 G-model and ANN routines also estimate EC at Collinsville, Antioch, and Mallard Island. However, water quality violations rarely occur at these three locations and, due to the close proximity of these three locations to the ocean, the differences between the G-model and ANN at these locations is small.

The methods used to estimate EC and chloride by the G-model and ANN in CALSIM are summarized below.

### **G-model**

EC (umhos/cm) for Emmaton and Jersey Point were calculated directly as functions of the G-model (Denton and Sullivan, 1993). Chloride (mg/l) at Contra Costa's Pumping Plant #1 in Rock Slough was then calculated as a function of the current (t) and previous (t-1) month's Jersey Point EC as is described in Equation 4-1:

$$Cl_{CCPP\#1_t} = 0.061EC_{JP_t} + 0.050EC_{JP_{t-1}} \quad [\text{Eqn. 4-1}]$$

### **ANN**

EC (umhos/cm) for Emmaton and Jersey Point were calculated directly using the ANN. EC at the entrance to Rock Slough on the Old River was then calculated as a function of the current (t) and previous (t-1) month's Jersey Point EC, as is described in Equation 4-2:

$$EC_{RS_t} = 0.188EC_{JP_t} + 0.1401EC_{JP_{t-1}} + 142.25 \quad [\text{Eqn. 4-2}]$$

EC at the entrance to Rock Slough was then converted to chloride for Contra Costa's Pumping Plant #1, based on Equation 4-3 (see Wilbur et al., 2001):

$$Cl_{CCPP\#1_t} = 0.268EC_{RS_t} - 23.6 \quad [\text{Eqn. 4-3}]$$

When Equation 4-2 is combined with Equation 4-3, the relationship between chloride at Contra Costa's Pumping Plant #1 and EC calculated from the ANN at Jersey Point is described as:

$$Cl_{CCPP\#1_t} = 0.050EC_{JP_t} + 0.038EC_{JP_{t-1}} + 14.5 \quad [\text{Eqn. 4-4}]$$

### **4.3.2 DSM2**

A design repeating tide was used as the downstream boundary condition at Martinez.<sup>2</sup> The monthly hydrology (including the rim flows, exports, and diversions) was provided by CALSIM II. The CALSIM II studies assumed a 2020 level of development, thus 2020 DICU data used in previous DSM2 studies were used. The consumptive use in the Delta did not change for any of the four DSM2 studies. No South Delta Barriers were modeled. The Delta Cross Channel position was taken from the CALSIM II simulations.

Salinity was modeled as EC in DSM2. Martinez EC was generated using an ANN trained on net delta outflow.<sup>3</sup> Tidal variations in the Martinez EC are constructed using Kristof coefficients. The EC time series for the San Joaquin boundary condition was taken from CALSIM II

<sup>2</sup> The DSM2 monthly repeating tide does not account for the Spring-Neap variation.

<sup>3</sup> The ANN used to estimate EC at the Martinez boundary is different than the ANN used within CALSIM.

estimates. EC for the Sacramento River, Yolo Bypass, and Eastside streams was fixed at 150, 150, and 125 umhos/cm respectively.

## 4.4 Results

This report focuses on the relationship between CALSIM’s ANN and G-model derived EC and the EC as simulated by DSM2-QUAL for three locations: Emmaton, Jersey Point, and Old River at Rock Slough. Both the ANN and G-model EC estimates used within CALSIM are used within CALSIM to make operations decisions. In turn, 16-years of CALSIM operations are used as the hydrologic boundary conditions for DSM2.

### 4.4.1 Emmaton

The time series of EC at Emmaton calculated by both DSM2 and CALSIM II is shown for all four studies in Figures 4.2, 4.4, 4.6, and 4.8. The total exports (combined flow through Banks Pumping and Tracy Pumping Plants) for each of the four DSM2 studies are different and are shown on a secondary axis of each of the time series plots. Time series of the difference of the CALSIM salinity estimates from the modeled DSM2 EC are shown in Figures 4.3, 4.5, 4.7, and 4.9.

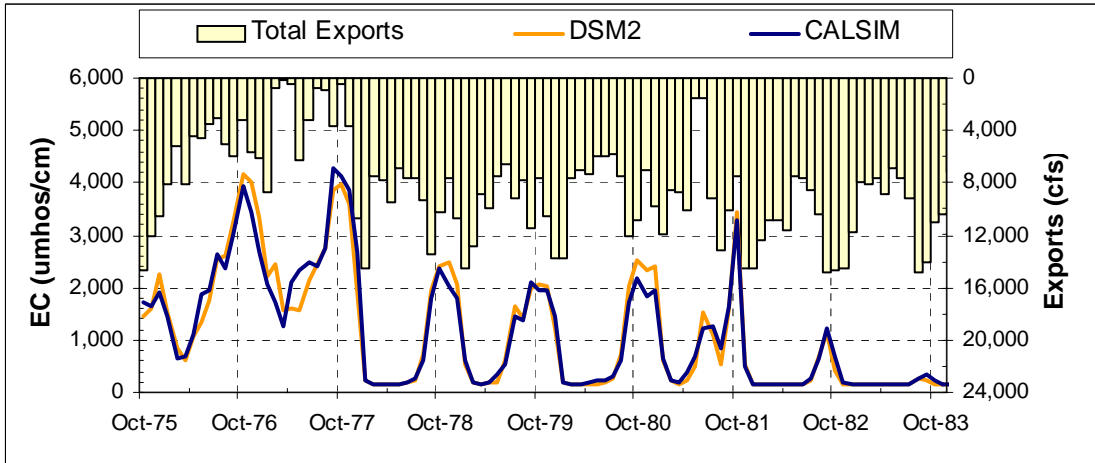
A summary of all of time series plots is listed below in Table 4.2. The maximum absolute difference in EC between CALSIM and DSM2 does not always correspond with the maximum EC values listed. DSM2 and CALSIM EC were higher in both G-model studies. The G-model over predicted the maximum EC in both studies (i.e., CALSIM EC is greater than DSM2 EC). Furthermore, the absolute difference in EC was lower when the ANN was used to estimate EC in CALSIM.

**Table 4.2: Emmaton EC (rounded to the nearest 50 umhos/cm).**

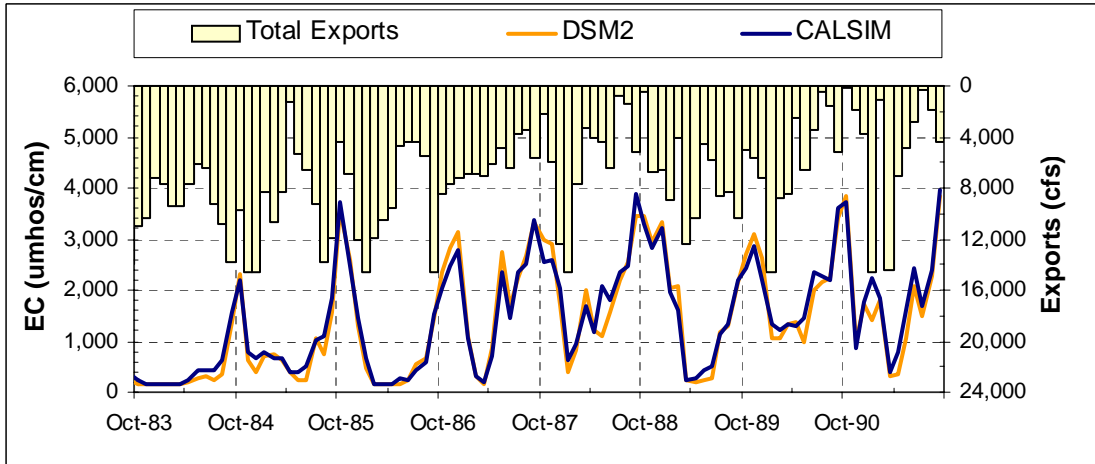
DSM2 Study	DSM2 Max EC (umhos/cm)	CALSIM Max EC (umhos/cm)	Max Absolute Diff. in EC* (umhos/cm)
1485 w/ ANN	4150	4300	1000
1485 w/ G-model	4500	5200	1450
1641 w/ ANN	4250	4150	950
1641 w/ G-model	4650	4900	1500

\*This is the maximum absolute value of the difference in EC, and does not correspond with the timing of the maximum EC.

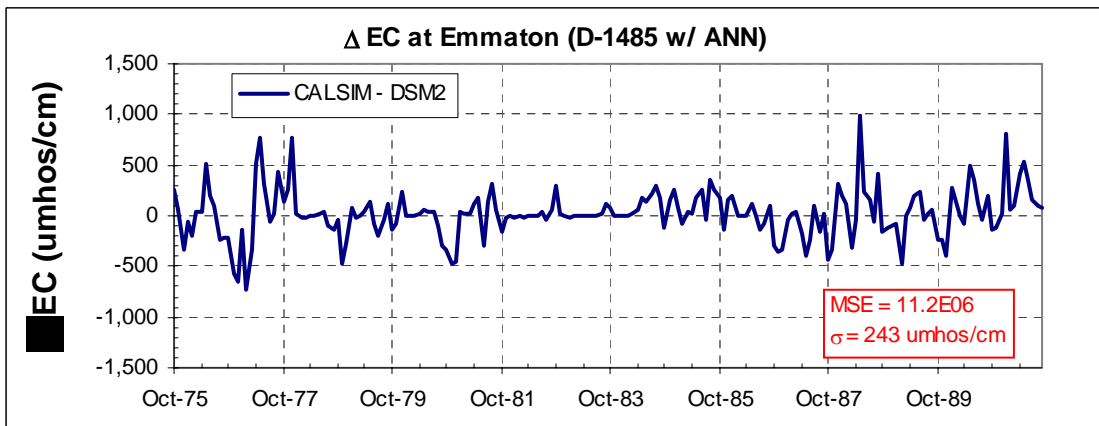
The Mean Squared Error (MSE) was calculated as the sum of the squares of the differences between CALSIM and DSM2 EC and is also shown on Figures 4.3, 4.5, 4.7, and 4.9. The estimated standard deviation,  $\sigma$ , for CALSIM EC was then calculated based on the MSE. The MSE (and  $\sigma$ ) for the ANN was lower than the MSE (and  $\sigma$ ) for the G-model.



**Figure 4.2a: DSM2 versus CALSIM EC at Emmaton for D-1485 using ANN: Water Years 1976-83.**



**Figure 4.2b: DSM2 versus CALSIM EC at Emmaton for D-1485 using ANN: Water Years 1984-91.**



**Figure 4.3: Difference in EC at Emmaton for D-1485 using ANN.**

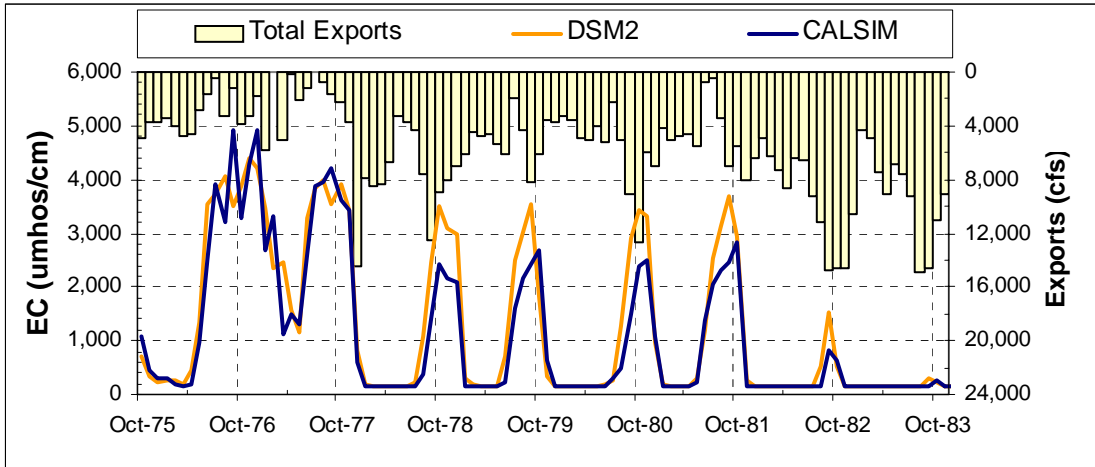


Figure 4.4a: DSM2 versus CALSIM EC at Emmaton for D-1485 using G-model: Water Years 1976-83.

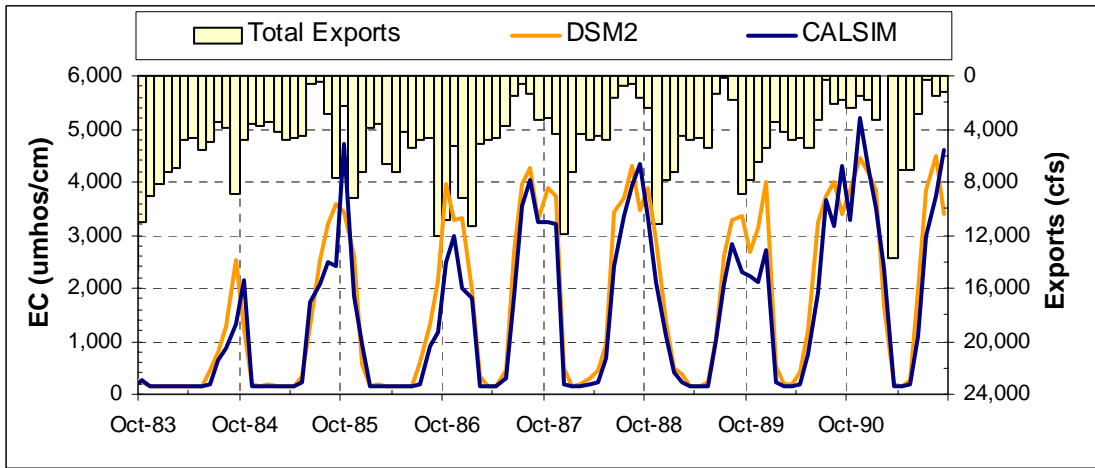


Figure 4.4b: DSM2 versus CALSIM EC at Emmaton for D-1485 using G-model: Water Years 1984-91.

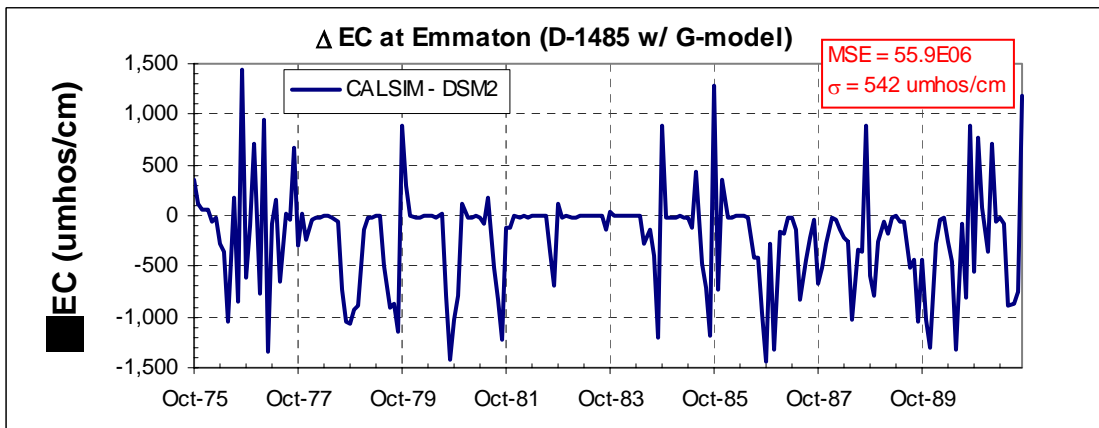
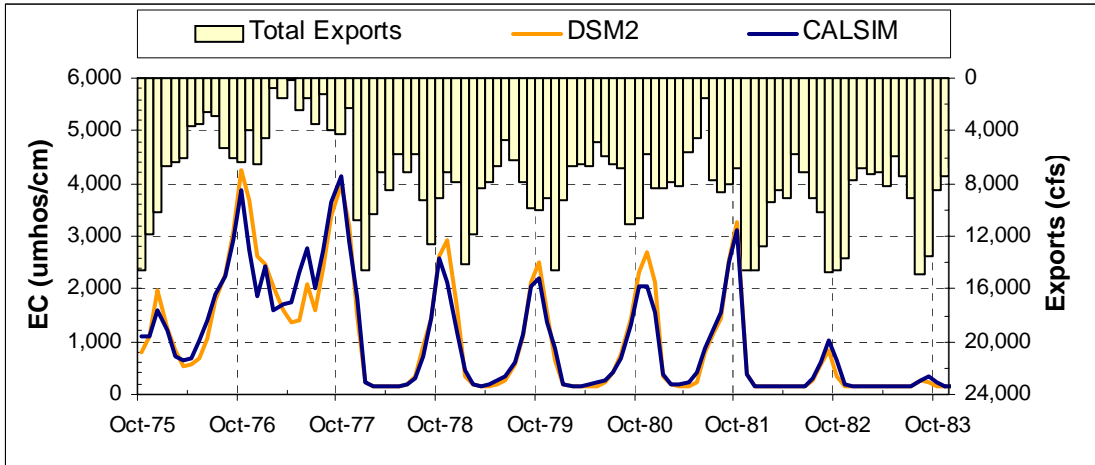
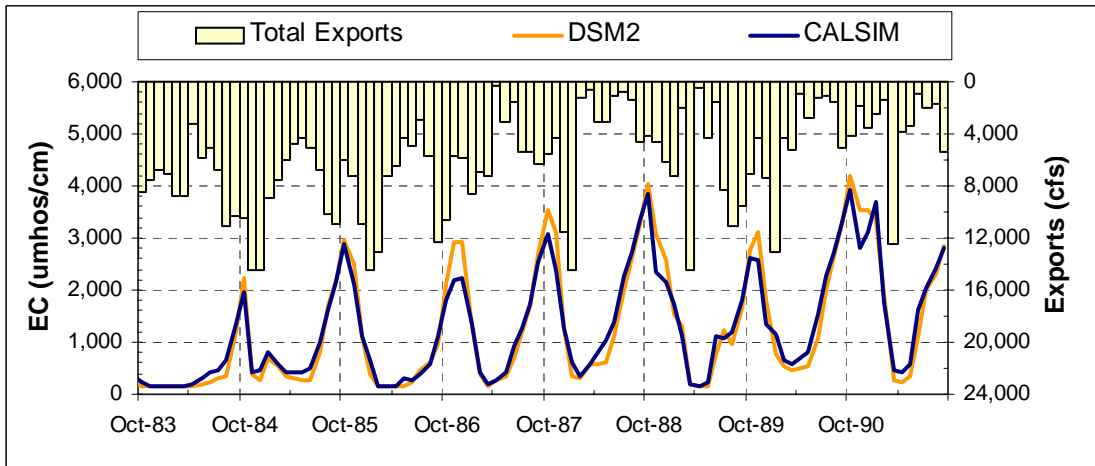


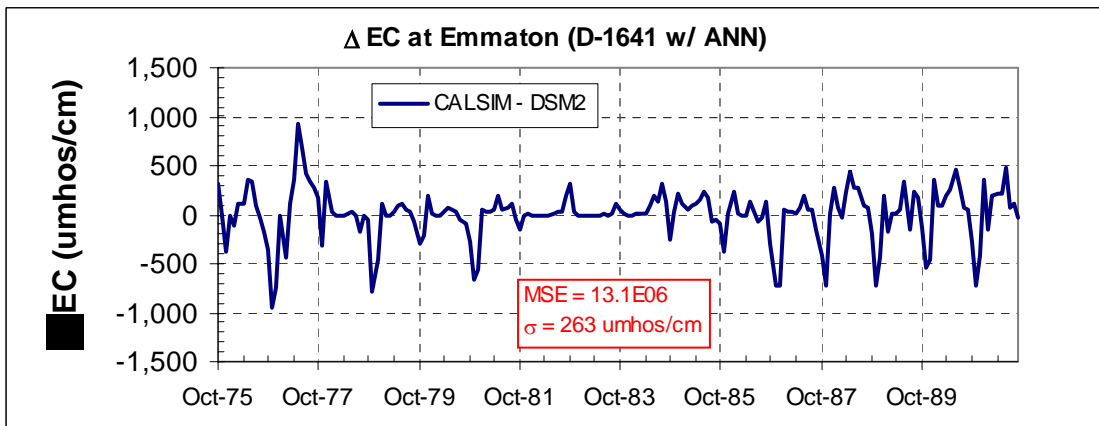
Figure 4.5: Difference in EC at Emmaton for D-1485 using G-model.



**Figure 4.6a: DSM2 versus CALSIM EC at Emmaton for D-1641 using ANN: Water Years 1976-83.**

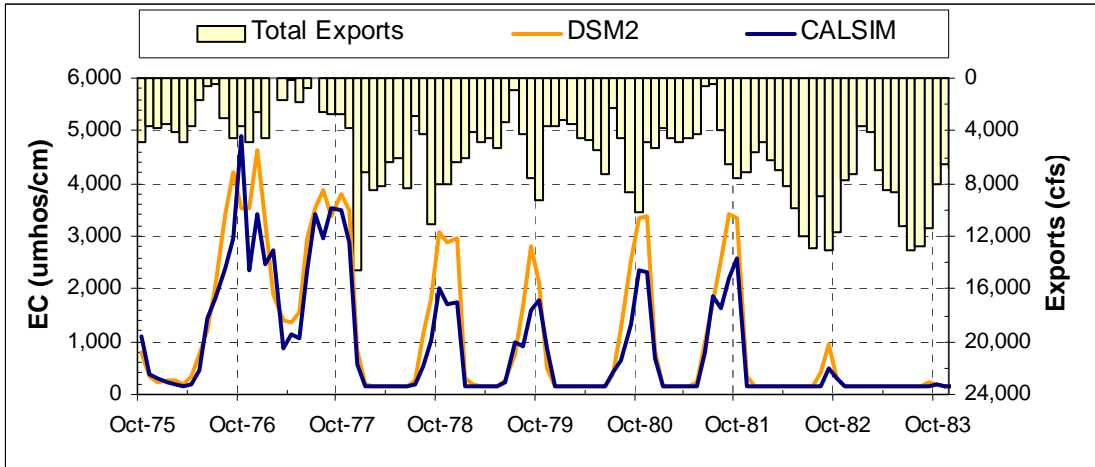


**Figure 4.6b: DSM2 versus CALSIM EC at Emmaton for D-1641 using ANN: Water Years 1984-91.**

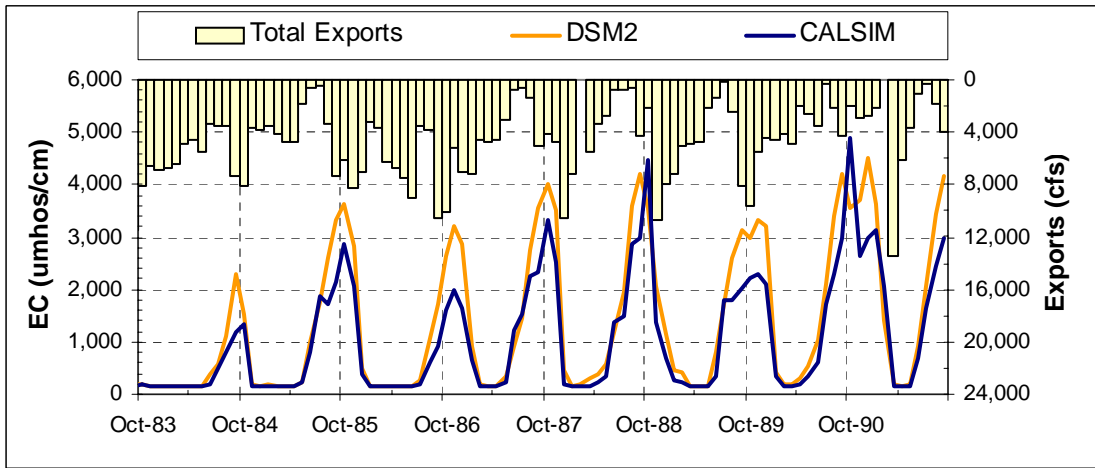


**Figure 4.7: Difference in EC at Emmaton for D-1641 using ANN.**

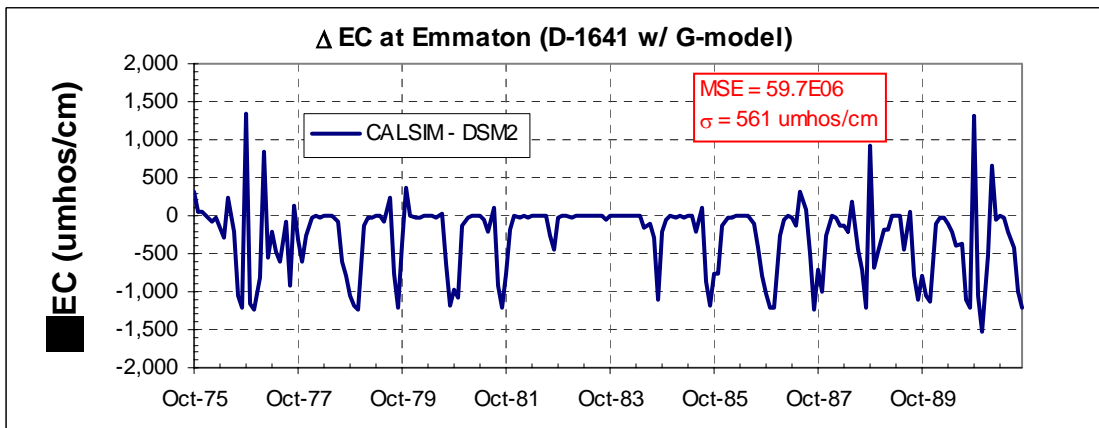




**Figure 4.8a: DSM2 versus CALSIM EC at Emmaton for D-1641 using G-model: Water Years 1976-83.**



**Figure 4.8b: DSM2 versus CALSIM EC at Emmaton for D-1641 using G-model: Water Years 1984-91.**



**Figure 4.9: Difference in EC at Emmaton for D-1641 using G-model.**

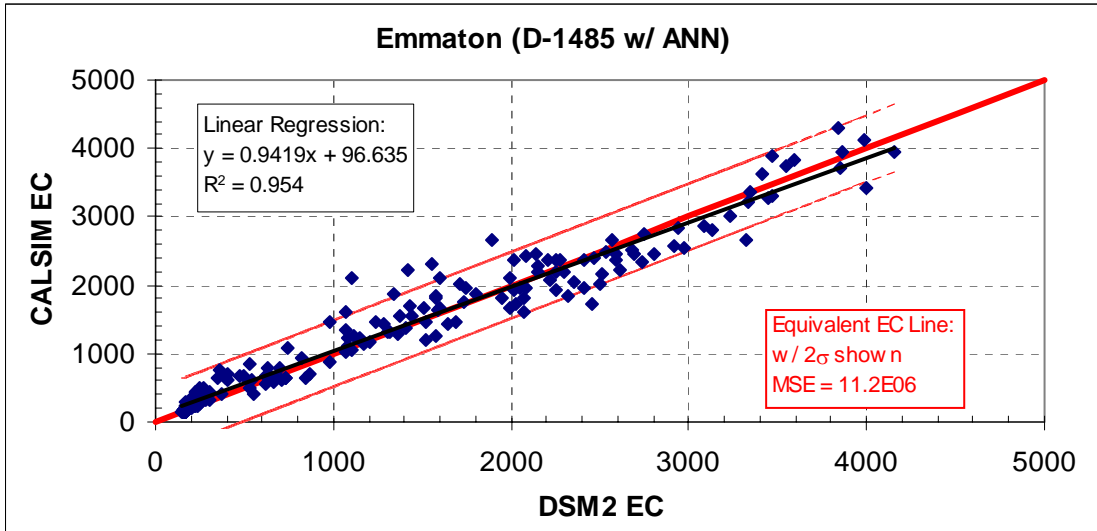
Scatter plots illustrating the relationship between DSM2 EC and CALSIM EC at Emmaton for each of the four studies are shown in Figures 4.10 – 4.13. An equivalent EC line (the 1:1 sloped line) is shown on each figure. This line represents the point where the estimated CALSIM EC matches the simulated DSM2 EC. The CALSIM EC is illustrated as a function of the DSM2 EC. The data will fall above the equivalent EC line when CALSIM is over predicting DSM2 EC. Similarly, the data will fall below the equivalent EC line when CALSIM is under predicting DSM2 EC. Estimates representing two standard deviations above and below this equivalent EC line are also shown and can be used as a measure of scatter of the data about the equivalent EC line. Best-fit lines based on simple linear regressions of the EC data, along with the regression statistics, are also shown on each plot.

A summary of the regression statistics for all of the Emmaton scatter plots is shown in Table 4.3. The MSE and estimated standard deviation,  $\sigma$ , were calculated from the difference between CALSIM and DSM2 EC. The MSE represents a measure of the scatter of the CALSIM EC data about the predicted EC. The slope of the best-fit line represents the bias of the linear regression from the equivalent EC line. When the slope of the best-fit line is less than 1.0, the general trend in the CALSIM data is to underestimate EC. As the slope decreases, this underestimation is more pronounced. The  $R^2$  value for the best-fit line (which should not be confused with the MSE based on the actual difference between CALSIM and DSM2) represents a measure of the scatter of the data about the best-fit line. As  $R^2$  approaches 1.0, the data will have a tighter fit about the best-fit line.

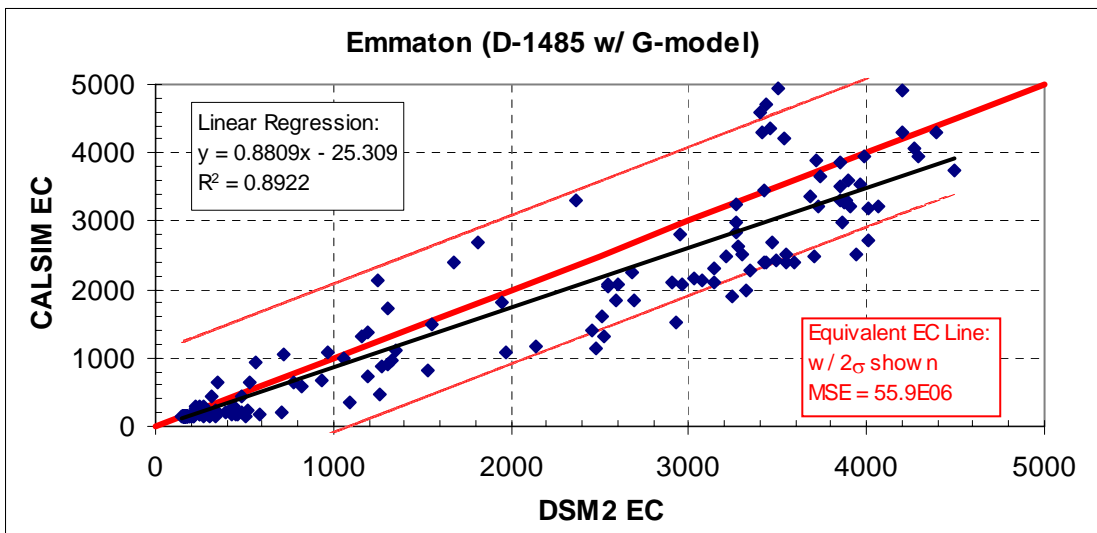
**Table 4.3: Summary of Emmaton Scatter Plots.**

DSM2 Study	MSE	$\sigma$ ( $\mu\text{mhos/cm}$ )	Slope of best-fit line	$R^2$ of best-fit line
1485 w/ ANN	11.2E06	243	0.94	0.95
1485 w/ G-model	55.9E06	542	0.88	0.89
1641 w/ ANN	13.1E06	263	0.89	0.95
1641 w/ G-model	59.7E06	561	0.76	0.89

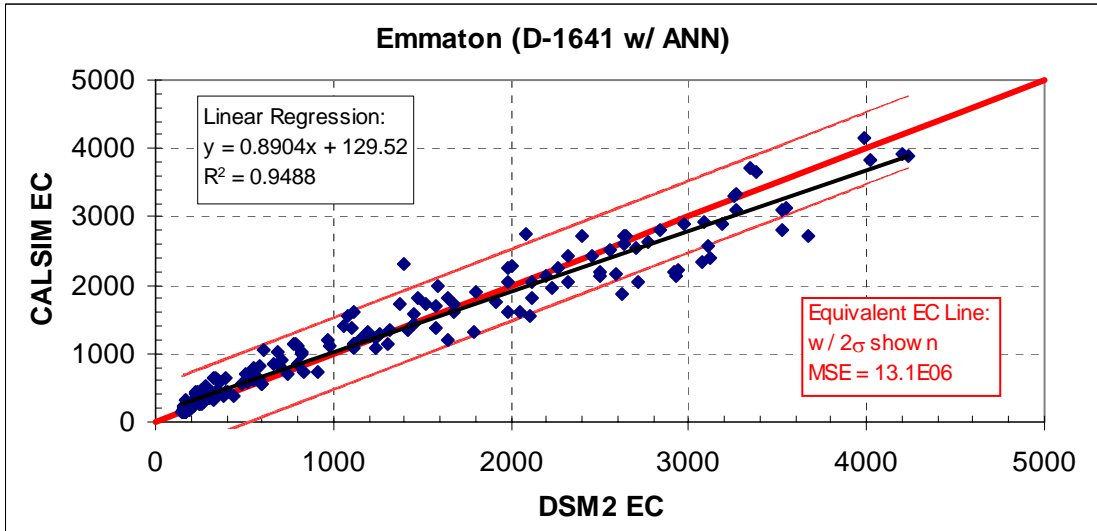
For both water quality base studies (D-1485 and D-1641) at Emmaton the ANN best-fit lines more closely matched the equivalent EC lines. The G-model results systematically underestimate the EC as calculated by DSM2. The MSE (and  $\sigma$ ) for the ANN was lower than the MSE (and  $\sigma$ ) for the G-model.



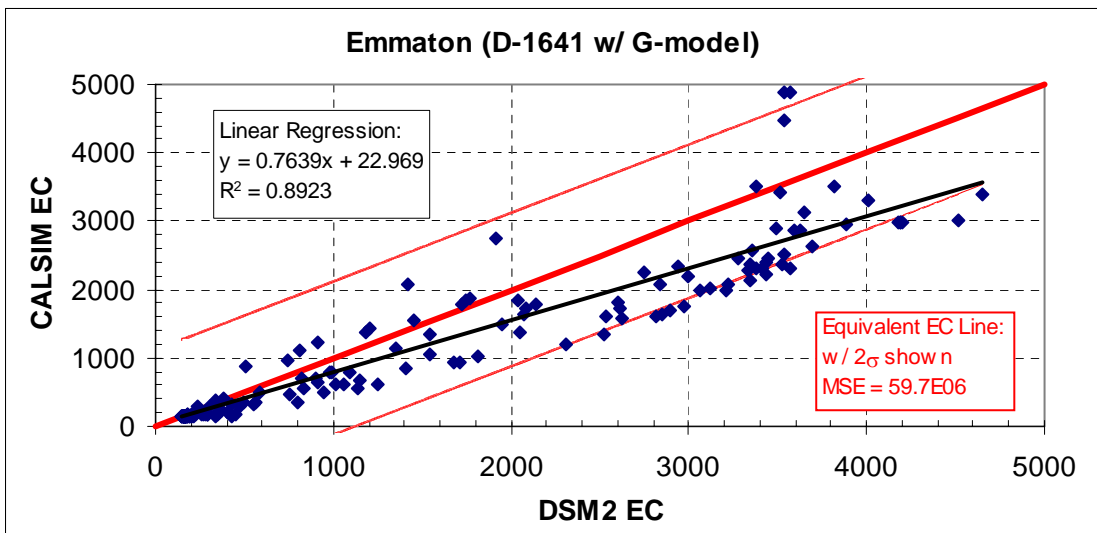
**Figure 4.10: Scatter Plot of CALSIM with ANN EC versus DSM2 EC for D-1485 at Emmaton.**



**Figure 4.11: Scatter Plot of CALSIM with G-model EC versus DSM2 EC for D-1485 at Emmaton.**



**Figure 4.12: Scatter Plot of CALSIM with ANN EC versus DSM2 EC for D-1641 at Emmaton.**



**Figure 4.13: Scatter Plot of CALSIM with G-model EC versus DSM2 EC for D-1641 at Emmaton.**

#### 4.4.2 Jersey Point

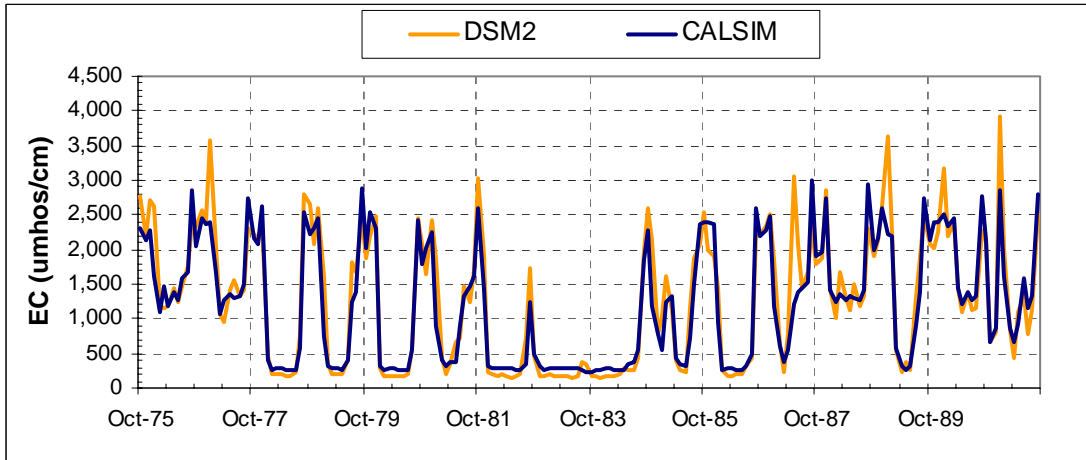
The time series of EC at Jersey Point calculated by both DSM2 and CALSIM II is shown for all four studies in Figures 4.14, 4.16, 4.18, and 4.20. The combined exports are shown on Figures 4.2, 4.4, 4.6, and 4.8 (Section 4.4.1). Time series of the difference of the CALSIM salinity estimates from the modeled DSM2 EC are shown in Figures 4.15, 4.17, 4.19, and 4.21. A summary of all of time series plots is listed below in Table 4.4.

**Table 4.4: Jersey Point EC (rounded to the nearest 50 umhos/cm).**

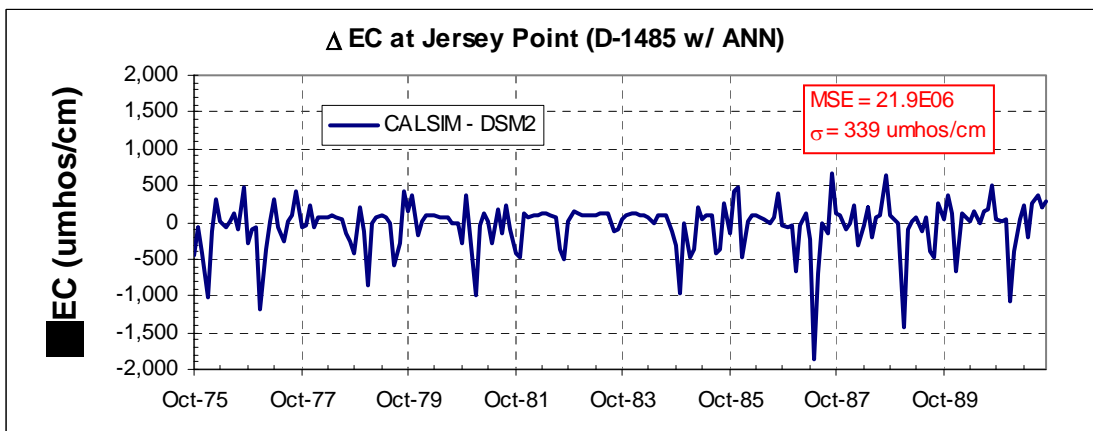
DSM2 Study	DSM2 Max EC (umhos/cm)	CALSIM Max EC (umhos/cm)	Max Absolute Diff. in EC* (umhos/cm)
1485 w/ ANN	4000	3000	1850
1485 w/ G-model	4550	2200	2800
1641 w/ ANN	3050	2950	900
1641 w/ G-model	3500	2200	1500

\*This is the maximum absolute value of the difference in EC, and does not correspond with the timing of the maximum EC.

As shown in Table 4.4 for Jersey Point, G-model under predicted the maximum EC in both studies (i.e., CALSIM EC is less than DSM2 EC), while the ANN under predicted the maximum EC in the D-1485 study. For both studies, the maximum absolute difference between CALSIM and DSM2 was lower when the ANN was used to estimate EC in CALSIM. However, this difference when the G-model was used in the D-1641 study was lower than the difference from the ANN comparison of the D-1485. In other words, CALSIM generally performed better in the D-1641 study.



**Figure 4.14: DSM2 versus CALSIM EC at Jersey Point for D-1485 using ANN.**



**Figure 4.15: Difference in EC at Jersey Point for D-1485 using ANN.**

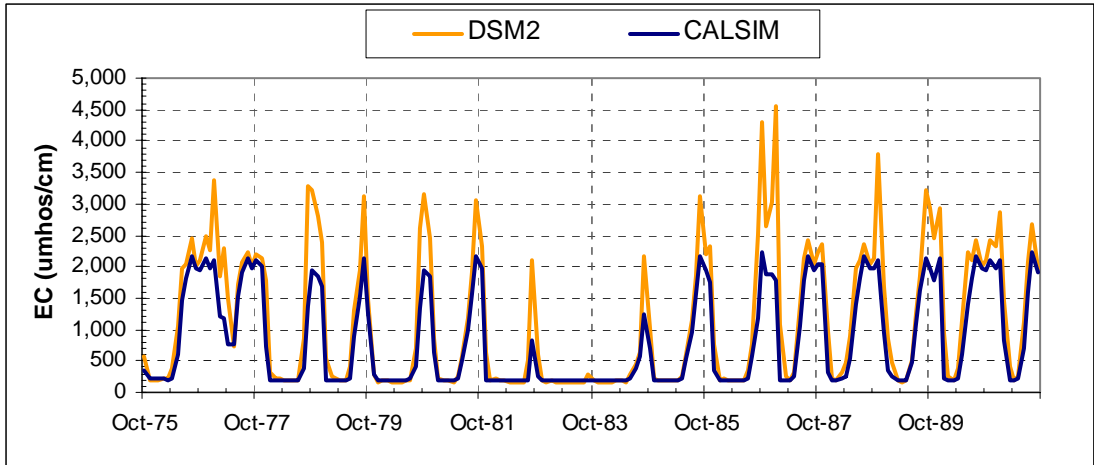


Figure 4.16: DSM2 versus CALSIM EC at Jersey Point for D-1485 using G-model.

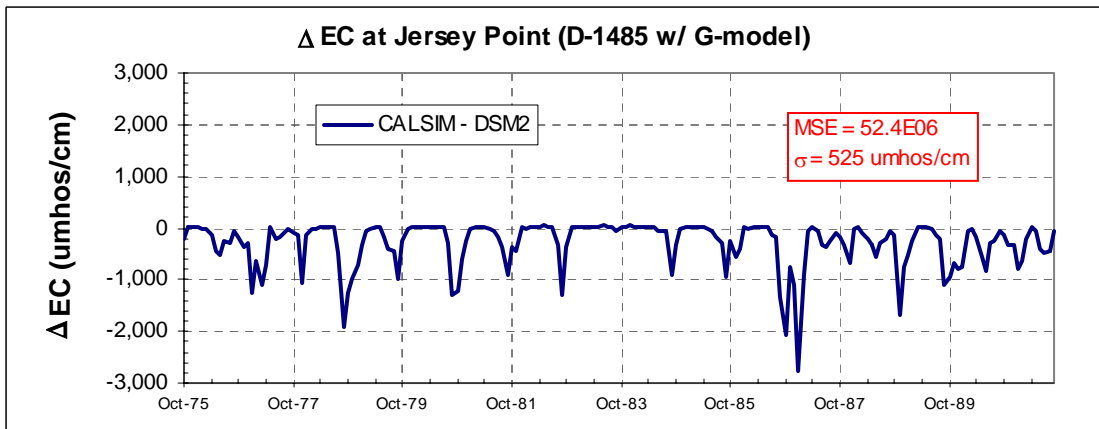


Figure 4.17: Difference in EC at Jersey Point for D-1485 using G-model.

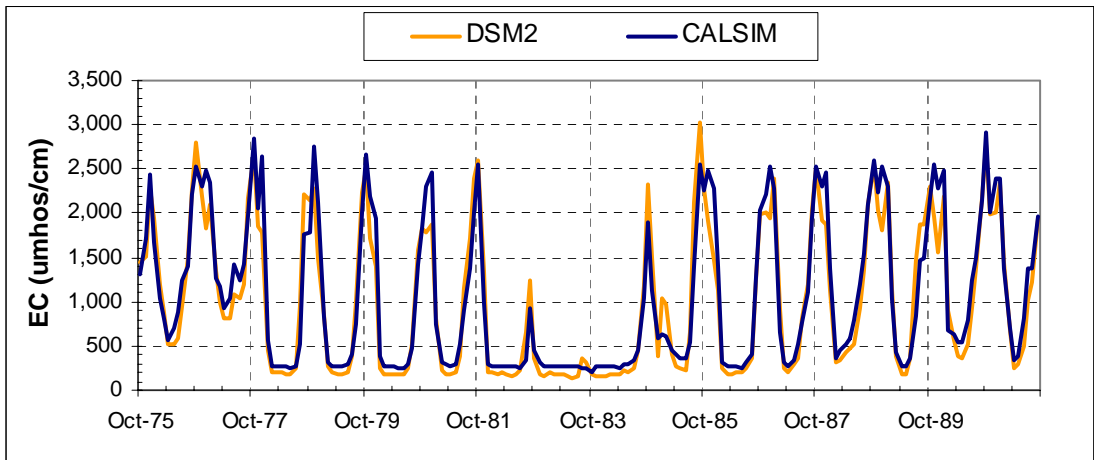
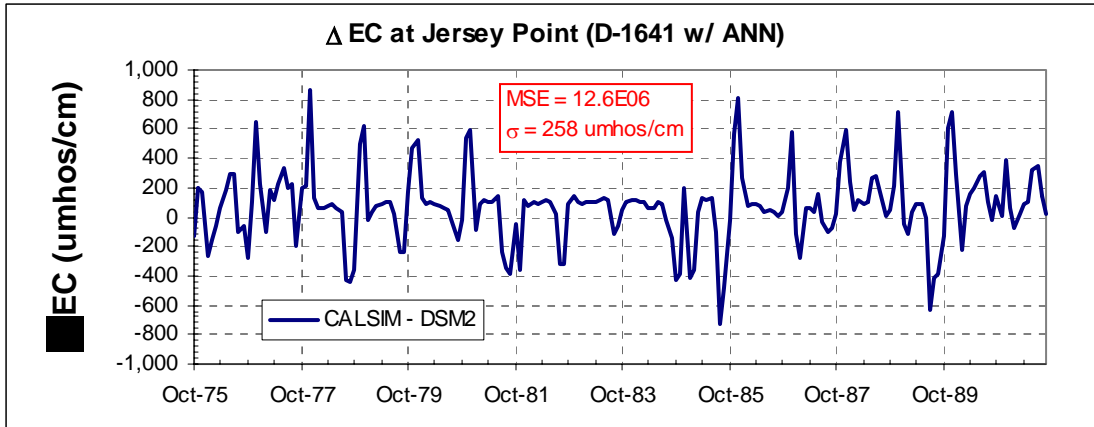
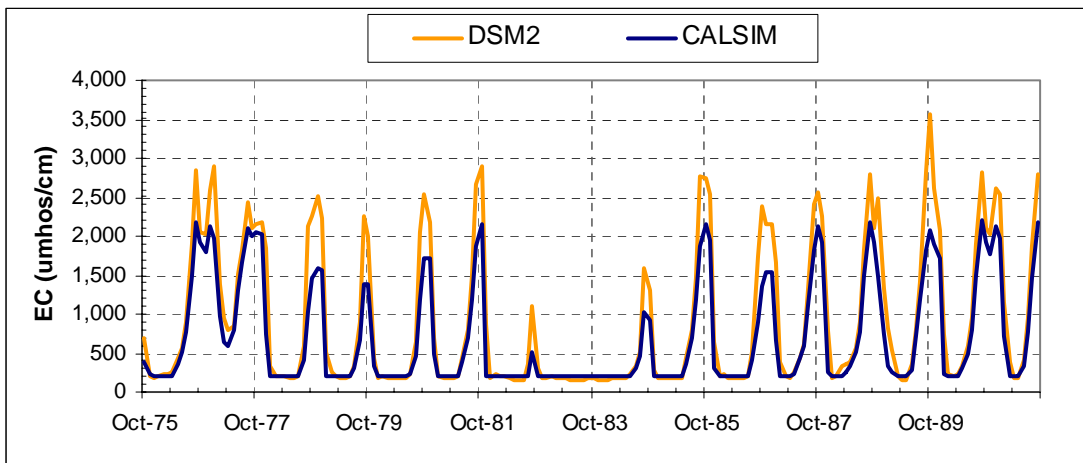


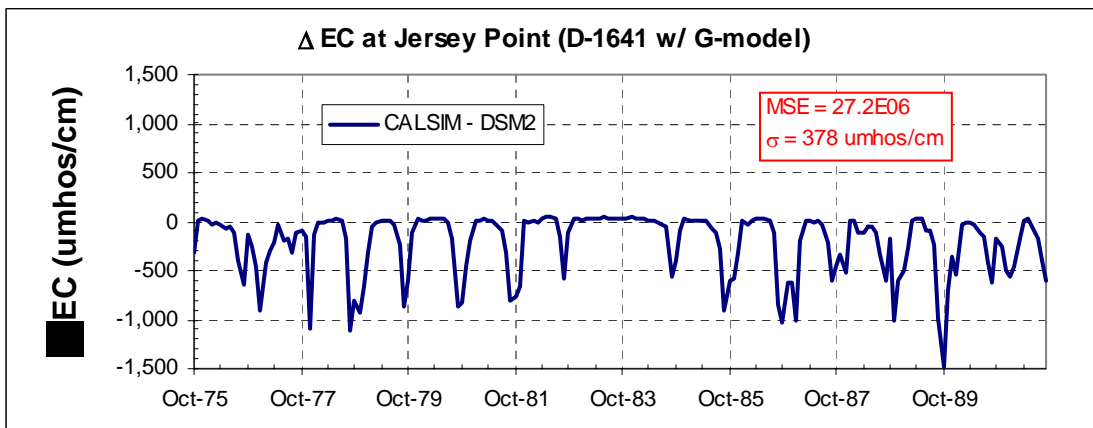
Figure 4.18: DSM2 versus CALSIM EC at Jersey Point for D-1641 using ANN.



**Figure 4.19: Difference in EC at Jersey Point for D-1641 using ANN.**



**Figure 4.20: DSM2 versus CALSIM EC at Jersey Point for D-1641 using G-model.**



**Figure 4.21: Difference in EC at Jersey Point for D-1641 using G-model.**

Scatter plots illustrating the relationship between DSM2 EC and CALSIM EC at Jersey Point for each of the four studies are shown in Figures 4.22 – 4.25. An equivalent EC line is shown on each figure. Data will fall above the equivalent EC line when CALSIM is over predicting DSM2

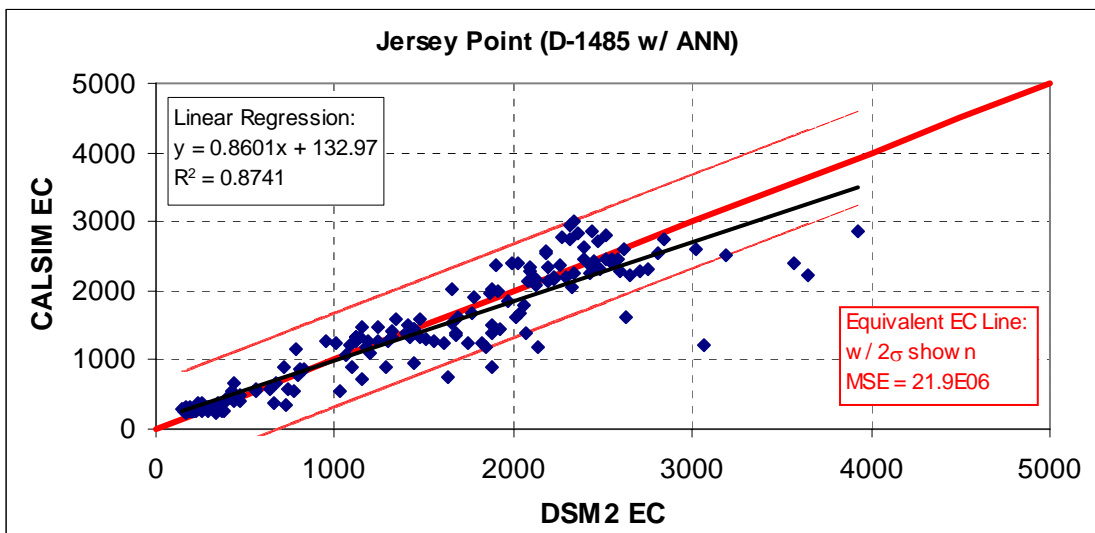
EC. Similarly, data will fall below the equivalent EC line when CALSIM is under predicting DSM2 EC. Estimates representing two standard deviations above and below this equivalent EC line are also shown and can be used as a measure of scatter of the data about the equivalent EC line. Best-fit lines based on simple linear regressions of the EC data, along with the regression statistics, are also shown on each plot.

A summary of the regression statistics for all of the Jersey Point scatter plots is shown in Table 4.5. A complete discussion of how these regression statistics were calculated and what they represent is described in Section 4.4.1.

**Table 4.5: Summary of Jersey Point Scatter Plots.**

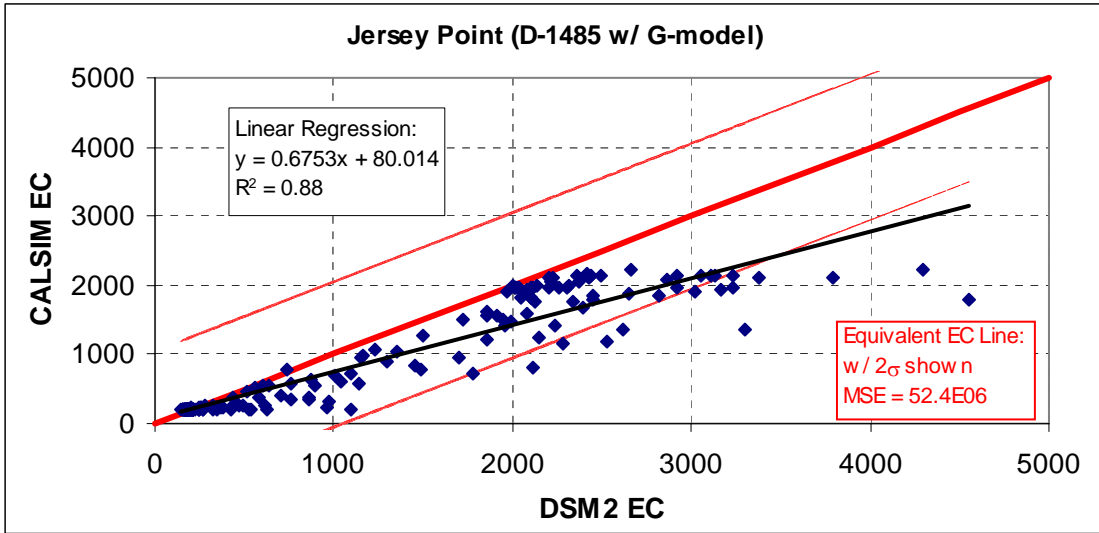
DSM2 Study	MSE	$\sigma$ (umhos/cm)	Slope of best-fit line	R <sup>2</sup> of best-fit line
1485 w/ ANN	21.9E06	339	0.86	0.87
1485 w/ G-model	52.4E06	525	0.68	0.88
1641 w/ ANN	12.6E06	258	0.98	0.91
1641 w/ G-model	27.2E06	378	0.71	0.94

For both base studies (D-1485 and D-1641) at Jersey Point the slope of the best-fit lines for the ANN results more closely match the equivalent EC line. The scatter associated with D-1485 is about the same using both the ANN and G-model. The scatter associated with the G-model results about the best-fit lines is less (as seen by higher R<sup>2</sup> values) than the ANN scatter for the D-1641 study. However, as shown in Figures 4.23 and 4.25, while the G-model results generally represent a marginally tighter fit to the best-fit line, the G-model systematically underestimates EC for both studies. Furthermore, as discussed above, the MSE for the ANN is significantly lower in both studies than the MSE for the G-model results. Overall, the ANN resulted in a better fit of the equivalent EC line than the G-model.

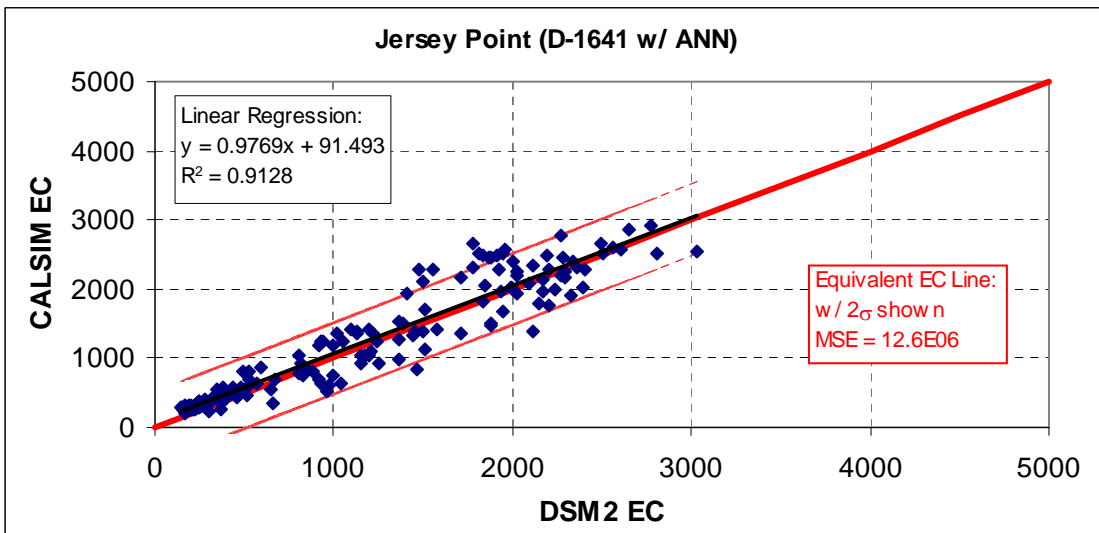


**Figure 4.22: Scatter Plot of CALSIM II with ANN EC versus DSM2 EC for D-1485 at Jersey Point.**

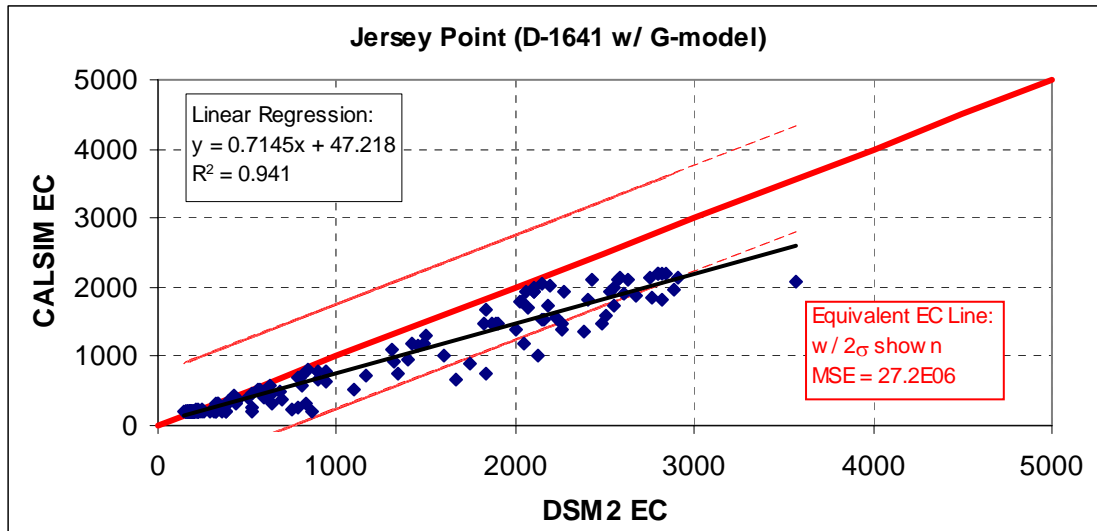




**Figure 4.23: Scatter Plot of CALSIM with G-model EC versus DSM2 EC for D-1485 at Jersey Point.**



**Figure 4.24: Scatter Plot of CALSIM with ANN EC versus DSM2 EC for D-1641 at Jersey Point.**



**Figure 4.25: Scatter Plot of CALSIM with G-model EC versus DSM2 EC for D-1641 at Jersey Point.**

#### 4.4.3 Rock Slough

The time series of EC at Rock Slough calculated by both DSM2 and CALSIM II is shown for all four studies in Figures 4.26, 4.28, 4.30, and 4.32. Time series of the difference of the CALSIM salinity estimates from the modeled DSM2 EC are shown in Figures 4.27, 4.29, 4.31, and 4.33. A summary of all of time series plots is listed in Table 4.6.

**Table 4.6: Rock Slough EC (rounded to the nearest 50 umhos/cm).**

DSM2 Study	DSM2 Max EC (umhos/cm)	CALSIM Max EC (umhos/cm)	Max Absolute Diff. in EC* (umhos/cm)
1485 w/ ANN	1950	950	1100
1485 w/ G-model	2000	950	1150
1641 w/ ANN	1000	1000	400
1641 w/ G-model	1300	950	350

\*This is the maximum absolute value of the difference in EC, and does not correspond with the timing of the maximum EC.

As shown in Table 4.6 for Rock Slough, both the ANN and G-model predicted maximum EC from CALSIM is about the same for both studies. As was discussed in Section 4.3.1, this is due to the fact that CALSIM uses the Rock Slough salinity standard as one of its salinity constraints while making water allocation decisions. However, as shown by the maximum EC in both D-1485 studies, CALSIM underestimated the DSM2 EC. The maximum absolute difference in EC between CALSIM and DSM2 was significantly lower in D-1641.

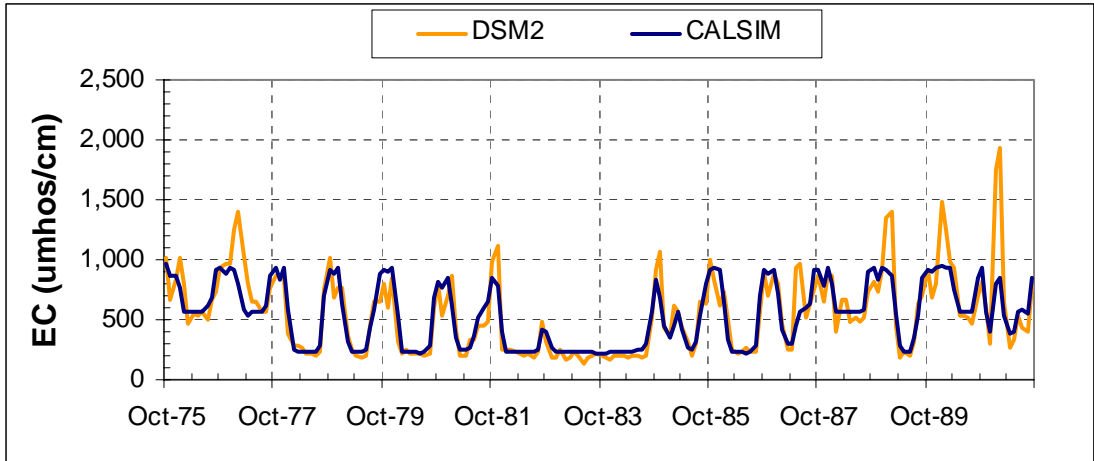


Figure 4.26: DSM2 versus CALSIM EC at Rock Slough for D-1485 using ANN.

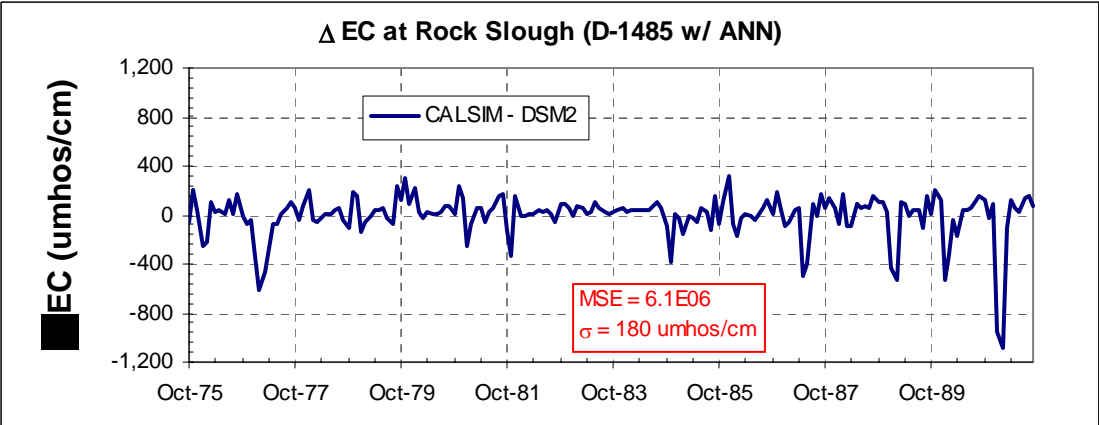


Figure 4.27: Difference in EC at Rock Slough for D-1485 using ANN.

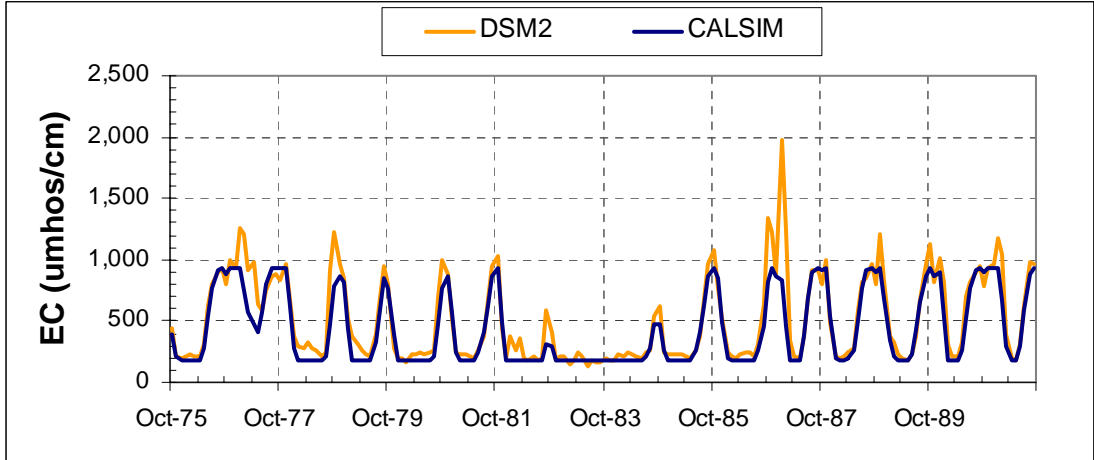
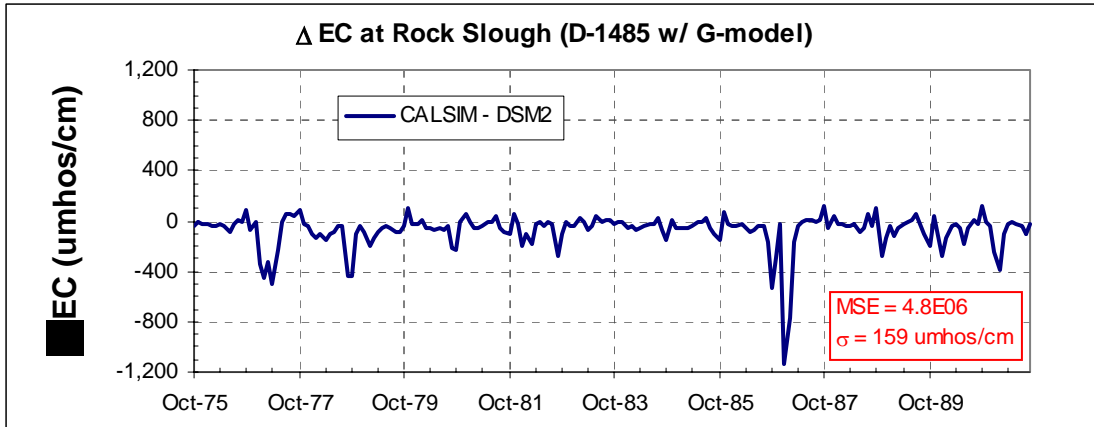
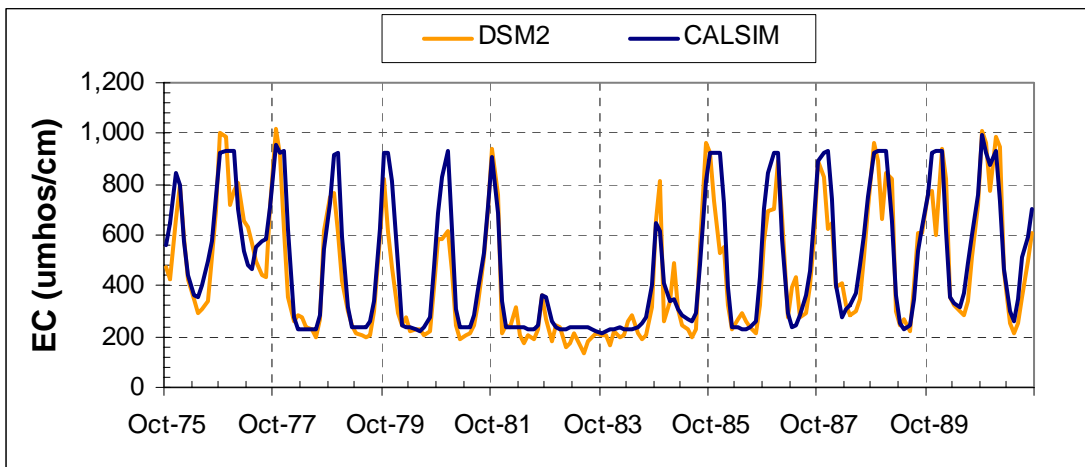


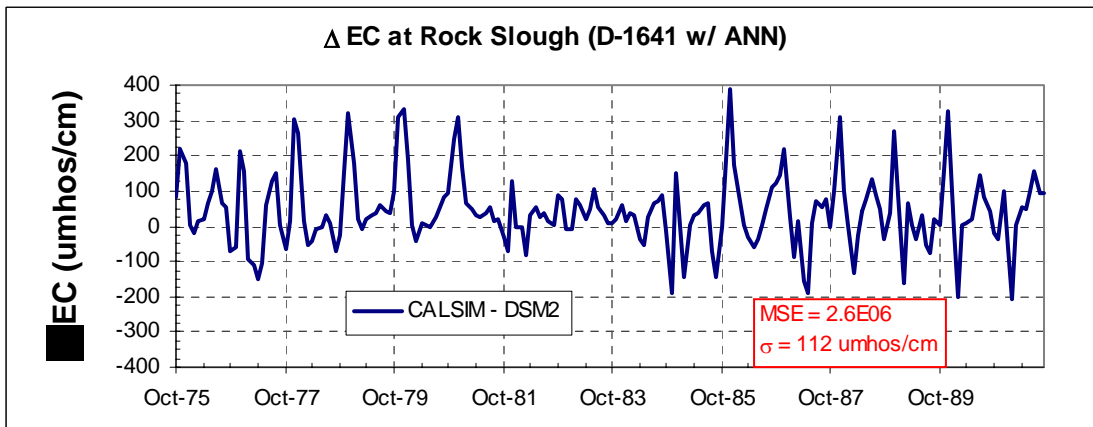
Figure 4.28: DSM2 versus CALSIM EC at Rock Slough for D-1485 using G-model.



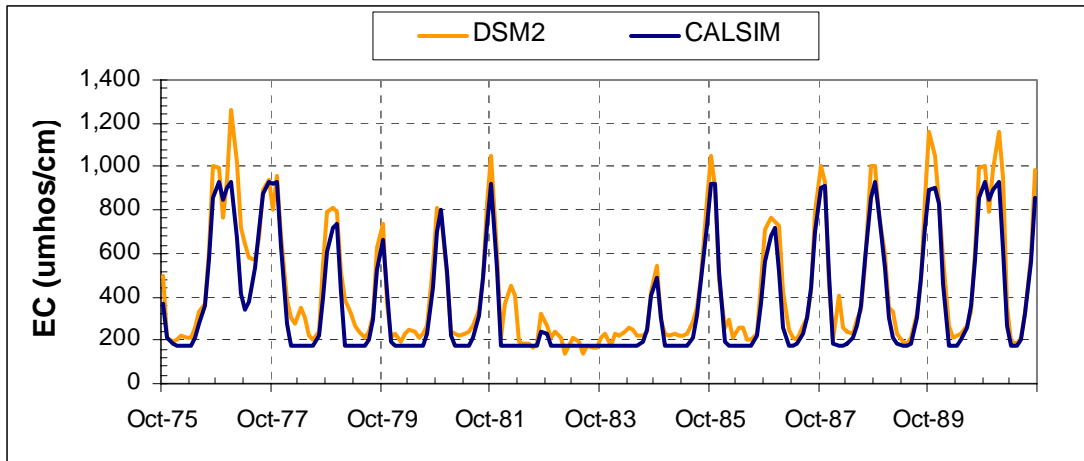
**Figure 4.29: Difference in EC at Rock Slough for D-1485 using G-model.**



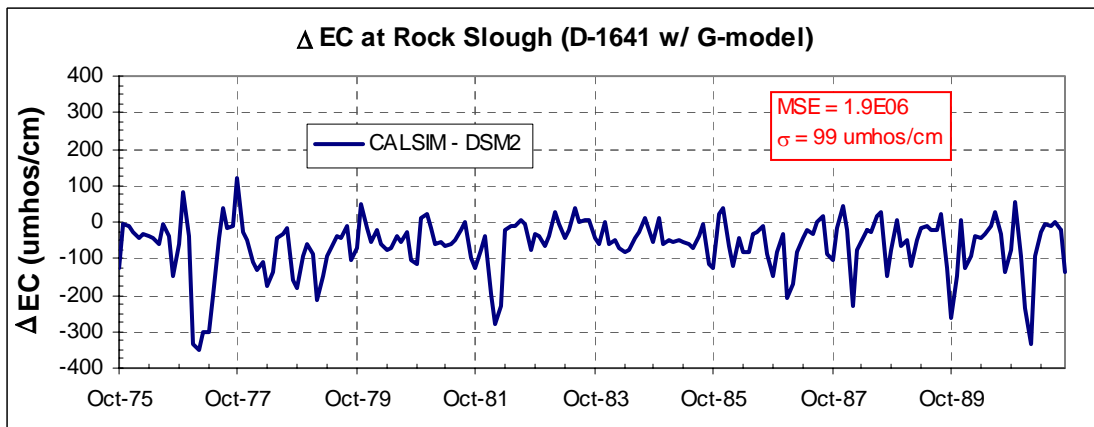
**Figure 4.30: DSM2 versus CALSIM EC at Rock Slough for D1641 using ANN.**



**Figure 4.31: Difference in EC at Rock Slough for D-1641 using ANN.**



**Figure 4.32: DSM2 versus CALSIM EC at Rock Slough for D-1641 using G-model.**



**Figure 4.33: Difference in EC at Rock Slough for D-1641 using G-model.**

Scatter plots illustrating the relationship between DSM2 EC and CALSIM EC at Rock Slough for each of the four studies are shown in Figures 4.34 – 4.37. An equivalent EC line is shown on each figure. Data will fall above the equivalent EC line when CALSIM is over predicting DSM2 EC. Similarly, data will fall below the equivalent EC line when CALSIM is under predicting DSM2 EC. Estimates representing two standard deviations above and below this equivalent EC line are also shown. Best-fit lines based on simple linear regressions of the EC data, along with the regression statistics, are also shown on each plot.

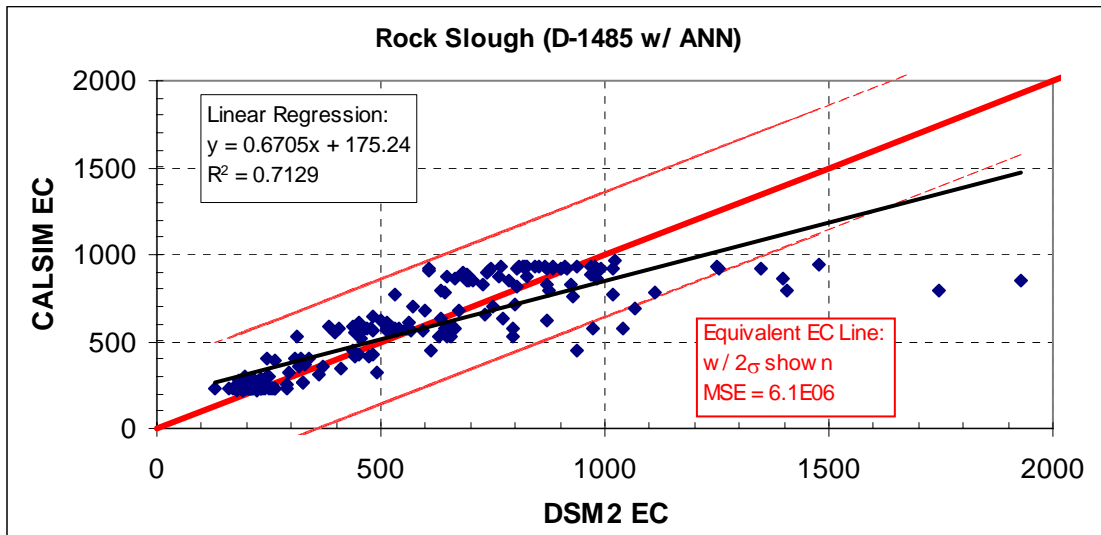
A summary of the regression statistics for all of the Rock Slough scatter plots is shown in Table 4.7. A complete discussion of how these regression statistics were calculated and what they represent is described in Section 4.4.1.

**Table 4.7: Summary of Rock Slough Scatter Plots.**

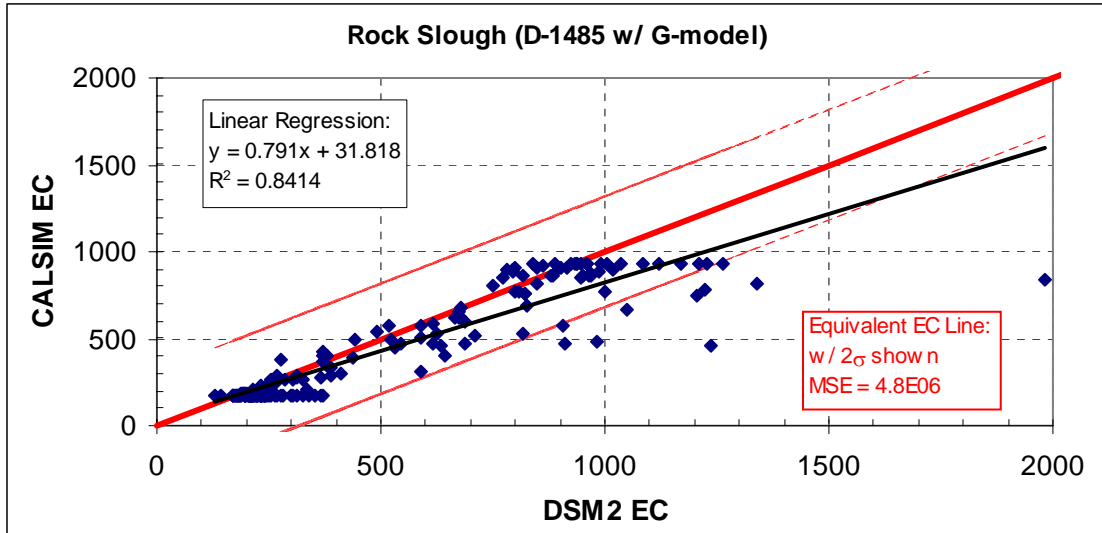
DSM2 Study	MSE	$\sigma$ (umhos/cm)	Slope of best-fit line	R <sup>2</sup> of best-fit line
1485 w/ ANN	6.1E06	180	0.67	0.71
1485 w/ G-model	4.8E06	159	0.79	0.84
1641 w/ ANN	2.6E06	112	0.97	0.84
1641 w/ G-model	1.9E06	99	0.89	0.93

For both studies (D-1485 and D-1641) at Rock Slough the G-model resulted in a tighter fit of the MSE and estimated standard deviation of EC about the equivalent EC line. However, the MSE for the ANN for D-1641 was lower than the MSE for the G-model for D-1485. Overall, D-1641 had a much lower MSE and estimated standard deviation. The scatter associated with the G-model results about the best-fit lines also is less (as seen by higher R<sup>2</sup> values) than the ANN scatter for both studies. While the slope of the best-fit line for the G-model results is closer to the equivalent EC line for D-1485, the ANN results represent a better fit to the equivalent EC line for D-1641.

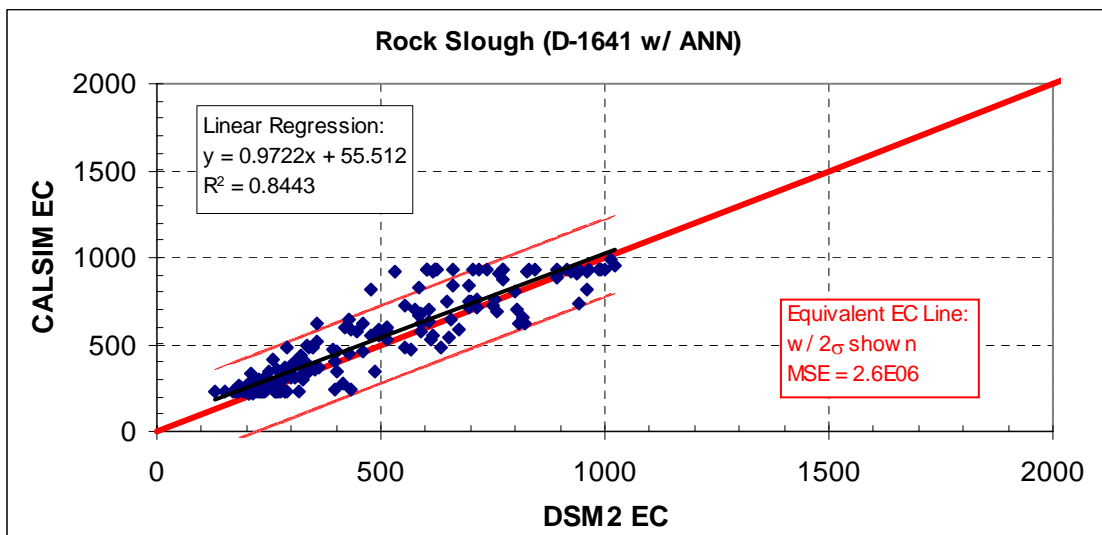
In the D-1485 study at Rock Slough both the G-model and ANN had some obvious outliers (see Figures 4.34 and 4.35). Removal of these outliers would shift the slope of the best-fit line closer to the equivalent EC lines as well as increase the R<sup>2</sup> value closer to 1.0.



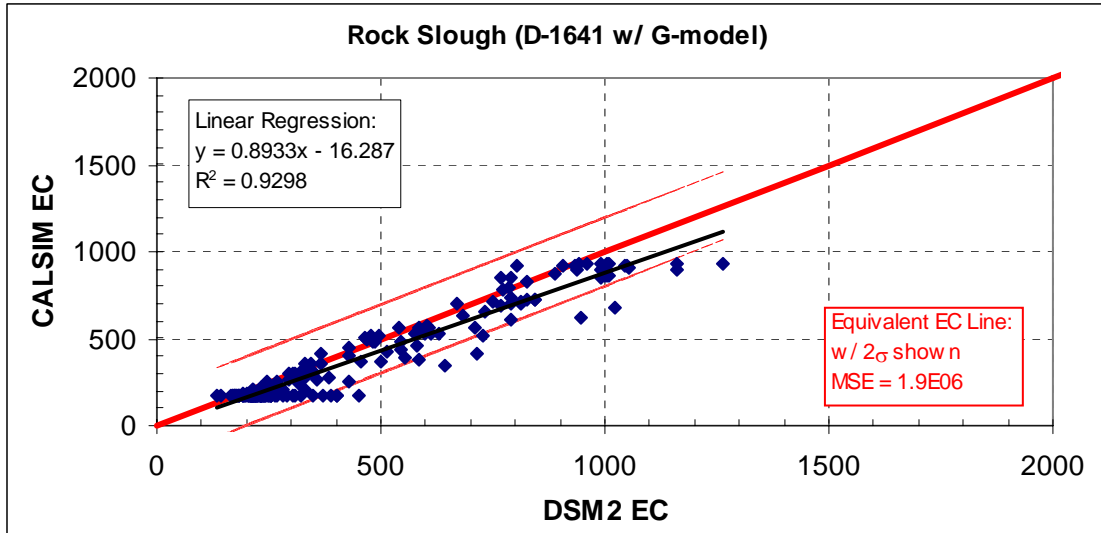
**Figure 4.34: Scatter Plot of CALSIM with ANN EC versus DSM2 EC for D-1485 at Rock Slough.**



**Figure 4.35: Scatter Plot of CALSIM with G-model EC versus DSM2 EC for D-1485 at Rock Slough.**



**Figure 4.36: Scatter Plot of CALSIM with ANN EC versus DSM2 EC for D-1641 at Rock Slough.**



**Figure 4.37: Scatter Plot of CALSIM with G-model EC versus DSM2 EC for D-1641 at Rock Slough.**

## 4.5 Conclusions

The results presented in this study focused on comparing the statistical results of the EC estimated in CALSIM by the G-model with the results of the EC estimated in CALSIM by an ANN that has been trained using DSM2. The hydrology from each CALSIM study was then input into DSM2. The EC simulated by DSM2 was considered the theoretical EC, thus allowing the differences between the DSM2 EC to be taken from the CALSIM estimated EC for each simulation. The resulting statistics of these differences were then used to compare the impact of using the ANN versus the G-model to estimate EC within CALSIM.

A summary of the results for each location is presented below:

### Emmaton

- ❑ The D-1485 CALSIM study using the ANN had the lowest MSE of the difference of EC, 11.2E06; the lowest estimated standard deviation,  $\sigma$ , 243 umhos/cm; best slope, 0.94; and tightest fit about the best-fit line, with a  $R^2$  value of 0.95.
- ❑ For both water quality studies, D-1485 and D-1641, the ANN provided a better fit than the G-model to the equivalent EC line (point at which CALSIM and DSM2 are equal).
- ❑ The G-model results systematically underestimated the theoretical EC calculated by DSM2.



## Jersey Point

- ❑ The D-1641 CALSIM study using the ANN had the lowest MSE of the difference of EC, 12.6E06; the lowest estimated standard deviation,  $\sigma$ , 258 umhos/cm; and best slope, 0.98.
- ❑ The D-1641 CALSIM study using the G-model had tightest fit about the best-fit line, with a  $R^2$  value of 0.94.
- ❑ For both water quality studies, D-1485 and D-1641, the ANN provided a better fit than the G-model to the equivalent EC line (point at which CALSIM and DSM2 are equal).
- ❑ The G-model results systematically underestimated the theoretical EC calculated by DSM2.

## Rock Slough

- ❑ The D-1641 CALSIM study using the G-model had the lowest MSE of the difference of EC, 1.9E06, the lowest estimated standard deviation,  $\sigma$ , 99 umhos/cm, and tightest fit about the best-fit line, with a  $R^2$  value of 0.93.
- ❑ The D-1641 CALSIM study using the ANN had best slope fit about the best-fit line, 0.97.
- ❑ Though the G-model provided a tighter fit to its estimated best-fit lines than the ANN model did to its own best-fit lines for both studies, the presence of outliers in the D-1485 study make it difficult to critique the performance of either model for that study.
- ❑ The G-model results still underestimated the theoretical EC calculated by DSM2.

At all three locations the G-model systematically underestimated EC. With the exception of Rock Slough, the ANN results represented a tighter fit about the theoretical EC values, as measured by lower MSE values. At Rock Slough, the G-model did provide a better fit to the theoretical EC values; however, it is important to note that the differences of the estimated standard deviations between the G-model (99 umhos/cm for D-1641) and ANN (112 umhos/cm for D-1641) were small. It is interesting to note that although the ANN was trained on D-1485 operations, that generally D-1641 operations resulted in better estimations of EC for both the G-model and ANN.

## 4.6 References

Denton, R. and G. Sullivan. (1993.) *Antecedent Flow-Salinity Relationships: Applications to Delta Planning Models*. Contra Costa Water District.

Wilbur, R., and A. Munevar. (2001). "Chapter 7: Integration of CALSIM and Artificial Neural Network Models for Sacramento-San Joaquin Delta Flow-Salinity Relationships." *Methodology for Flow and Salinity Estimates in the Sacramento-San Joaquin Delta and Suisun Marsh*. 22<sup>nd</sup> Annual Progress Report to the State Water Resources Control Board. California Department of Water Resources. Sacramento, CA.