

**ABUNDANCE AND SURVIVAL
OF
JUVENILE CHINOOK SALMON
IN THE
SACRAMENTO-SAN JOAQUIN ESTUARY**



**1997 and 1998 ANNUAL PROGRESS REPORTS
SACRAMENTO-SAN JOAQUIN ESTUARY
FISHERY RESOURCE OFFICE,
U.S. FISH AND WILDLIFE SERVICE
STOCKTON, CALIFORNIA**

DECEMBER 2001



**Interagency
Ecological Program**
COOPERATIVE ECOLOGICAL
INVESTIGATIONS SINCE 1970

Table of Contents

Acknowledgments.....	ii
Introduction.....	1
Methods	5
Lower Sacramento River Beach Seine.....	14
Lower San Joaquin River Seine	19
Delta Juvenile Sampling	
Delta Beach Seine.....	21
Kodiak and Midwater Trawl at Sacramento.....	25
Kodiak Trawl at Mossdale.....	32
Midwater Trawl at Chipps Island.....	34
Bay Seine.....	40
Absolute Abundance Estimates.....	42
1997 Mark and Recapture Studies.....	47
1998 Mark and Recapture Studies.....	50
References	54
Appendix 1	56
Appendix 2	77

Acknowledgments

This sampling was conducted for and funded by the Interagency Ecological Program (IEP) for the Sacramento-San Joaquin Estuary. Members of the IEP include three state and six federal agencies: California Department of Water Resources, California Department of Fish and Game, State Water Resources Control Board, U.S. Bureau of Reclamation, U.S. Geological Survey, U.S. Fish and Wildlife Service, National Marine Fisheries Service, U.S. Army Corps of Engineers, and the U.S. Environmental Protection Agency.

Introduction

Work in 1997 and 1998 by the Sacramento-San Joaquin Estuary Fishery Resource Office (SSJEFRO - changed to the Stockton Fish and Wildlife Office in 2001) was conducted to update and refine our knowledge of the factors influencing juvenile salmon abundance, distribution, and survival in the Sacramento-San Joaquin Estuary. Field sampling and special studies were conducted between August 1, 1996, and July 31, 1998, (referred to as the 1997 and 1998 field seasons) with various sampling gears as juveniles rear and migrate through the lower Sacramento and San Joaquin Rivers, Delta, and the San Francisco - San Pablo Bay.

Objectives of the 1997 and 1998 Interagency Salmon Study were to:

- Monitor the relative abundance, distribution, and timing of juvenile chinook salmon rearing and migrating through the lower Sacramento River, the Delta, and portions of the San Francisco Bay.
- Determine relative survival (using fall and late-fall hatchery smolts) of juvenile salmon released in the upper river and Delta, and identify potential factors influencing survival.

Midwater trawling, Kodiak trawling, and beach seining were employed at varying times and locations in the Delta, lower Sacramento and San Joaquin rivers, and parts of the San Francisco Bay. Different sized juveniles of the various races of chinook salmon presumably have distinct spatial and temporal distributions making them vulnerable to different gear types. Although the largest juveniles (greater than 150 mm) probably are not effectively sampled using the gears employed by this office, the salvage facilities in the South Delta catch larger sized juveniles helping us to further understand the abundance, and distribution of juvenile salmon.

Water Conditions During Study

The 1997 and 1998 water years were classified as wet years, but each exhibited completely different outflow patterns.

The 1997 water year included an extremely large flood event associated with two warm weather storms in late-December and early-January (Knowles et al. 1997). After several smaller storms in January the rainfall dropped off considerably resulting in one of the driest February and March rainfalls on record. As a result, Delta outflow between December 30 and February 9, 1997, was nearly four times the mean volume of the bay (Knowles et al. 1997), producing highly turbid, debris riddled water. Rainfall during the 1998 water year provided above average precipitation between January and June. In addition, cool temperatures delayed peak snowmelt until early July keeping streamflows above normal well into the summer (Knowles et al. 1998).

Race Designation by Size

The SSJEFRO uses size and date of capture to determine juvenile chinook salmon race in the lower Sacramento River and Delta. At this time it is the only tool used to determine race of juvenile salmon in the field. Several problems exist regarding the validity of this method that have been discussed in past reports (USFWS, 1995). For these reasons, the race designations used in this report should only be used as a rough approximation and not interpreted as definitive. Genetic differentiation of races is promising and may help determine true race of Central Valley salmon juveniles in the future.

Although all four races are designated in the field using the size criteria, for this report the fall and spring run categories have been combined into a group identified as fall/spring run, since there is a question as to whether spring run are true spring run chinook or faster growing fall run.

Life Stage Delineation

Because designations of the various life stages of juvenile chinook depend on the physiological state of the fish, the use of fork length does not clearly define these stages but can be a rough estimate of this classification. For this report fry is defined as being less than 70 mm fork length. Juveniles larger than fry are likely starting to undergo behavioral and physiological changes to prepare them for the transition to salt water, and are defined as smolts (70 to 200 mm). Yearlings are defined as juveniles residing in freshwater approximately one year.

Escapement

To help understand the changes in abundance of the juvenile salmon populations in the Delta, graphs of the annual number of returning adults of each race passing Red Bluff Diversion Dam (RBDD) in the upper Sacramento River, and returns to the Coleman National Fish Hatchery are shown in Figure 1. For escapement estimates to be properly obtained, the RBDD gates must be in the closed position. Since 1993, this has not occurred during late-fall upstream migration.

To estimate late-fall run escapement, carcass surveys began in 1998. Between 1993 and 1998, returns to the Coleman National Fish Hatchery were used for the estimate. Fall/spring run returns in 1997 were the highest since 1969, while 1998 returns were the lowest since 1952. Winter run escapement continued to be low during 1997 and 1998 (Figure 1).

Fall run escapement in the American River was the sixth highest in 1997 and third highest in 1998 since 1978. Feather River fall run escapement was the third highest in 1997 since 1978, however, only Feather River hatchery escapements were available for 1998 (Figure 2).

Compared with escapement during the 1980's, the Stanislaus, Tuolumne and Merced River returns through the 1990's have been low (Figure 2).

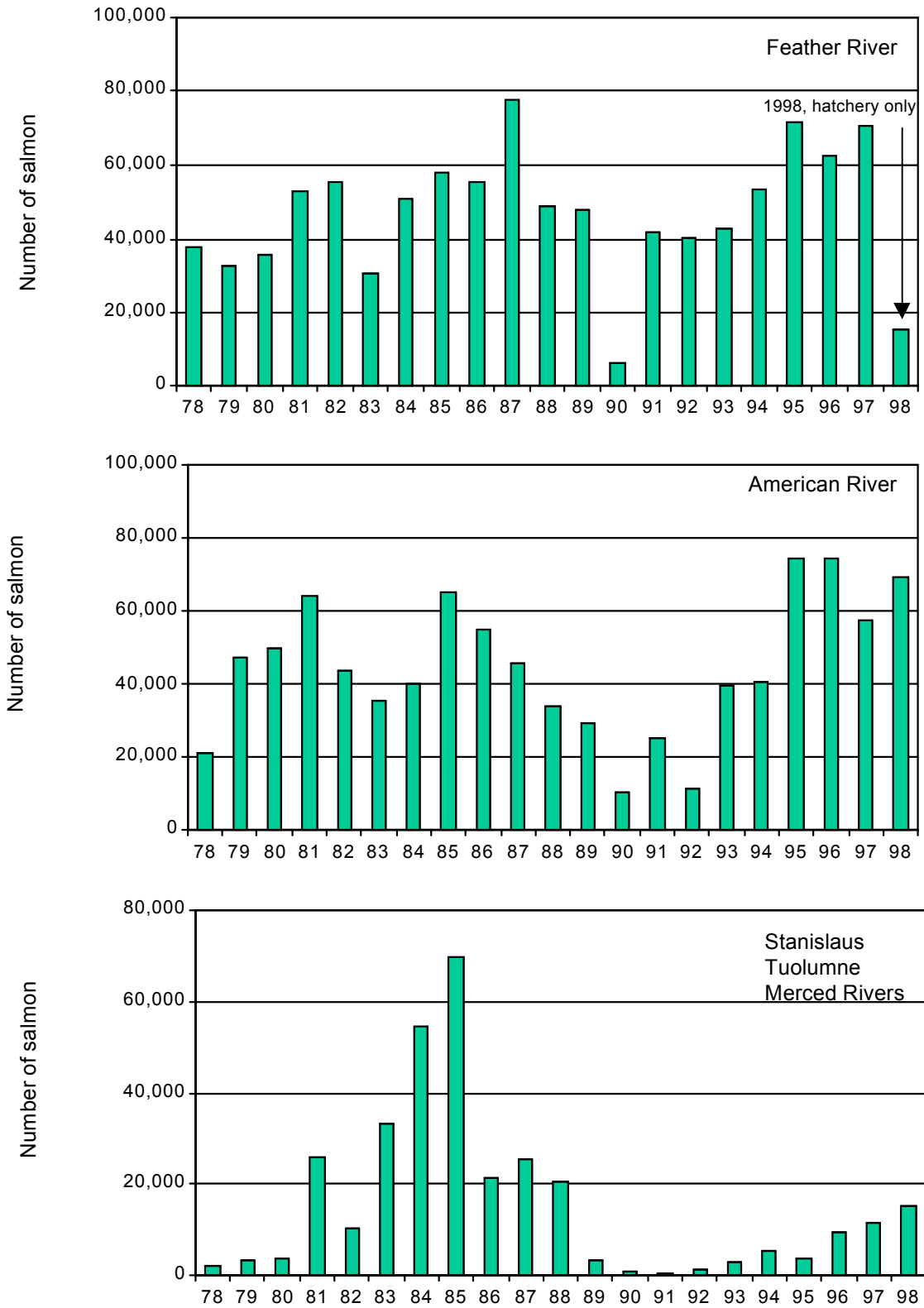
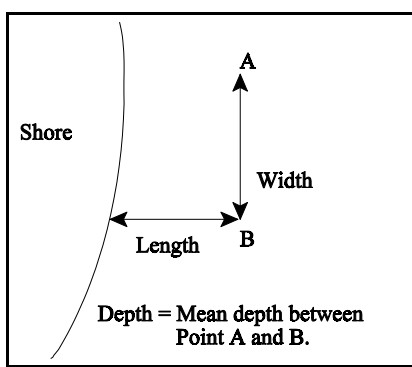

Figure 2. Spawner population estimates of fall run chinook salmon between 1978 and 1998 on the Feather and American Rivers, and the Stanislaus, Tuolumne, and Merced Rivers combined. Totals for each year are the sum of both in-river and hatchery totals.

Methods

Beach Seine

All seining was done with a 15 meter x 1.2 meter (50' x 4') 3 mm (1/8") delta square mesh beach seine with a 1.2 meter (4') long bag. One seine haul was attempted at each site (Figure 3). Seine sites consisted of cement boat ramps, sandy beaches, gravel bars, and muddy inlets. The majority of sites on the Sacramento River and Delta have been sampled since the mid-1970's to document the relative abundance of juvenile chinook salmon between and within years (Figures 4, 5, and 6). To determine relative abundance and spatial distribution of juvenile chinook in the Estuary, it is divided into seven regions: the lower Sacramento River (between Colusa and Elkhorn), Sacramento River at Sacramento (between Verona and Clarksburg), North Delta (Discovery Park to Antioch on the Sacramento River), Central Delta (between the San Joaquin River and Sacramento River), and South Delta (adjacent to and south of the San Joaquin River). The San Joaquin River (between Mossdale and Tuolumne River) and the Bay seine routes (downstream of Pittsburg to Tiburon in San Francisco Bay) were added in recent years (Figure 6).



Every attempt was made to seine the original historical sites to retain validity of year to year catch per unit of effort comparisons. Occasionally, changes in flow or excessive traffic prevented seining a site.

Before valid comparisons in abundance and timing within and between years were made, catches were corrected for effort by standardizing to catch per cubic meter (CPM³). Catch per cubic meter for each beach seine haul was calculated using the following equation, in meters (see diagram on left):

$$\text{Seine CPM}^3 = \text{Catch} / (.5) \text{ depth X width X length}$$

Figure 3 . Beach seine set.

Clarksburg Midwater Trawl

Though it is called a midwater trawl net due to its design, it is fished at the top of the water column. The midwater trawl net used at Sacramento is composed of six panels, each decreasing in mesh size towards the cod end (Figure 7). Fully extended mouth size is 1.8 meter x 4.6 meters (6' x 15') and mesh size range from 8 inch stretch at the mouth to 1/2 inch stretch just before the cod end. The cod end is composed of 1/4 inch weave mesh. Depressors, commonly referred to as bottom doors, are made of 1/4 inch stainless steel (one on each side of the bottom of the net) are attached to the net with shackles and connected to bridles with chain and then Miller Swivels. Hydrofoils, commonly referred to as top doors, are made with floats attached to them to spread the top of the net at the surface, and are attached using the same equipment as the depressors. One-hundred foot long galvanized cable bridles are attached to Miller Swivels and attached to the cable from the boat. The net is fished one-hundred feet from the boat (swivels are located just aft of the a-frame). Actual fishing dimensions of the net vary due to currents and weather conditions and have been estimated and described in past reports (USFWS, 1993).

Chippis Island Midwater Trawl

The larger midwater trawl net used at Chippis Island (Figure 8) is similar in construction to the midwater trawl net used at Sacramento but has a mouth dimension of 3 meters x 9 meters (10'x30'). The six panels making up the net, have decreasing mesh size towards the cod end. Mesh sizes ranged from 4 inch to 1/2 inch stretch just before the cod end. The cod end was composed of 5/16 inch knotless material. Depressors and hydrofoils were connected in the same manner as with the smaller Sacramento midwater trawl. The net is fished one-hundred and fifty feet behind the of the vessel.

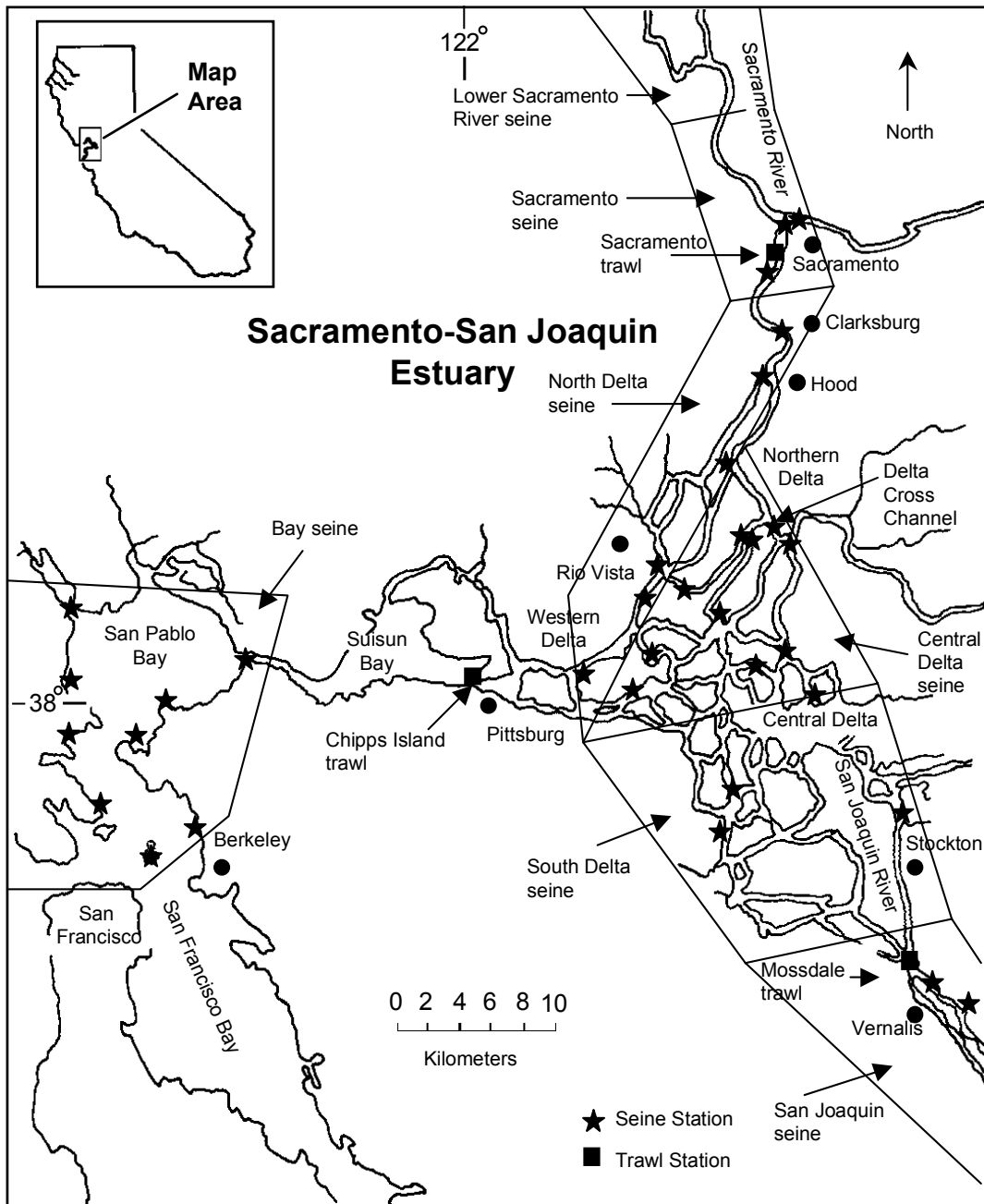

Figure 4. Sampling sites used during the 1997 and 1998 field seasons in the Sacramento-San Joaquin Estuary. Beach seine and trawl recovery locations are marked with stars and squares respectively. The bordered areas show each beach seine region. Note: not all of the seine sites are shown within each region.

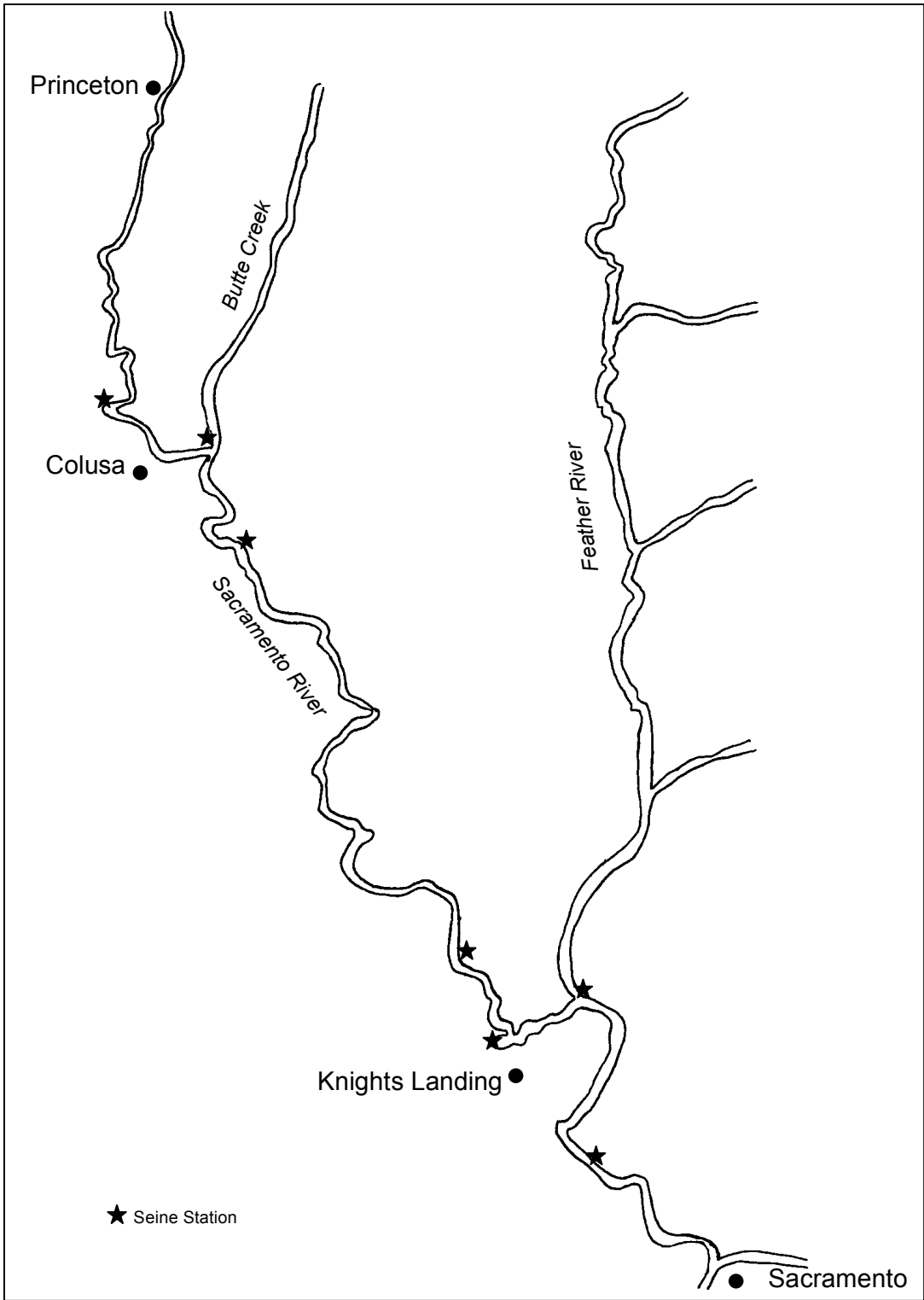

Figure 5. Lower Sacramento River beach seine sites sampled during the 1997 and 1998 sampling seasons by the SSJEFRO.

<u>Lower Sacramento River Seine</u>		<u>North Delta Seine</u>	
SR144W	Colusa State Park	SR060E	Discovery Park
SR138E	Ward's Landing	SR049E	Garcia Bend
SR130E	South Meridian	SR043E	Clarksburg
SR094E	Reels Beach	SS011N	Steamboat Sl.
SR090W	Knights Landing	SR024E	Koket
SR080E	Verona	SR017E	Isleton
SR071E	Elkhorn	SR014W	Rio Vista
<u>Central Delta Seine</u>		AM001S	American River
LP003E	Terminous	SR012E	Stump Beach
XC001N	Delta Cross Channel	MS001N	Sherman Island
GS010E	Georgiana Slough	<u>South Delta Seine</u>	
SF014E	Wimpy's	TC002E	Turner Cut
MK004W	B&W Marina	SJ032S	Lost Isle
DS002S	King's Island	OR003W	Franks Tract
SJ005NE	Eddo's	SJ026N	Venice Island
TM001N	Brannon Island	WD002W	Veale Tract
SJ001S	Antioch Dunes (Antioch Dunes National Wildlife Refuge)	OR014W	Crusier Haven
<u>San Joaquin Seine</u>		OR019E	Old River
SJ041N	Dad's Point	MR010W	Woodward Island
SJ051E	Dos Reis	<u>Sacramento Seine</u>	
SJ056E	Mossdale	SR080E	Verona
SJ058W	Wetherbee	SR071E	Elkhorn
SJ063W	Big Beach	SR062E	Sand Cove
SJ068W	Durham	SR060E	Discovery Park
SJ074W	Sturgeon Bend	SR057E	Miller Park
SJ077E	Route 132	SR055E	Sherwood Harbor
SJ083W	North of Tuolumne River	SR049E	Garcia Bend
SJ086W	Grayson	SR043E	Clarksburg
<u>Bay Seine (West)</u>		<u>Bay Seine (East)</u>	
SA010W	San Quentin	SA001M	Treasure Island
SA004W	Tiburon	SA007E	Berkeley Frontage
SA008W	Paradise Beach	SP000E	Pt. Molate
SP001W	China Camp	SA009E	Keller Beach
SP000W	McNear's Beach	SP003E	Point Pinole East
		<u>Trawls</u>	
		SB018	Chippis Island
		SJ054M	Mossdale
		SR055M	Sacramento

Figure 6. Station codes and names for all gears used by SSJEFRO in 1997 and 1998. The beach seine sites in the Lower Sacramento River sampling area are upstream of the city of Sacramento on the Sacramento River (RM 60). The North Delta seine sites are south of Sacramento on the Sacramento River. The Central Delta seine sites are between the Sacramento and San Joaquin Rivers and the South Delta seine sites are located in the interior Delta south of the San Joaquin River. The San Joaquin River seine sites are upstream of Dos Reis Park (RM 51) on the San Joaquin River. The Sacramento seine ranges from Verona (RM 80) to Clarksburg (RM 43) on the Sacramento River and includes three additional sites in the Sacramento area: Sand Cove, Miller Park, and Sherwood Harbor. Bay seine sites are west of Pittsburg to McNear's Beach (SF Bay).

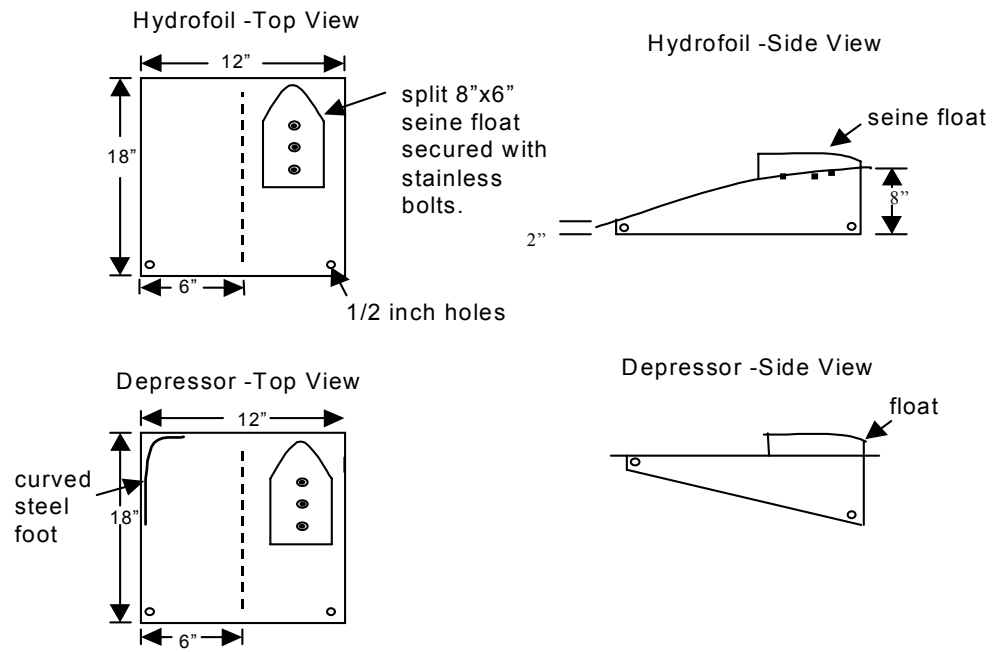
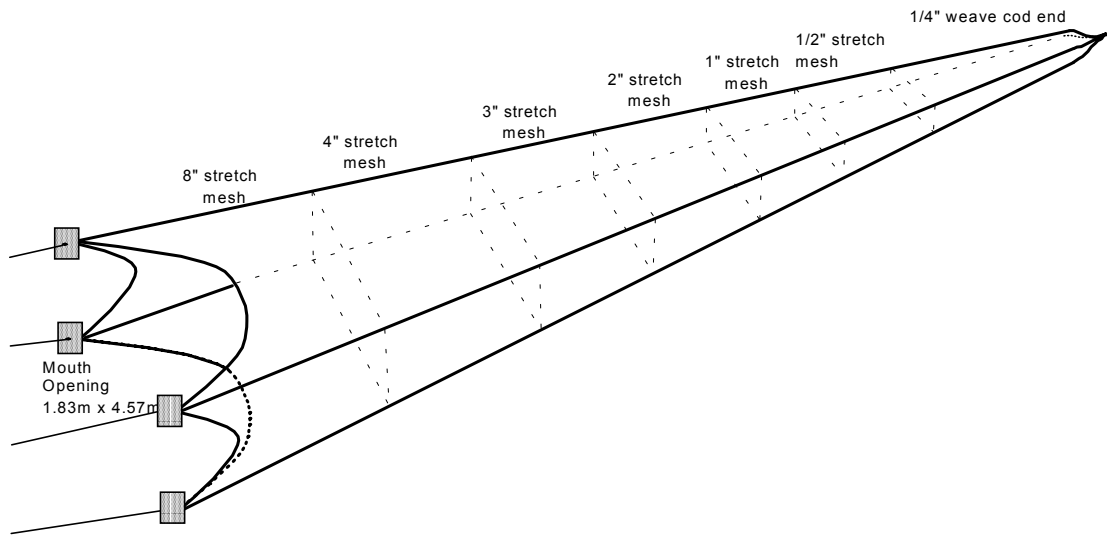

Figure 7. Schematic drawing of the midwater trawl net (top), and depressors and hydrofoils (bottom) used at Sacramento during the 1997 and 1998 field seasons.

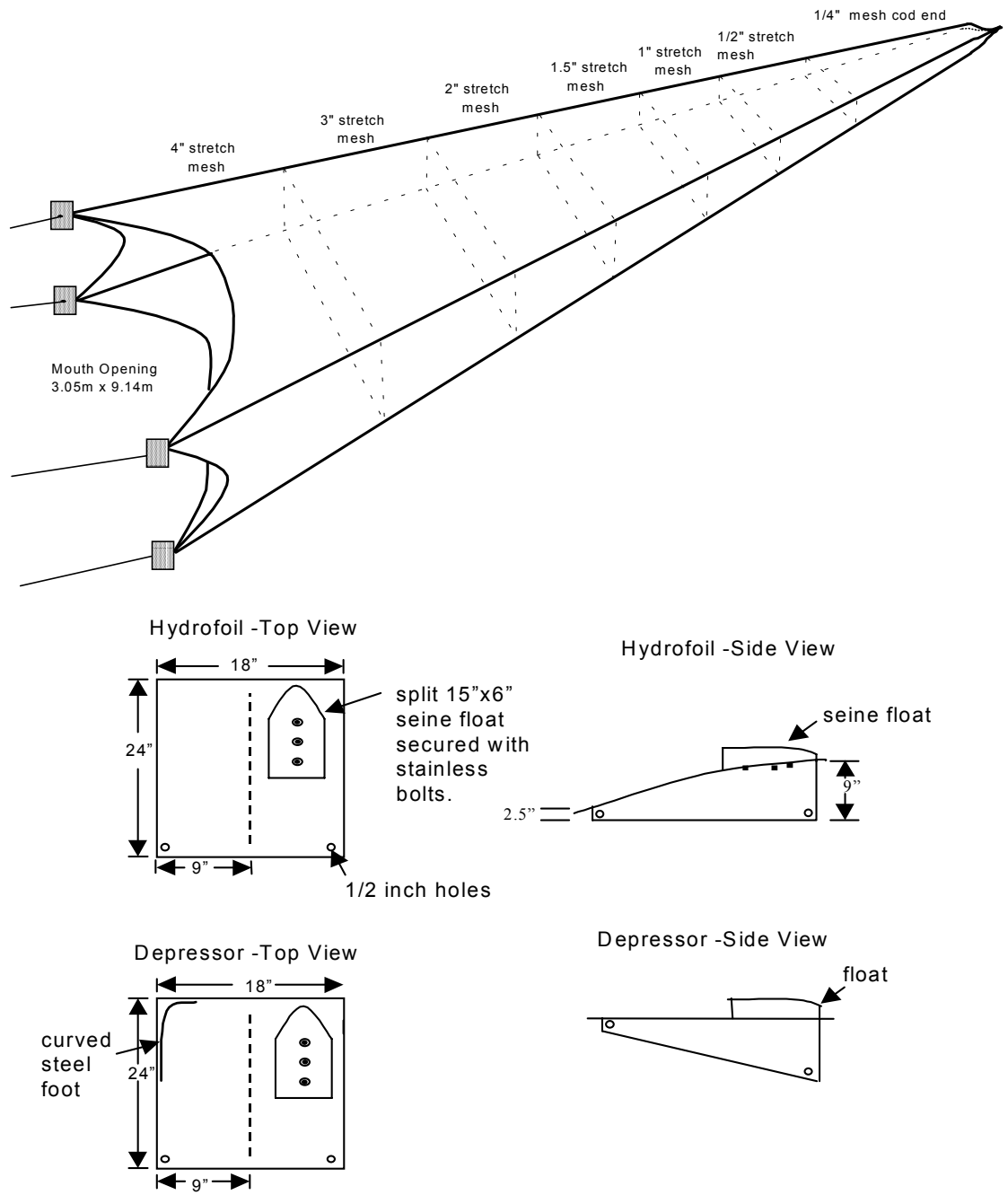

Figure 8. Schematic drawing of the midwater trawl net (top), and depressors and hydrofoils (bottom) used at Chipps Island during the 1997 and 1998 field seasons.

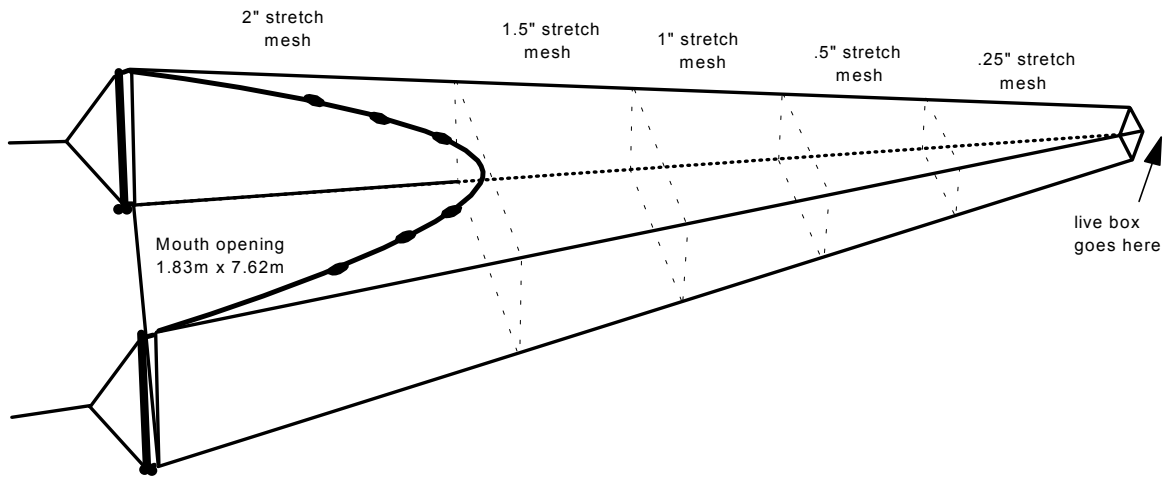

Figure 9. Schematic drawing of the Kodiak trawl net used at Sacramento during the 1997 and 1998 field season.

Ten twenty minute trawls were done per sample day at both locations. All trawling at Sacramento was done in the middle of the channel facing upstream against the current within 1.5 kilometers of the sample site. Trawling at Chipps Island also was done within 1.5 kilometers from the sample site in both directions depending on the tide, and in three channel locations: north, south, and middle. Occasionally, inclement weather, mechanical problems, or excessive fish catches required reducing tow times or the number of tows per day.

The net mouth area in the small and large midwater trawl nets used for calculations were estimated net mouth fishing areas. Previous studies showed that the midwater trawl nets don't typically open completely while under tow (USFWS, 1993) and that mouth dimensions vary within and between tows. Catch by cubic meter (CPM³) per tow in the midwater trawl was calculated with the following formula:

$$\frac{\text{catch per tow}}{\text{net mouth area (m}^2\text{) X distance net passes through water column(m)}}$$

Estimated net mouth areas used in this report were the mean mouth openings calculated from these studies. The estimated net mouth areas while fishing were 5.1 square meters for the small midwater trawl used at Sacramento and 18.6 square meters for the large midwater trawl used at Chipps Island. The distance the net passes through the water column defined in meters was measured during each tow with a General Oceanics mechanical flow meter (model 2030). Total revolutions per tow were counted by the flow meter and converted to linear distance using standard equations as described by General Oceanics reference manual. This is a measurement of the distance the net travels through the water and is not related to distance traveled relative to land which can be effected by tides and currents.

Sacramento and Mossdale Kodiak trawl

The Kodiak trawl net also is variable mesh with a fully expanded mouth opening of 1.8 x 7.6 meters (6 x 25 feet) and is shown in Figure 9. The estimated fishing net mouth area, extrapolated from midwater trawl studies (USFWS, 1993), is 12.5 square meters for the Kodiak trawl. A float line and lead line enable the net to fish the top 1.8 meters of the water column. At the front of each wing is a 1.8 meter bar keeping this depth constant. The Kodiak trawl is fished with an aluminum live box as a cod end to avoid excessive fish mortality. Two boats tow the Kodiak net through the water at the surface, one pulling each wing. At the end of each tow, the boats come together, the tow rope from the work boat is passed to the net boat, then the work boat retrieves the live box from the cod end of the net and removes the fish. The method used to calculate CPM³ per tow is the same as the midwater trawl.

Daily, weekly, and monthly CPUE calculations

Data was summarized using monthly CPM³ values. The average monthly CPM³, unless otherwise specified, was calculated based on the daily and weekly averages as shown in the following formulas.

$$\text{Average Daily CPM}^3 = \frac{\sum_{i=1}^3 (\text{site/tow CPM}^3)}{\# \text{ sites/tows sampled in each day}}$$

$$\text{Average Daily by Week CPM}^3 = \frac{\sum_{i=1}^3 (\text{daily CPM}^3)}{\# \text{ days sampled in each week}}$$

$$\text{Average Daily by Month CPM}^3 = \frac{\sum_{i=1}^3 (\text{weekly CPM}^3)}{\text{\# weeks sampled in each month}}$$

The monthly CPM³ was the sum of weekly CPM³ divided by the number of weeks sampled per month. Weeks were designated as Monday-Sunday and weeks which overlap months were split and included in their respective months. Each average weekly CPM³ was calculated by averaging all daily means within the week. The daily CPM³ was the average of all tows for trawl and all sites for seine for each day.

Lower Sacramento River Beach Seine

To estimate the relative abundance of juvenile chinook salmon in the lower Sacramento River, beach seining was conducted at nine sites once per week from August 1, 1996, through July 31, 1998. The area sampled was from Colusa (rm 144) downstream to Elkhorn (rm 71). The substrates sampled were sand and paved boat ramps.

1997 Field Season

The most abundant race captured in the lower Sacramento River during the 1997 field season was fall/spring. Fall/spring are typically smaller than late-fall or winter run when leaving the lower river and are more vulnerable to capture in the seine than the other races because of their small size and apparent preference for shoreline habitat. The high susceptibility of fall/spring to capture in the seine and their relatively high abundance compared to other races in the Central Valley make them very prominent in beach seine catches. Size ranged between 31 and 88 mm fork length and catches occurred between December 1, 1996, and June 25, 1997. Many fry were captured during the high flow period in January, February and March. This is consistent with past seasons when the majority of the fall/spring have been captured during this three month period. Larger, smolt sized fall/spring run were captured between February and June (Figure 10 and Table 1).

Late-fall spawning generally occurs between January and late-April. Juveniles enter the Delta as fry in the spring or as yearlings in the following fall/winter. A total of 7 late-fall smolts were captured between November 26, 1996, and December 26, 1996, from the 1996 brood year (BY). Size ranged between 92 and 126 mm fork length. Peak CPM³ was in December during the first high flow event of the season. Unlike the previous four years, brood year 1997 fry were not detected in the spring of 1997 (Figure 10, 11 and Table 2).

A total of 45 winter run were captured in the lower Sacramento River beach seine during the 1997 field sampling year between December 4, 1996, and March 11, 1997. Catches were greatest in December and January, with mean daily catch per unit considerably higher during January. Chinook were detected at the beginning of the high flows, and again as flows receded. Very little sampling was accomplished during February due to flooding (Figure 10 and Table 3).

1998 Field Season

Fall/spring were again the most abundant race captured in the lower Sacramento River during the 1998 field season. Like 1997, highest densities occurred during high flows in January, but unlike 1997, catches occurred into July. Size ranges were between 31 and 88 mm fork length and catches occurred between December 1, 1997, and July 13, 1998 (Figure 12 and Table 1).

Catches of late-fall juveniles in the lower Sacramento River beach seine during the 1998 field season included juveniles from 1997 (smolts) and 1998 (fry). A total of 13 late-fall smolt sized chinook were captured between December 1, 1997, and January 14, 1998, ranging between 91 and 173 mm fork length. As shown in Table 2, peak densities occurred in December. A total of nine late-fall fry from the 1998 brood year were captured between May 1, 1998, and June 25, 1998, two in May and seven in June (36 to 54 mm). While catch per cubic meter was higher in 1998 for BY 97 and BY 98, the trend of detecting the smolt size fish (BY 97) over a shorter period continued (Figure 11, 12 and Table 2).

A total of 132 winter run were captured in the lower Sacramento River between November 18, 1997, and January 30, 1998. Fork lengths ranged from 57 to 118 mm. Figure 10 shows breaks between catches of winter run when flows were dropping. The period of capture and peak catch per cubic meter occurred during December (Figure 12 and Table 3).

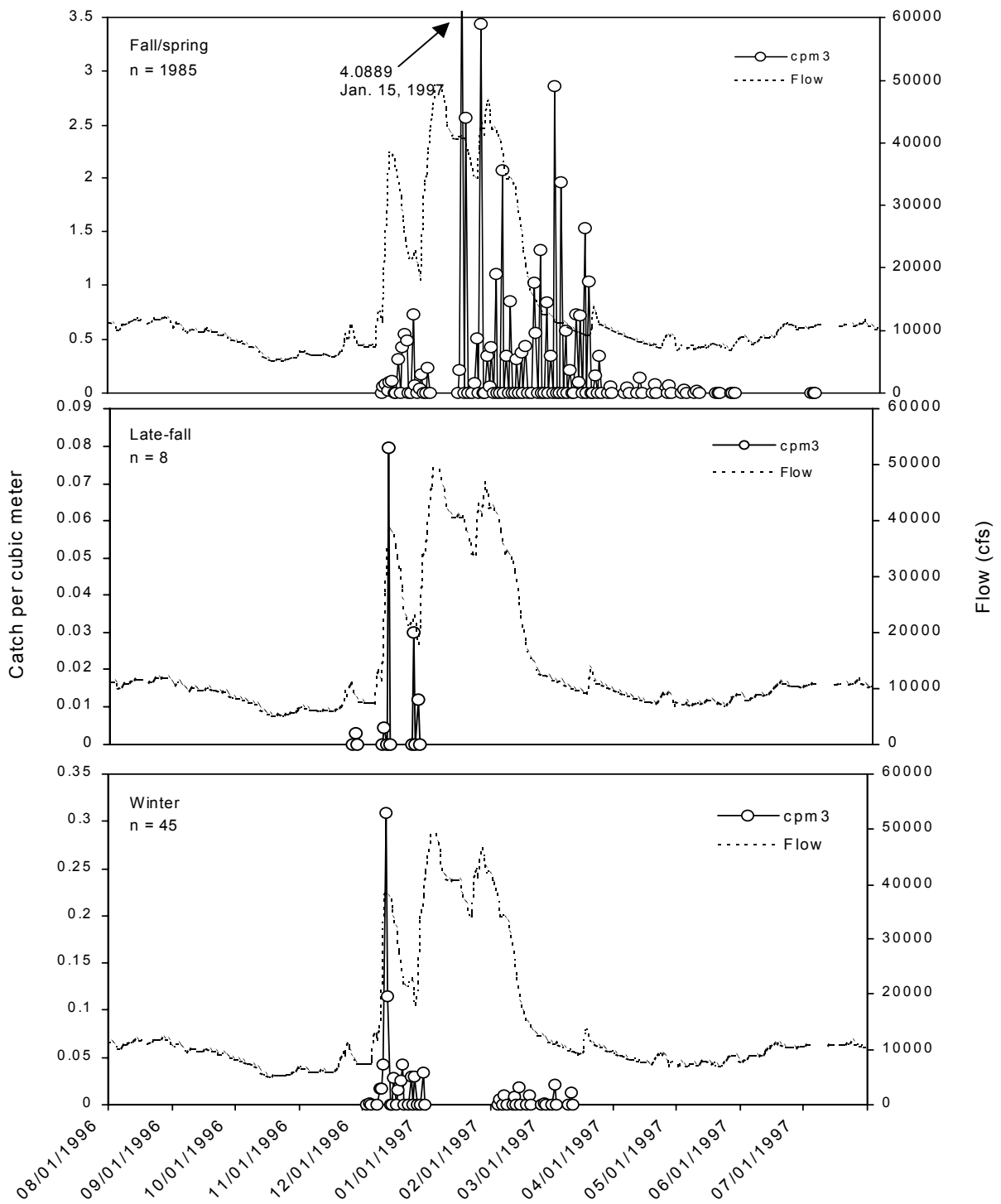

Figure 10. Daily catch per cubic meter in the lower Sacramento River beach seine during the 1997 field season, and flow measured at Colusa (cfs).

Table 1. Lower Sacramento River beach seine **fall/spring run** raw catch, catch per cubic meter times 100 (in parenthesis), and maximum monthly statistics for each year for the 1993 through 1998 field seasons. Peak catch per cubic meter values are highlighted. Average (Aver) catch and CPM³ per month are also shown. NS = no sample.

Field season	Aug	Sep	Oct	Nov	Dec	Jan	Feb	Mar	Apr	May	Jun	Jul	Aver
1992 - 1993	NS	0	0	0	25 (0.157)	307 (0.228)	327 (0.413)	549 (0.332)	162 (0.055)	4 (0.006)	0	0	125 (0.108)
1993 - 1994	2 (0.007)	0	0	0	146 (0.064)	571 (0.121)	888 (0.639)	594 (0.485)	97 (0.017)	0	0	0	191.5 (0.111)
1994 - 1995	0	0	0	0	15 (0.009)	1,641 (2.193)	1,716 (1.837)	1,321 (1.511)	279 (0.369)	186 (0.191)	18 (0.022)	1 (0.005)	431.4 (0.511)
1995 - 1996	2 (0.0004)	0	0	0	1,028 (0.437)	2,345 (1.588)	3,854 (2.744)	2,043 (1.908)	282 (0.225)	46 (0.139)	0	1 (0.0002)	800.1 (0.587)
1996 - 1997	0	0	0	0	289 (0.200)	500 (1.624)	711 (0.945)	354 (0.566)	121 (0.076)	9 (0.006)	1 (0.004)	0	165.4 (0.284)
1997 - 1998	0	0	0	0	100 (0.219)	1,649 (1.371)	44 (0.139)	377 (0.457)	161 (0.326)	140 (0.366)	17 (0.018)	2 (0.055)	207.5 (0.246)

Table 2. Lower Sacramento River beach seine **late-fall run** raw catch, catch per cubic meter times 100 (in parenthesis), and maximum monthly statistics for each year for the 1993 through 1998 field seasons. Peak catch per cubic meter values for each brood year per year are highlighted. Average (Aver) catch and CPM³ per month are also shown. NS = no sample.

Field season	Aug	Sep	Oct	Nov	Dec	Jan	Feb	Mar	Apr	May	Jun	Jul	Aver
1992 - 1993	NS	0	1 (0.030)	1 (0.070)	1 (0.090)	1 (0.040)	1 (0.030)	0	2 (0.260)	10 (0.370)	0	0	1.5 (0.081)
1993 - 1994	1 (0.034)	2 (0.021)	29 (0.405)	10 (0.079)	9 (0.128)	1 (0.013)	1 (0.085)	0	0	0	0	0	4.4 (0.064)
1994 - 1995	0	0	0	2 (0.027)	10 (0.438)	7 (0.502)	0	0	0	2 (0.126)	0	0	1.8 (0.091)
1995 - 1996	4 (0.091)	0	0	0	14 (0.403)	2 (0.105)	0	0	0	0	1 (0.038)	0	1.8 (0.053)
1996 - 1997	0	0	0	1 (0.014)	6 (0.545)	0	0	0	0	0	0	0	0.6 (0.047)
1997 - 1998	0	0	0	0	12 (0.825)	1 (0.032)	0	0	0	2 (0.300)	7 (0.769)	0	1.8 (0.161)

Table 3. Lower Sacramento River beach seine **winter run** raw catch, catch per cubic meter times 100 (in parenthesis), and maximum monthly statistics for each year for the 1993 through 1998 field seasons. Peak catch per cubic meter values are highlighted. Average (Aver) catch and CPM³ per month are also shown. NS = no sample.

Field season	Aug	Sep	Oct	Nov	Dec	Jan	Feb	Mar	Apr	May	Jun	Jul	Aver
1992 - 1993	NS	2 (0.110)	0	15 (1.870)	18 (0.650)	52 (2.300)	30 (2.300)	0	0	0	0	0	10.6 (0.657)
1993 - 1994	0	0	2 (0.016)	0	5 (0.052)	7 (0.369)	12 (0.853)	0	0	0	0	0	2.2 (0.108)
1994 - 1995	0	0	0	7 (0.019)	2 (0.064)	53 (1.626)	4 (0.140)	12 (0.157)	0	0	0	0	6.5 (0.167)
1995 - 1996	0	0	0	0	119 (3.046)	45 (1.365)	14 (0.662)	4 (0.305)	1 (0.031)	0	0	0	15.3 (0.451)
1996 - 1997	0	0	0	0	34 (3.515)	0	7 (0.428)	4 (0.255)	0	0	0	0	3.8 (0.350)
1997 - 1998	0	0	0	36 (3.300)	48 (3.710)	48 (3.724)	0	0	0	0	0	0	11.0 (0.895)

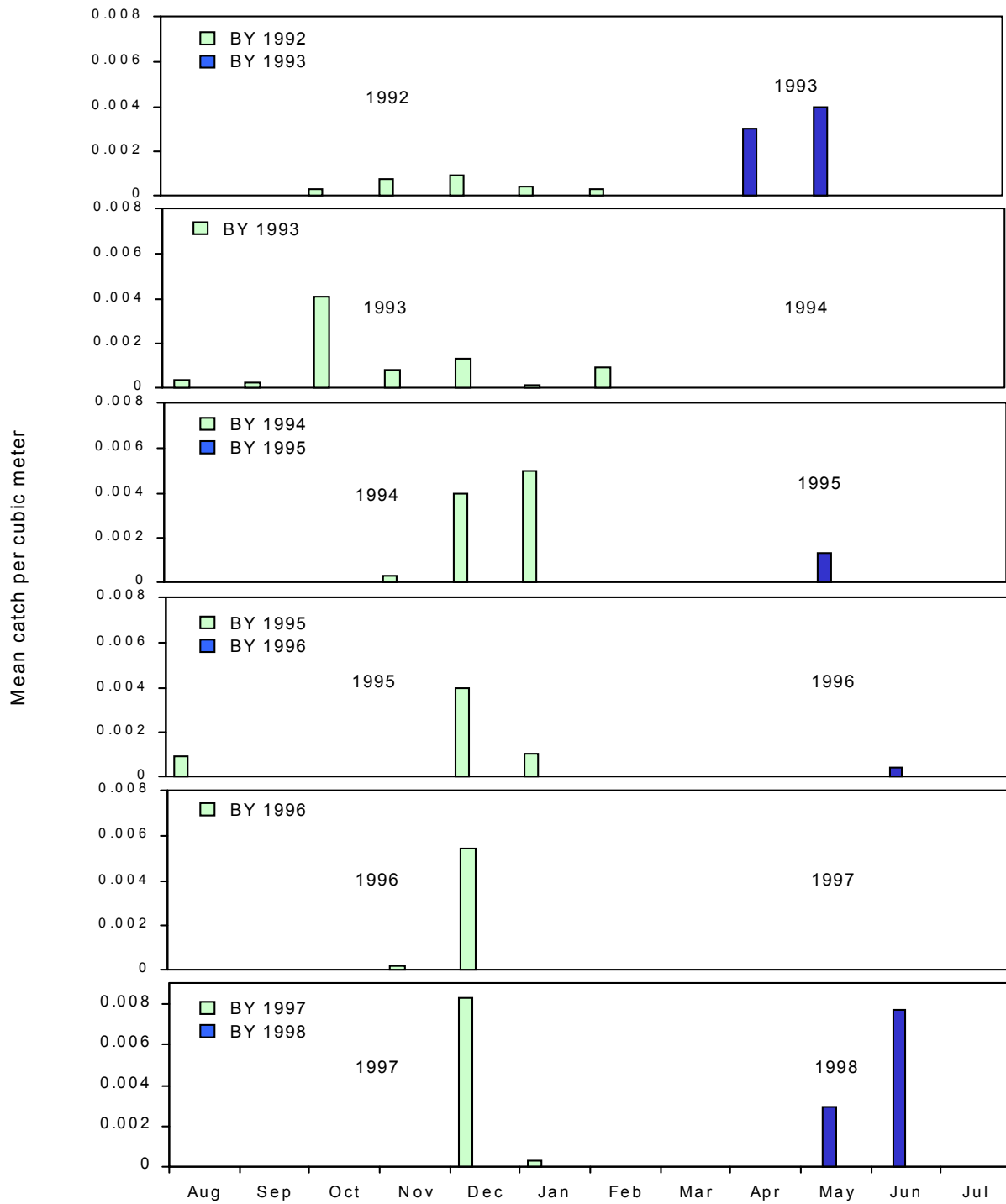

Figure 11. Mean catch per cubic meter of late-fall chinook in the lower Sacramento River beach seine; brood years (BY) 1992, 1993, 1994, 1995, 1996, 1997, 1998.

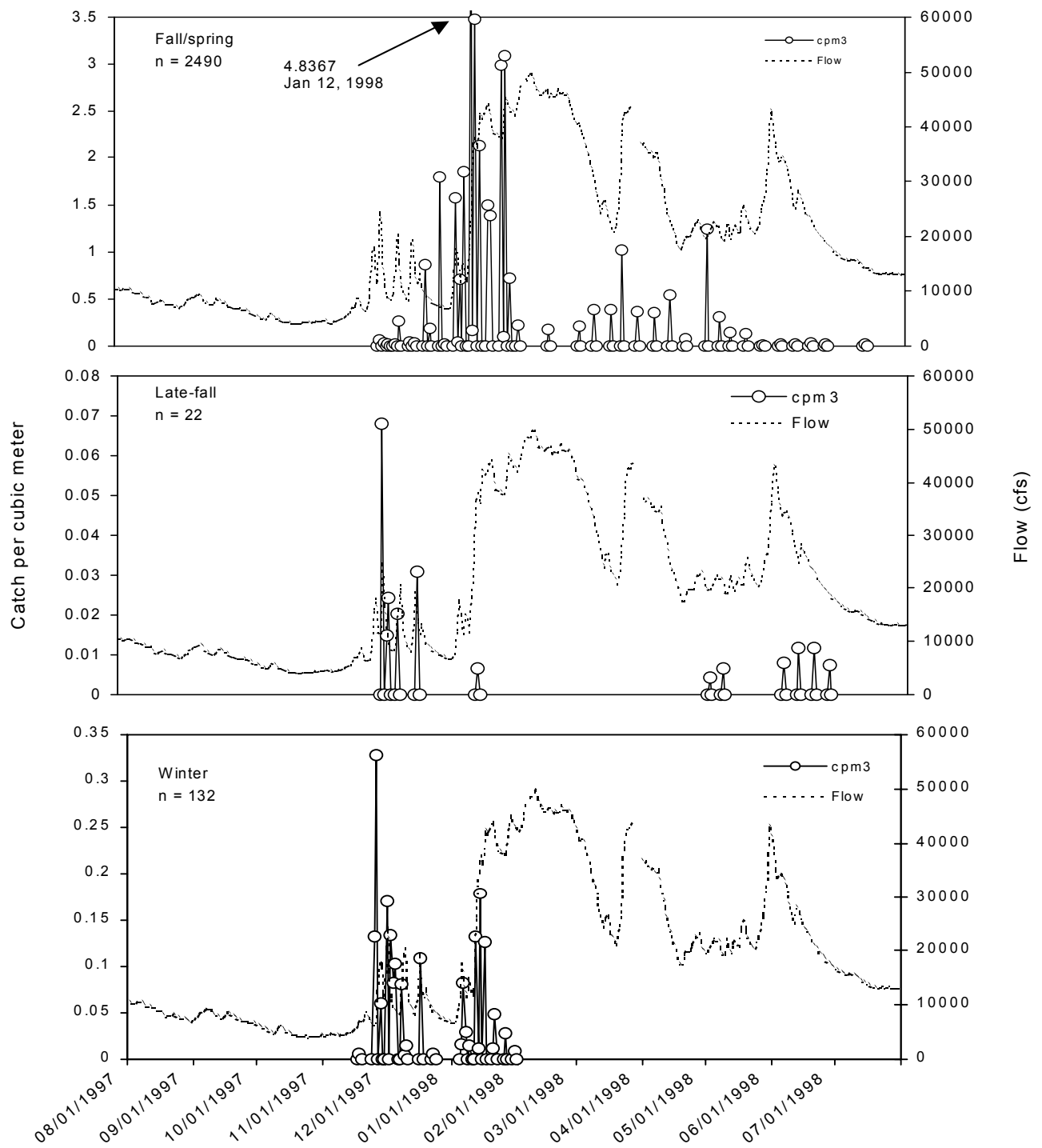

Figure 12. Daily catch per cubic meter in the lower Sacramento River beach seine during the 1998 field season, and flow measured at Colusa (cfs).

Lower San Joaquin River Beach Seine

The lower San Joaquin River beach seine was started in 1994, to document the relative abundance and distribution of San Joaquin River chinook salmon. Seining was conducted once per week, between January and June, each year.

1997 field season

In 1997, sampling was conducted from January 27 through June 24. As a result of flooding, only the furthest downstream site was accessible until March 31 when all of the sites were seined. A total of 44 chinook were captured between March and April. Highest CPM³ (6.594) occurred in March (Figure 13).

1998 field season

In 1998, seining was conducted between January 2 and June 25. Due to high flows, many sites could not be seined.

A total of 256 fall run were captured in 1998, with the highest CPM³ (55.0) occurring in February (Figure 13).

Figure 13 shows the relationship between flows and CPM³ between 1994 and 1998. In 1994 a critically dry water year, 57 chinook were captured in April and May. In 1995, a wet year, 51 chinook were captured between February and June. Although the lowest number of chinook captured was in 1996, a wet year, the lowest CPM³ occurred in 1997. In January 1997, as flows reached flood stages, most of the seine sites were inaccessible, and no chinook were captured until March, during a period of decreasing flows. Chinook were sampled from January through May of 1998, a wet year, when the first large number of chinook were captured just prior to a period of increased flows. While there appeared to be little relationship between flows and juvenile emigration, the 1994 and 1997 juvenile emigration are similar, as are the 1995 and 1998.

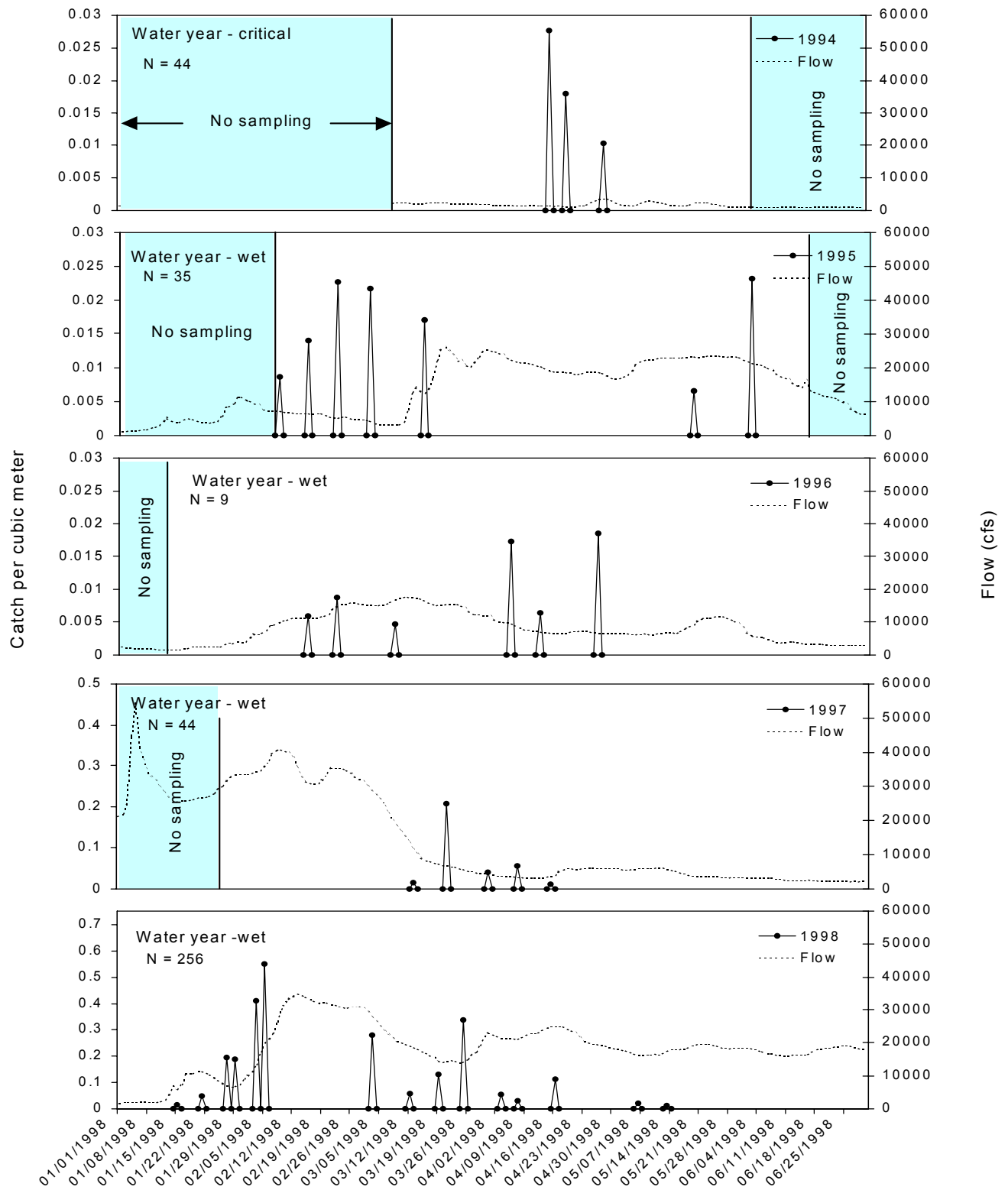

Figure 13. Daily total catch for all races of chinook, and mean daily flow at Vernalis for the San Joaquin seine, 1994 to 1998.

Delta Beach Seine (North, Central, and South Delta)

Delta beach seining was conducted from August 1, 1996, to July 31, 1998. A total of ten North Delta sites were sampled weekly, and ten Central and nine South Delta sites were sampled between two and four times per month (Figures 4 and 5). Between October and April, an additional set of seine sites were sampled five days per week concentrating efforts in the Sacramento area. The additional seine sites consisted of two sites on the lower Sacramento River, three new sites, and three sites in the North Delta. This seining was done in addition to normal sampling to capture winter run juveniles and spring run yearlings as they enter the Delta.

1997 Field Season

Fry fall/spring run catches began at the onset of the first significant flow event of the season in December and continued through February. Smolts began dominating the catches in March and trailed off towards the end of June. The maximum CPM³ = 0.474 was in February, the lowest observed since 1993 (Figure 14 and Table 4).

Catches of late-fall juveniles during the 1997 field season occurred between November 26, 1996, and May 13, 1997. While peak catches occurred during January, they were too low to determine temporal timing. A total of six yearlings from the 1996 brood year were captured and two from the 1997 brood year were captured (fry). Catches of late-fall fry during the spring weren't as low since 1994, a critically dry water year (Figure 14 and Table 5).

Winter run catches during 1997 appeared to occur at the beginning of flow events or directly following them. Catches were very low in the Delta, occurring between November and March. Similar to late-fall fry catches, catches of winter run were the lowest observed since 1994 (Figure 14 and Table 6).

1998 Field Season

Fall/spring run catches were dominated by fry between December and March and smolts between April and June. A total of 6,586 fall/spring run were captured between August 12, 1997, and June 23, 1998. In contrast with the 1997 field season, catches were much more prolific particularly during the spring (Figure 15 and Tables 4).

Late-fall 1997 brood year catches during the winter were very low, however, 1998 brood year fry catches in the spring were the highest on record since 1993. Catches for the 1998 field season occurred between November 28, 1997, and June 23, 1998 (Figure 15 and Tables 5).

A total of 58 winter run were captured in the Delta between November 28, 1997, and March 25, 1998. Highest densities were observed in December, and 1998 monthly CPM³ was the highest of the last six years. As in past years, catches were observed directly after or during significant flow events (Figure 15 and Table 6).

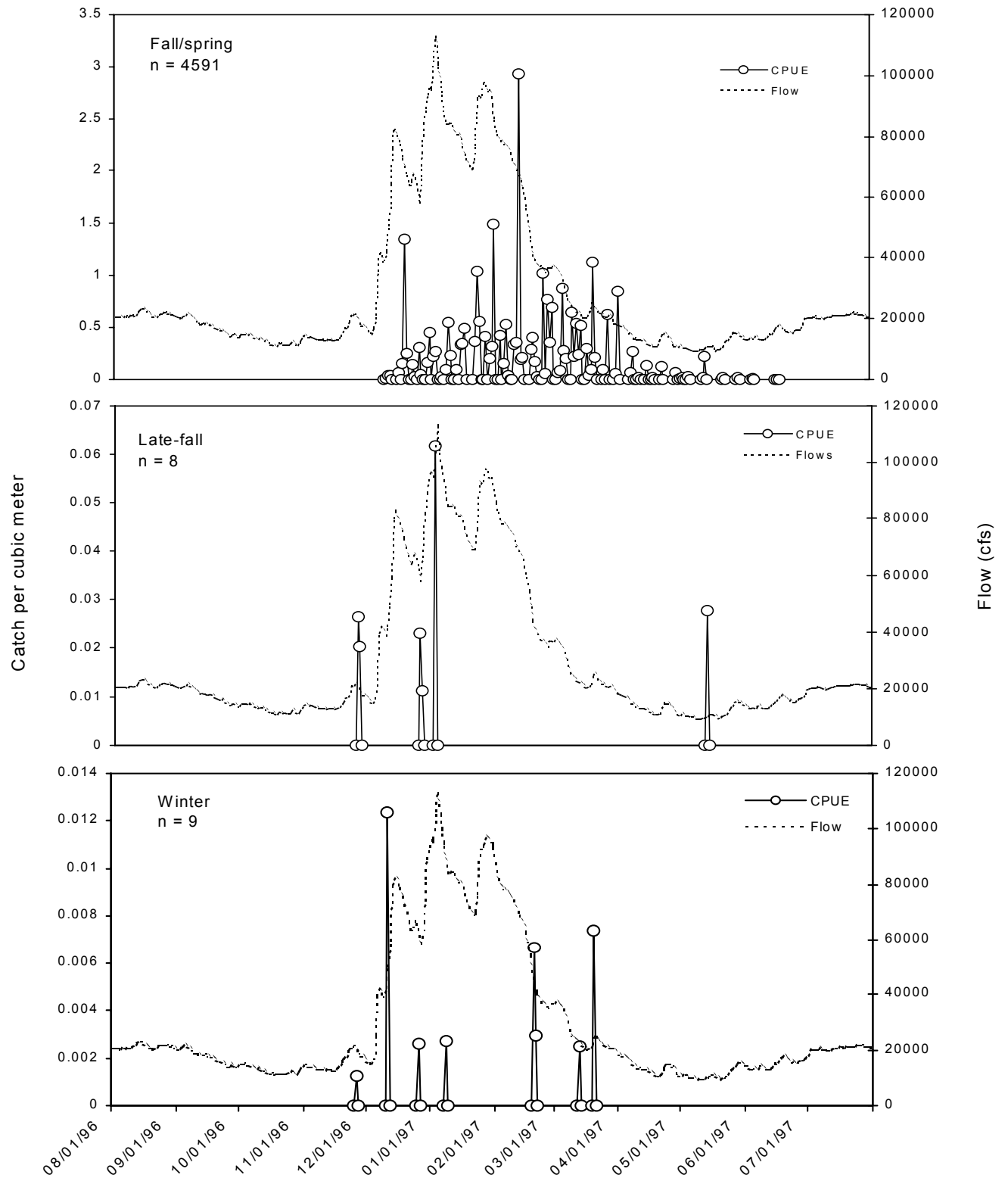

Figure 14. Daily catch per cubic meter (CPM³) in the Delta area beach seine during the 1997 field season, and flow on the Sacramento River at Freeport.

Table 4. Delta beach seine **fall/spring run** raw catch, catch per cubic meter times 100 (in parenthesis), and maximum monthly statistics for each year for the 1993 through 1998 field seasons. Peak catch per cubic meter values are highlighted. Average (Aver) catch and CPM³ per month are also shown. NS = no sample.

Field season	Aug	Sep	Oct	Nov	Dec	Jan	Feb	Mar	Apr	May	Jun	Jul	Aver
1992 - 1993	NS	0	0	0	11 (0.005)	156 (0.131)	283 (0.146)	756 (0.571)	1,048 (0.286)	98 (0.044)	17 (0.015)	NS	236.9 (0.120)
1993 - 1994	0	0	0	2 (0.0006)	12 (0.003)	119 (0.036)	1,943 (0.493)	582 (0.117)	115 (0.048)	24 (0.008)	3 (0.0001)	0	233.3 (0.059)
1994 - 1995	0	1 (0.0003)	0	0	16 (0.004)	3,357 (0.679)	3,394 (0.842)	4,716 (1.204)	1,132 (0.233)	265 (0.046)	27 (0.005)	1 (0.0002)	1075.8 (0.251)
1995 - 1996	0	0	0	0	1,261 (0.133)	3,159 (0.448)	7,927 (1.669)	4,724 (0.834)	720 (0.135)	106 (0.022)	6 (0.001)	4 (0.002)	1492.3 (0.270)
1996 - 1997	0	0	0	0	725 (0.182)	829 (0.409)	1,341 (0.474)	1,159 (0.299)	500 (0.110)	34 (0.019)	3 (0.0006)	0	382.6 (0.125)
1997 - 1998	1 (0.0002)	0	0	0	56 (0.016)	1,490 (0.481)	1,419 (0.419)	2,232 (0.595)	1,062 (0.247)	278 (0.069)	48 (0.008)	0	548.8 (0.153)

Table 5. Delta beach seine **late-fall run** raw catch, catch per cubic meter x's 100 (in parenthesis), and maximum monthly statistics for each year between 1993 and 1998 field seasons. Peak catch per cubic meter values for each brood year are highlighted. Average (Aver) catch and CPM³ per month are also shown. NS = no sample.

Field season	Aug	Sep	Oct	Nov	Dec	Jan	Feb	Mar	Apr	May	Jun	Jul	Aver
1992 - 1993	NS	0	0	2 (0.0008)	1 (0.0004)	1 (0.0008)	0	0	0	0	6 (0.003)	NS	1.0 (0.0005)
1993 - 1994	NS	0	0	0	3 (0.0006)	3 (0.0007)	0	0	0	0	0	0	0.5 (0.0001)
1994 - 1995	0	0	0	1 (0.0001)	9 (0.0007)	4 (0.002)	1 (0.0001)	0	1 (0.0004)	3 (0.0005)	0	0	1.6 (0.0003)
1995 - 1996	0	0	0	0	6 (0.0009)	2 (0.0003)	2 (0.001)	0	1 (0.0002)	7 (0.0006)	0	1 (0.0003)	1.6 (0.0003)
1996 - 1997	0	0	0	3 (0.0002)	2 (0.0004)	1 (0.002)	0	0	1 (0.0002)	1 (0.001)	0	0	0.7 (0.0003)
1997 - 1998	0	0	0	1 (0.0002)	7 (0.003)	0	0	0	18 (0.006)	4 (0.001)	10 (0.0006)	0	3.3 (0.0009)

Table 6. Delta beach seine **winter run** raw catch, catch per cubic meter x's 100 (in parenthesis), and maximum monthly statistics for each year between 1993 and 1998 field seasons. Peak catch per cubic meter values are highlighted. Average (Aver) catch and CPM³ per month are also shown. NS = no sample.

Field season	Aug	Sep	Oct	Nov	Dec	Jan	Feb	Mar	Apr	May	Jun	Jul	Aver
1992 - 1993	NS	0	0	9 (0.003)	4 (0.001)	7 (0.006)	7 (0.003)	1 (0.0007)	0	0	0	NS	2.8 (0.0014)
1993 - 1994	NS	0	0	0	0	0	2 (0.001)	0	0	0	0	0	0.2 (0.0001)
1994 - 1995	0	0	0	0	0	6 (0.003)	4 (0.002)	1 (0.0002)	0	0	0	0	0.9 (0.0004)
1995 - 1996	0	0	0	0	73 (0.011)	39 (0.006)	20 (0.007)	5 (0.001)	2 (0.001)	0	0	0	11.6 (0.002)
1996 - 1997	0	0	0	1 (0.0005)	2 (0.0007)	1 (0.001)	2 (0.0006)	3 (0.0004)	0	0	0	0	0.8 (0.0003)
1997 - 1998	0	0	0	5 (0.004)	42 (0.012)	9 (0.002)	1 (0.0005)	1 (0.0004)	0	0	0	0	4.8 (0.0016)

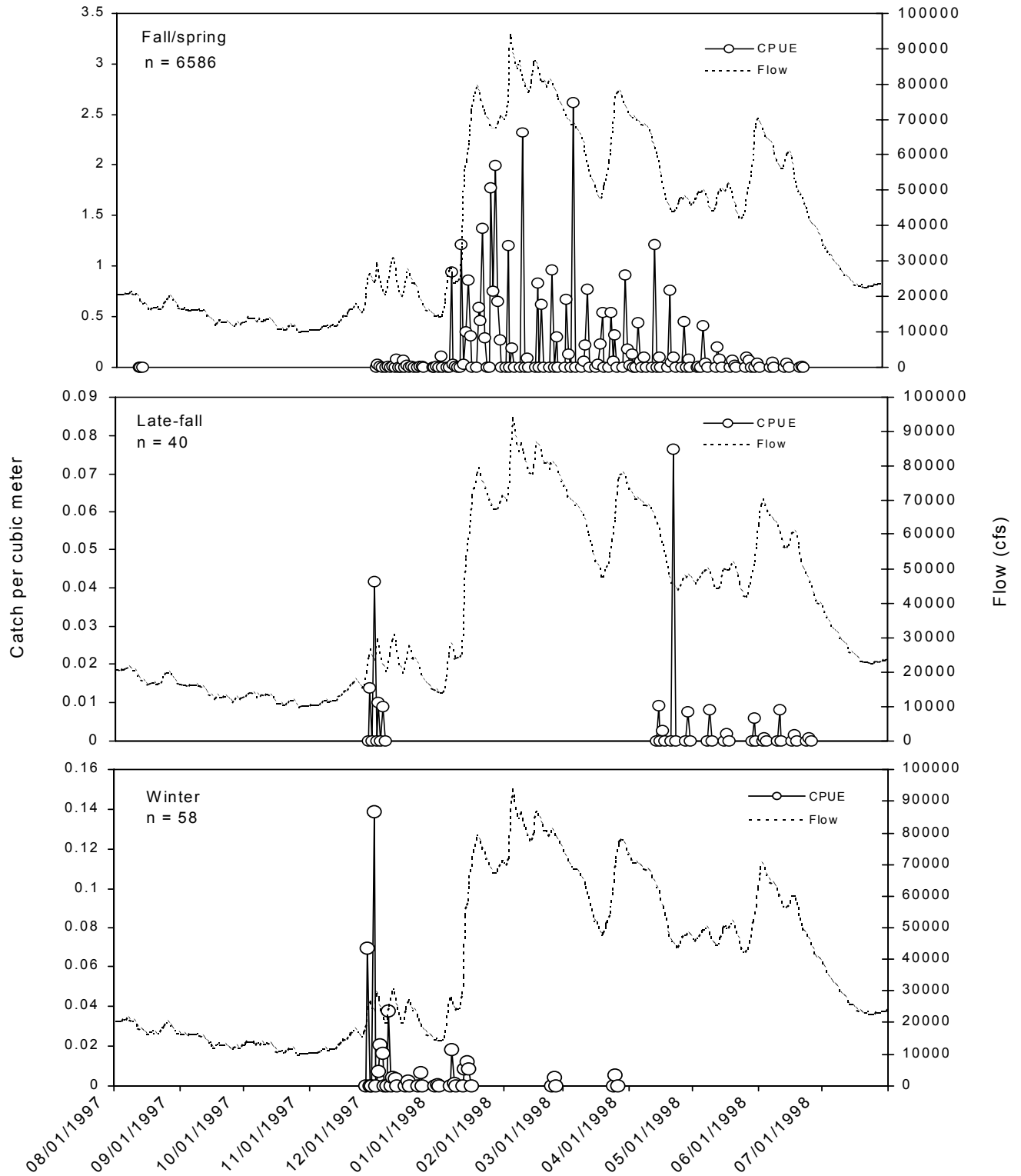

Figure 15. Daily catch per cubic meter (CPM³) in the Delta area beach seine during the 1998 field season, and flow on the Sacramento River at Freeport.

Kodiak and Midwater Trawl at Sacramento

Beginning in 1995 and continuing to the present, two types of gears have been used for trawling near Sacramento, the Kodiak and midwater trawl. Kodiak trawling has normally occurred from mid-October through March, and midwater trawling from April through September. The larger Kodiak trawl targeted the scarcer and larger races of chinook (late-fall and winter run), while the midwater trawl was used for fry abundance and historical documentation for consistency. All trawling was done approximately 6.4 kilometers (four miles) downstream of Sacramento to estimate the relative abundance and timing of juvenile salmon entering the Delta. The same site has been sampled since 1988, except 1990, when sampling was done near the town of Courtland approximately 34 kilometers (21 miles) downstream of the present site. As in the past, 10 twenty minute tows were conducted between three and seven days a week depending on the need to index the relative abundance of juvenile salmon entering the Delta.

The Kodiak and midwater trawls have been used interchangeably between January and March when high flows occur. During these high flow periods when large debris fields were moving down the river, Kodiak trawling became hazardous. Changing over to the midwater trawl allowed sampling to continue.

1997 field season

In January, sampling was curtailed for 21 days due to flows that were near flood stage. Daily catch per cubic meter and the associated flows are shown in Figures 16.

Most fall/spring were captured between April and May using the midwater trawl. These fish were captured well after peak flows, and during a period of hatchery releases (Figure 16 and Table 7).

A total of 959 fall/spring were captured by the Kodiak trawl, while the midwater trawl captured 7,532 fall/spring. The Kodiak trawl numbers were low due to the high flows during the winter months and the suspension of trawling for safety reasons.

Catches of late-fall run chinook were highest in November and December ($n = 16$), and coincided with increasing flows. Four late-fall were captured between January and February. Only 1996 brood year chinook were captured, and their size range was 98 - 221 mm. The midwater trawl captured two late-fall on January 30 and 31, 1997, (165 - 218 mm) during one of the periods when Kodiak trawling was suspended (Figure 16 and Table 8).

Winter run catches occurred during a period of increasing flows, and again as the flows were receding, however sampling was suspended for 21 days during high flows. Winter run fry ranged in size from 52 mm on December 16, 1996, to 142 mm on March 3, 1996. Of the 44 winter run captured, only four were captured by the midwater trawl (Figure 16 and Table 9).

1998 field season

Between January 2, 1998, and February 23, 1998, 10 of 25 sampling days were not conducted due to high flows. Daily catch per cubic meter and the associated flows are shown in Figure 17.

In January, at the beginning of high flows, a large group of fall/spring run chinook were captured. There was a second period of increased catches from the end of April through June, which may likely have been the result of hatchery releases from Coleman National Fish Hatchery. Unlike 1997, when Kodiak trawling was periodically suspended during the winter months, in 1998, Kodiak trawling was conducted throughout the scheduled period (excluding the above period when no sampling was conducted). The Kodiak trawl captured 6,040 fall/spring, nearly twice as many of this race as the midwater trawl ($n = 3,499$) (Figure 17 and Table 7).

Brood year 1997 late-fall run catches began August 4, 1996, and continued through December 1996 with

a fork length range of 68 - 127 mm. A relatively large group was captured as flows increased during December. Two brood year 1998 late-fall were captured in the midwater trawl (April 27, 1998, at 36 mm, and June 15, 1998, at 51 mm) (Figure 17 and Table 8).

Catches of winter run chinook during 1998 were similar to 1997 catches. Peak catches occurred during increasing flows (fork lengths 52-96 mm), and again during high flows (fork lengths 92-145 mm). A high catch per cubic meter occurred during a short period of decreasing flows in March. The majority of the winter run were captured by the Kodiak trawl, which was operated during the peak emigration period (n = 57 for the Kodiak trawl, and n = 5 for the midwater trawl) (Figure 17 and Table 9).

Figure 18 shows midwater trawl mean catch per cubic meter between 1988 and 1998 for April, May, and June. Although catches have continued to decline, the reason may be that the fry move out earlier during wet years such as the period from 1995 through 1998.

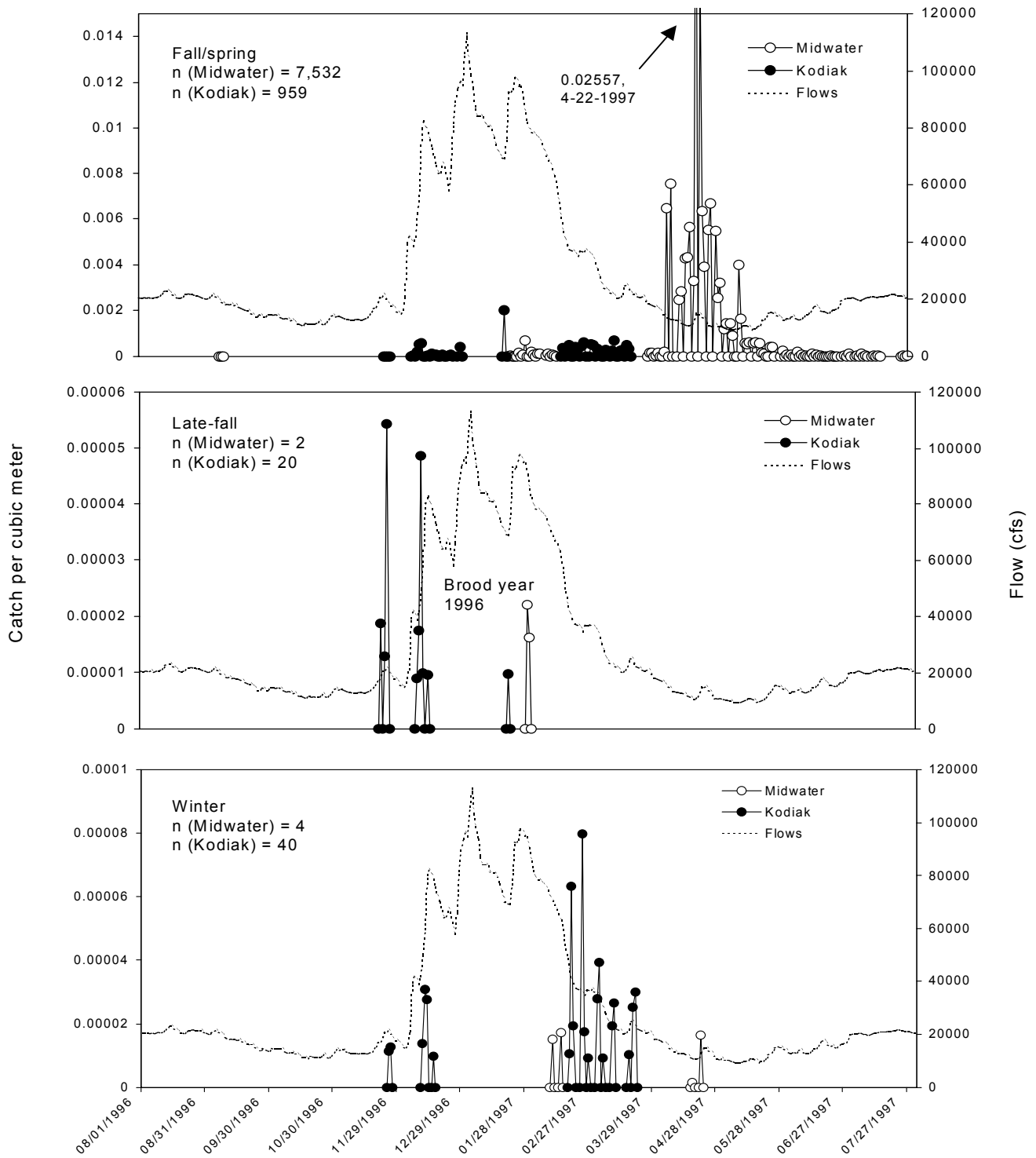

Figure 16. Daily catch per cubic meter in the midwater and Kodiak trawl at Sacramento during the 1997 field season for fall/spring, late-fall, and winter run chinook salmon, and flow on the Sacramento River at Freeport (cfs).

Table 7. Sacramento River midwater and Kodiak trawling **fall/spring** run raw catch, catch per cubic meter X's 10,000 (in parenthesis), and average (Aver) catch and CPM³ per year for the 1994 through 1998 field seasons. Peak catch per unit effort values are highlighted. NS = Not sampled.

Field season	Aug	Sep	Oct	Nov	Dec	Jan	Feb	Mar	Apr	May	Jun	Jul	Aver
1993 - 1994 m wtr	NS	1 (0.042)	0	1 (0.007)	4 (0.075)	192 (1.994)	1,036 (10.95)	69 (0.850)	6,588 (109.4)	2,425 (27.45)	73 (1.648)	NS	1,038.9 (15.24)
1994 - 1995 m wtr	NS	0	0	0	6 (0.069)	NS	NS	1,020 (23.03)	648 (14.78)	2,312 (13.88)	289 (4.382)	20 (0.261)	477.2 (6.267)
1994 - 1995 kdtr	NS	NS	NS	NS	0	1,132 (18.88)	1,168 (7.581)	2,324 (58.79)	1,366 (9.675)	NS	NS	NS	1,198 (18.99)
1995 - 1996 m wtr	6 (0.073)	0	0	NS	NS	NS	NS	NS	5,767 (44.18)	5,493 (31.52)	62 (2.344)	13 (0.229)	1,620.1 (11.19)
1995 - 1996 kdtr	NS	NS	0	0	669 (2.529)	7,456 (35.26)	21,044 (122.6)	2,802 (168.2)	2,111 (512.4)	NS	NS	NS	6,816.4 (168.2)
1996 - 1997 m wtr	0	1 (0.013)	0	NS	NS	46 (1.726)	47 (0.935)	9 (1.674)	5,886 (51.84)	1,451 (13.56)	59 (0.881)	30 (0.576)	752.9 (7.121)
1996 - 1997 kdtr	NS	NS	0	2 (0.014)	191 (1.599)	117 (20.36)	242 (4.18)	407 (2.711)	NS	NS	NS	NS	159.8 (4.811)
1997 - 1998 m wtr	10 (0.161)	1 (0.019)	0	NS	NS	NS	NS	22 (7.347)	1,734 (25.49)	1,061 (15.53)	671 (7.78)	NS	499.9 (8.047)
1997 - 1998 kdtr	NS	NS	0	2 (0.012)	37 (0.274)	3,211 (89.64)	1,530 (53.79)	1,260 (12.73)	NS	NS	NS	NS	1,006.7 (26.09)

Table 8. Sacramento River midwater and Kodiak trawl **late-fall run** raw catch, catch per cubic meter X's 10,000 (in parenthesis), and average (Aver) catch and CPM³ per year for the 1994 through 1998 field seasons. Peak catch per cubic meter values are highlighted. NS = Not sampled. * = partial effort during December and January.

Field season	Aug	Sep	Oct	Nov	Dec	Jan	Feb	Mar	Apr	May	Jun	Jul	Aver
1993 - 1994 m wtr	NS	4 (0.155)	19 (0.207)	1 (0.0049)	4 (0.0476)	1 (0.0104)	2 (0.0197)	0	0	0	0	NS	3.1 (0.0445)
1994 - 1995 m wtr*	NS	0	0	1 (0.011)	30 (0.332)	NS	NS	0	0	0	0	1 (0.016)	3.6 (0.0399)
1994 - 1995 kdtr*	NS	NS	NS	NS	2 (0.048)	8 (0.153)	0	0	0	NS	NS	NS	2.0 (0.0402)
1995 - 1996 m wtr	1 (0.0159)	1 (0.0125)	0	NS	NS	NS	NS	NS	1 (0.0057)	0	0	0	0.43 (0.0049)
1995 - 1996 kdtr	NS	NS	0	0	17 (0.0704)	10 (0.0427)	0	0	0	NS	NS	NS	3.9 (0.0162)
1996 - 1997 m wtr	0	0	0	NS	NS	2 (0.0639)	0	0	0	0	0	0	0.2 (0.0064)
1996 - 1997 kdtr	NS	NS	0	8 (0.0453)	8 (0.0388)	1 (0.150)	1 (0.0162)	0	NS	NS	NS	NS	3.0 (0.0417)
1997 - 1998 m wtr	5 (0.0901)	3 (0.0689)	2 (0.0783)	NS	NS	NS	NS	0	1 (0.0193)	0	1 (0.0122)	NS	1.7 (0.0384)
1997 - 1998 kdtr	NS	NS	0	16 (0.096)	5 (0.0441)	0	0	0	NS	NS	NS	NS	3.5 (0.0234)

Table 9. Sacramento River midwater and Kodiak trawl **winter run** raw catch, catch per cubic meter x's 10,000 (in parenthesis), and average (Aver) catch and CPM³ per year for the 1994 through 1998 field seasons. Peak catch per cubic meter values are highlighted. NS = Not sampled.

Field season	Aug	Sep	Oct	Nov	Dec	Jan	Feb	Mar	Apr	May	Jun	Jul	Aver
1993 - 1994 mwr	NS	0	0	0	0	0	8 (0.0839)	2 (0.0235)	5 (0.0536)	0	0	NS	1.5 (0.0161)
1994 - 1995 mwr	NS	0	0	0	0	NS	NS	15 (0.334)	10 (0.281)	0	0	0	1.4 (0.0559)
1994 - 1995 kdtr	NS	NS	NS	NS	1 (0.026)	3 (0.054)	40 (0.292)	35 (0.892)	46 (0.356)	NS	NS	NS	25.0 (0.324)
1995 - 1996 mwr	0	0	0	NS	NS	NS	NS	NS	2 (0.0113)	0	0	0	0.3 (0.0016)
1995 - 1996 kdtr	NS	NS	0	0	61 (0.249)	31 (0.142)	31 (0.170)	120 (0.723)	3 (0.605)	NS	NS	NS	35.1 (0.2699)
1996 - 1997 mwr	0	0	0	NS	NS	0	2 (0.0407)	0	2 (0.0130)	0	0	0	0.4 (0.0077)
1996 - 1997 kdtr	NS	NS	0	2 (0.0161)	8 (0.0338)	0	13 (0.213)	18 (0.117)	NS	NS	NS	NS	6.8 (0.0633)
1997 - 1998 mwr	0	0	0	NS	NS	NS	NS	0	5 (0.0820)	0	0	NS	0.7 (0.0117)
1997 - 1998 kdtr	NS	NS	0	10 (0.0763)	9 (0.0882)	2 (0.0151)	3 (0.0694)	33 (0.233)	NS	NS	NS	NS	9.3 (0.0803)

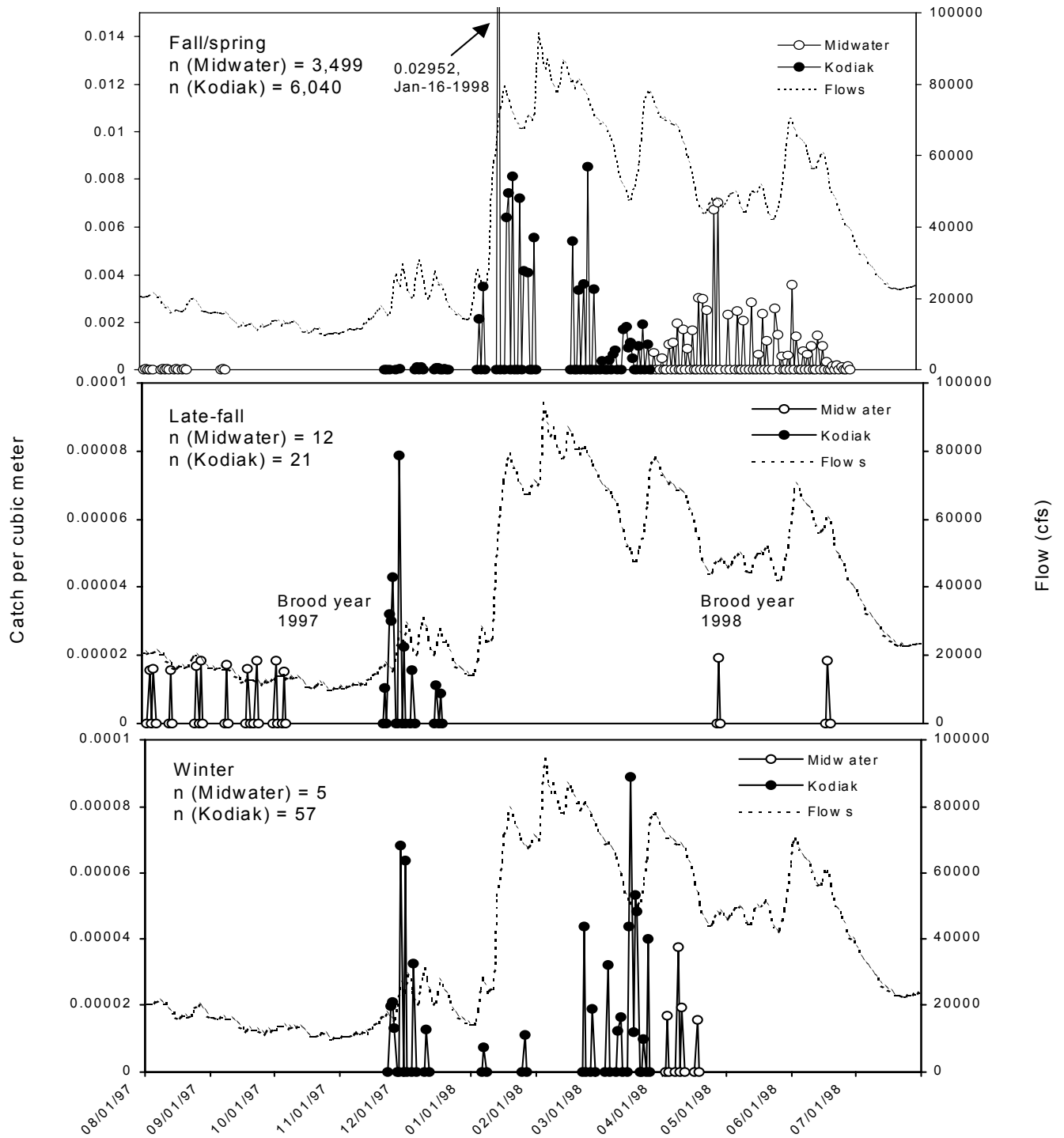

Figure 17. Daily catch per cubic meter in the midwater and Kodiak trawl at Sacramento during the 1998 field season for fall/spring, late-fall, and winter run chinook salmon, and flow on the Sacramento River at Freeport (cfs).

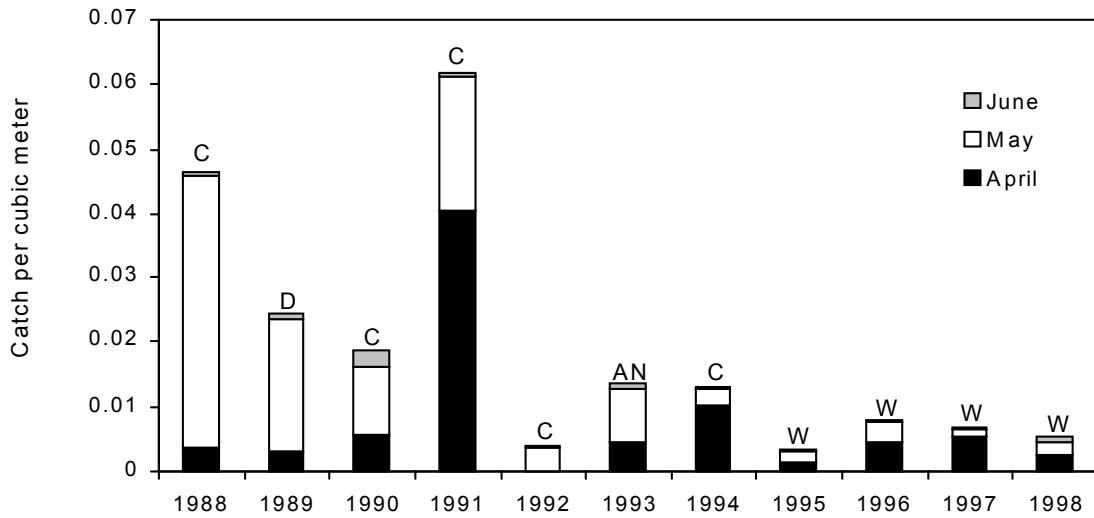

Figure 18. Mean catch per cubic meter of salmon smolts per 20 minute tow with Sacramento midwater trawl in April, May, and June from 1988 to 1998. There was no sampling in April of 1992. W = wet year, AN = above normal year, D = dry year, and C = critical year.

Kodiak Trawl at Mossdale

Trawling at Mossdale began on September 4, 1996, to index juvenile salmon moving into the Delta from the San Joaquin basin.

All San Joaquin River chinook have been classified as fall run because it is presently the only recognized race in the San Joaquin tributaries. Spring run chinook were eliminated from the three San Joaquin River tributaries (Stanislaus, Tuolumne, and Merced) by 1930 and from the mainstem by 1947 as a result of dam construction (USFWS, May 9, 1995).

1997 field season

The sampling season was from September 1996 to July 1997, however sampling was suspended between December 31, 1996, and March 20, 1997, due to flows that reached flood stage, and mechanical problems. When trawling resumed on March 21, 1997, juvenile chinook were captured, and continued to be captured until the end of the season. A total of 1,596 chinook were captured from April through June (Figure 18).

1998 field season

The 1998 sampling season did not begin until April 3 due to a lack of available boats during the fall months, and then high flows starting in January. Juvenile chinook were captured when sampling began in April. A total of 2,316 juvenile chinook were captured from April through June. Highest catch per cubic meter occurred on May 5. There were two fry chinook captured on June 2 at 46 and 47 mm while all other chinook, ranged in size from 82 mm to 108 mm (Figure 19).

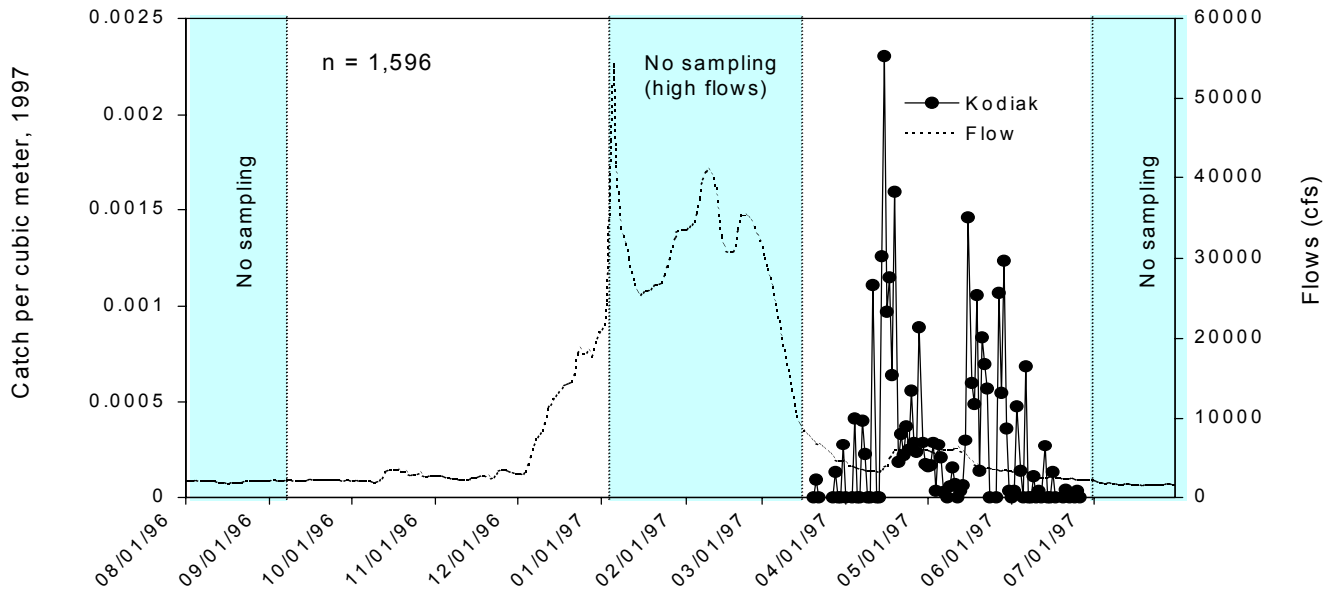

Figure 18. Daily catch per cubic meter of fall run chinook salmon in the Kodiak trawl at Mossdale during the 1997 field season. Flow information was taken at Vernalis.

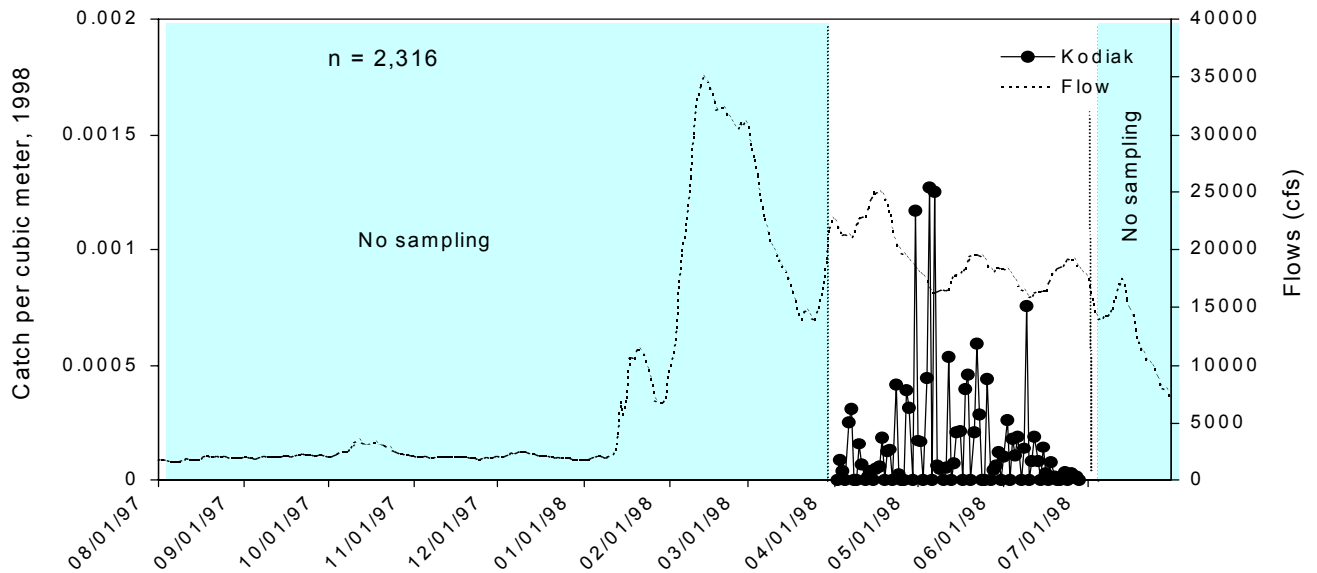

Figure 19. Daily catch per cubic meter of fall run chinook salmon in the Kodiak trawl at Mossdale during the 1998 field season, and flow on the San Joaquin River at Vernalis.

Midwater Trawling at Chipps Island

Trawling at Chipps Island was conducted to document baseline fall/spring, winter, and late-fall run abundance trends, and to recover marked salmon from survival studies. Ten 20 minute tows were conducted between three and seven days a week depending on the need to recover coded wire tagged salmon for survival studies.

1997 field season

Fall/spring catches for 1997 were relatively low with only 3,957 chinook captured. Although abundance was highest during April and May, a period when hatchery released chinook have historically made up a large portion of the catch, the numbers were the lowest for the five years shown in Table 10. A reason for the overall low abundance in 1997 might have been the large storm event in January, which melted much of the snow pack, bringing the rivers to flood stage. From January 4 through January 12, trawling was suspended due to a moratorium on boating in the Delta. During this period many of the fish may have been pushed out of the system (Figure 20).

A total of 86 late-fall were captured in 1997. Brood year 1996 catches occurred from December 3, 1996, through January 30, 1997, and size ranges were 99 - 231 mm. Peak catches occurred on January 16, 1997. No brood year 1997 fry were captured between April and July, a period when young-of-the-year emigrate (Figure 20 and Table 11).

Winter run chinook catches for 1997 totaled 163. Catches were from December through May, with the peak occurring on March 21, 1997 (Figure 20 and Table 12). Sizes ranged from 84 mm to 141 mm.

1998 field season

A total of 33,947 fall/spring were captured in 1998 at Chipps Island. One reason for the high raw catches in 1998 was a doubling of effort during the spring. During this period of sampling, 20 twenty minute tows were conducted per day, 10 in the morning and 10 in the late afternoon, seven days per week, from April 16 through May 30 to increase recovery of CWT smolts (Figure 21 and Table 10). Even during months outside the period of double effort, CPM³ was generally higher in 1998 than 1997, and catches in 1997 were higher only during November and December (Table 10).

Late-fall catches and peak CPM³ were slightly higher in 1997 than in 1998 (n = 83). Sizes ranged between 73 and 193 mm, and peak catches occurred on December 3, 1997. Like 1997, no young-of-the-year fish were captured in 1998 (Figure 21 and Table 11).

There were 112 winter run chinook captured between December and May. Peak catches occurred on March 18, 1998 (Figure 21 and Table 12). Sizes ranged from 80 mm to 146 mm.

During the five year period shown in Table 10, 11, and 12, peak CPM³ for fall/spring occurred in April or May, for late-fall in December, and for winter run in March. Average CPM³ in 1997 was the lowest for fall/spring and late-fall, while 1998 was the second highest for both races. Winter run average CPM³ was the third and fourth lowest for 1997 and 1998 respectively.

As in past years, most of the smolts in 1997 and 1998 migrated through the Delta in April and May, reflecting the high numbers of fall/spring run chinook, and the influence of hatchery releases from Coleman National Fish Hatchery. The mean juvenile chinook abundance in 1997 for April, May, and June was the lowest on record at 5.9. Only one other year since 1978 has had a mean abundance lower than 10.0; that year was 1994 (7.8). The mean abundance of juvenile chinook for 1998 was 24.3, which was above the 20 year average of 19.3. Starting with 1978, catches every third year have been higher

than the previous two years, with the exception of 1980. For a 10 year period beginning in 1989, there has been one year of low catches for every two years of higher catches. It is interesting that while average catches per year were 27.4 for 1978 through 1983, during the successive 10 years, the yearly average catch was 17.1 between 1988 and 1998 (Figure 22).

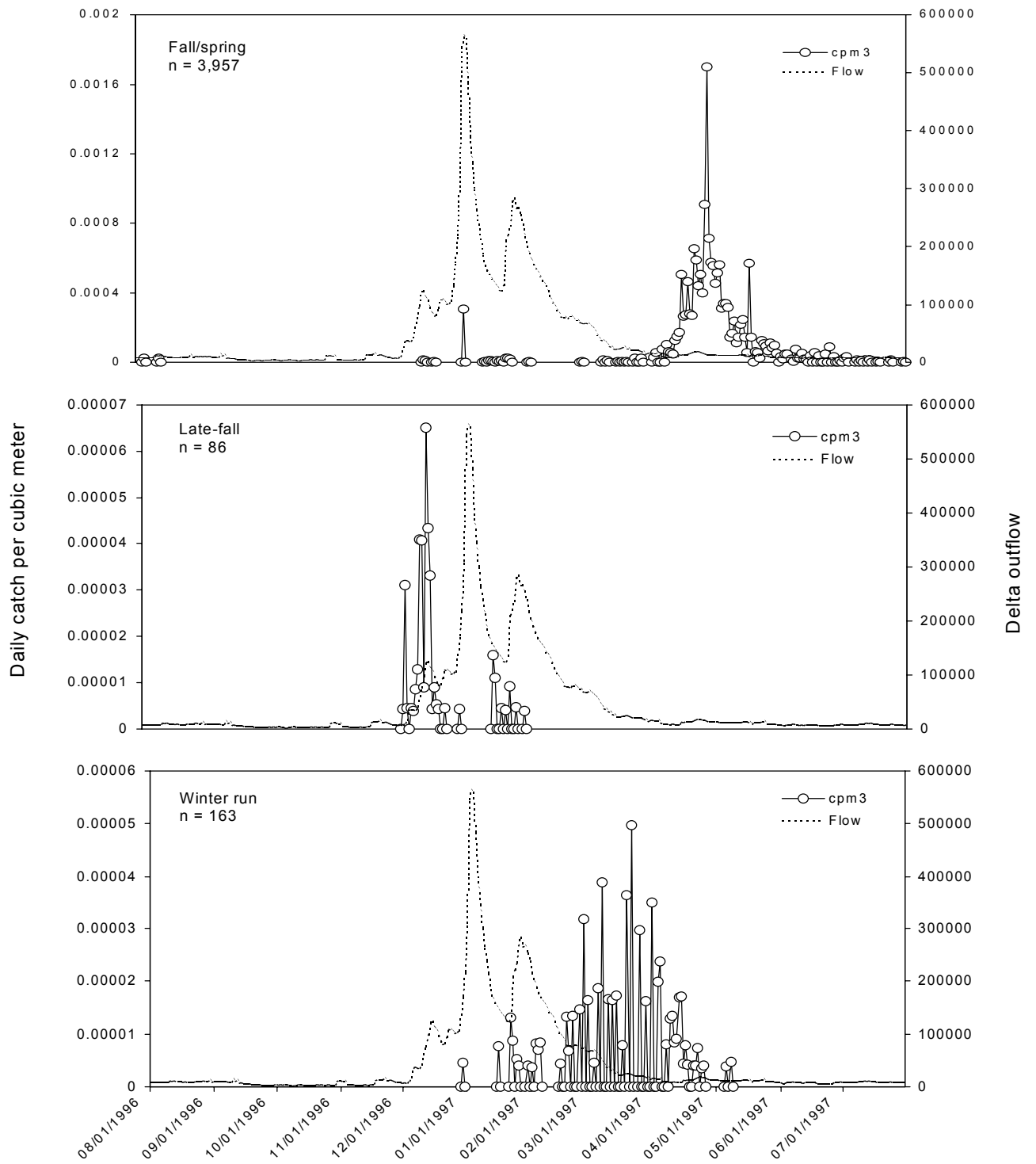

Figure 20. Daily catch per cubic meter in the Chipps Island midwater trawl during the 1997 field season for fall/spring, late-fall, and winter run chinook salmon.

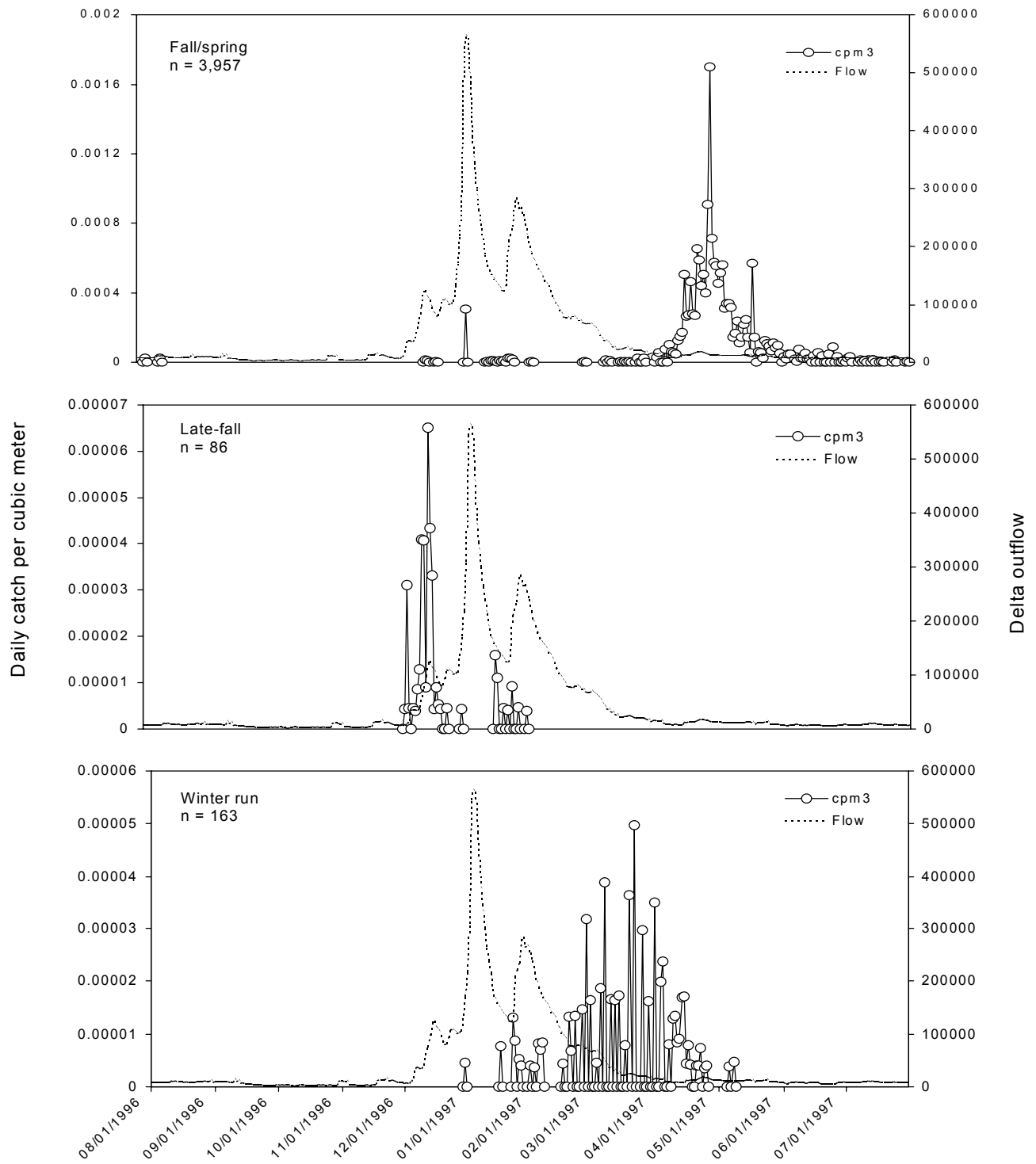

Figure 20. Daily catch per cubic meter in the Chipps Island midwater trawl during the 1997 field season for fall/spring, late-fall, and winter run chinook salmon.

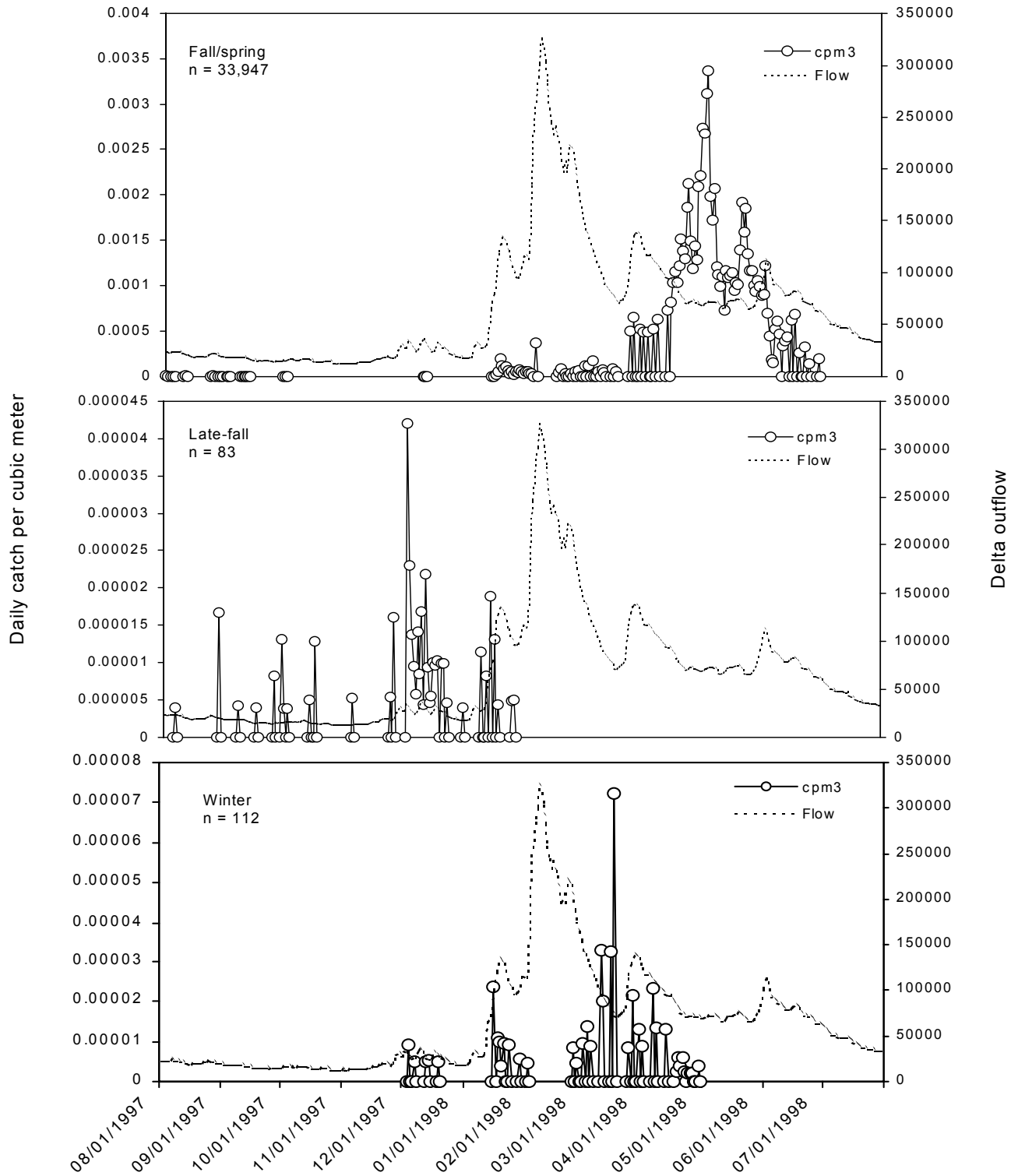

Figure 21. Daily catch per cubic meter in the Chippis Island midwater trawl during the 1998 field season for fall/spring, late-fall, and winter run chinook salmon. Delta outflow information was not available for May 5, 1998, through May 28, 1998.

Table 10. Chipps Island midwater trawl **fall/spring run** raw catch, catch per cubic meter X's 10,000 (in parenthesis), and average (Aver) catch and CPM³ per year for the 1994 through 1998 field seasons. Peak catch per unit effort values are highlighted. NS = Not sampled.

Field season	Aug	Sep	Oct	Nov	Dec	Jan	Feb	Mar	Apr	May	Jun	Jul	Aver
1993 - 1994	NS	NS	NS	11 (0.331)	0	0	1 (0.003)	5 (0.017)	3,713 (4.439)	2,094 (3.740)	102 (0.195)	NS	740.8 (4.293)
1994 - 1995	NS	NS	15 (0.057)	9 (0.036)	0	457 (0.572)	125 (0.407)	262 (1.134)	4,179 (7.779)	11,423 (15.39)	3,178 (0.511)	100 (0.345)	1,975 (2.623)
1995 - 1996	14 (0.03)	8 (0.068)	15 (0.193)	1 (0.013)	2 (0.031)	59 (0.100)	1,578 (3.661)	688 (1.590)	4,233 (9.356)	10,195 (13.58)	339 (1.508)	0	1,427.7 (2.511)
1996 - 1997	2 (0.141)	NS	0	1 (0.011)	7 (0.017)	31 (0.817)	2 (0.004)	27 (0.123)	2,351 (3.912)	1,323 (2.358)	187 (0.358)	26 (0.103)	359.6 (0.713)
1997 - 1998	10 (0.047)	3 (0.013)	1 (0.003)	0	1 (0.002)	209 (0.336)	138 (0.678)	568 (2.735)	10,929 (10.71)	20,377 (16.28)	1,711 (3.62)	NS	3,086.1 (3.168)

Table 11. Chipps Island midwater trawl **late-fall run** raw catch, catch per cubic meter X's 10,000 (in parenthesis), and average (Aver) catch and CPM³ per year for the 1994 through 1998 field seasons. Peak catch per cubic meter values are highlighted. NS = Not sampled.

Field season	Aug	Sep	Oct	Nov	Dec	Jan	Feb	Mar	Apr	May	Jun	Jul	Aver
1993 - 1994	NS	NS	NS	8 (0.030)	53 (0.0789)	2 (0.005)	5 (0.0134)	0	0	0	0	NS	8.5 (0.016)
1994 - 1995	NS	NS	0	5 (0.023)	49 (0.0725)	34 (0.0399)	0	0	0	1 (0.001)	0	0	8.9 (0.014)
1995 - 1996	0	1 (0.006)	1 (0.015)	0	10 (0.184)	20 (0.039)	1 (0.002)	0	0	1 (0.005)	0	0	2.8 (0.021)
1996 - 1997	0	NS	0	0	74 (0.112)	12 (0.022)	0	0	0	0	0	0	7.8 (0.012)
1997 - 1998	5 (0.015)	6 (0.051)	6 (0.02)	5 (0.031)	49 (0.083)	12 (0.011)	0	0	0	0	0	NS	7.5 (0.019)

Table 12. Chipps Island midwater trawl **winter run** raw catch, catch per cubic meter X's 10,000 (in parenthesis), and average (Aver) catch and CPM³ per year for the 1994 through 1998 field seasons. Peak catch per cubic meter values are highlighted. NS = Not sampled.

Field season	Aug	Sep	Oct	Nov	Dec	Jan	Feb	Mar	Apr	May	Jun	Jul	Aver
1993 - 1994	NS	NS	NS	0	0	1 (0.002)	2	29 (0.083)	14	1 (0.001)	0	NS	8.0 (0.013)
1994 - 1995	NS	NS	0	0	0	10 (0.011)	38 (0.325)	109 (0.437)	151	4 (0.004)	0	0	31.2 (0.111)
1995 - 1996	0	0	0	0	4 (0.064)	38 (0.065)	33 (0.112)	239 (0.595)	39 (0.085)	3 (0.001)	0	0	29.7 (0.077)
1996 - 1997	0	NS	0	0	1 (0.009)	11 (0.016)	33 (0.081)	72 (0.253)	44 (0.129)	2 (0.002)	0	0	14.8 (0.045)
1997 - 1998	0	0	0	0	6 (0.01)	17 (0.026)	4 (0.017)	54 (0.217)	29 (0.062)	2 (0.002)	0	NS	10.2 (0.031)

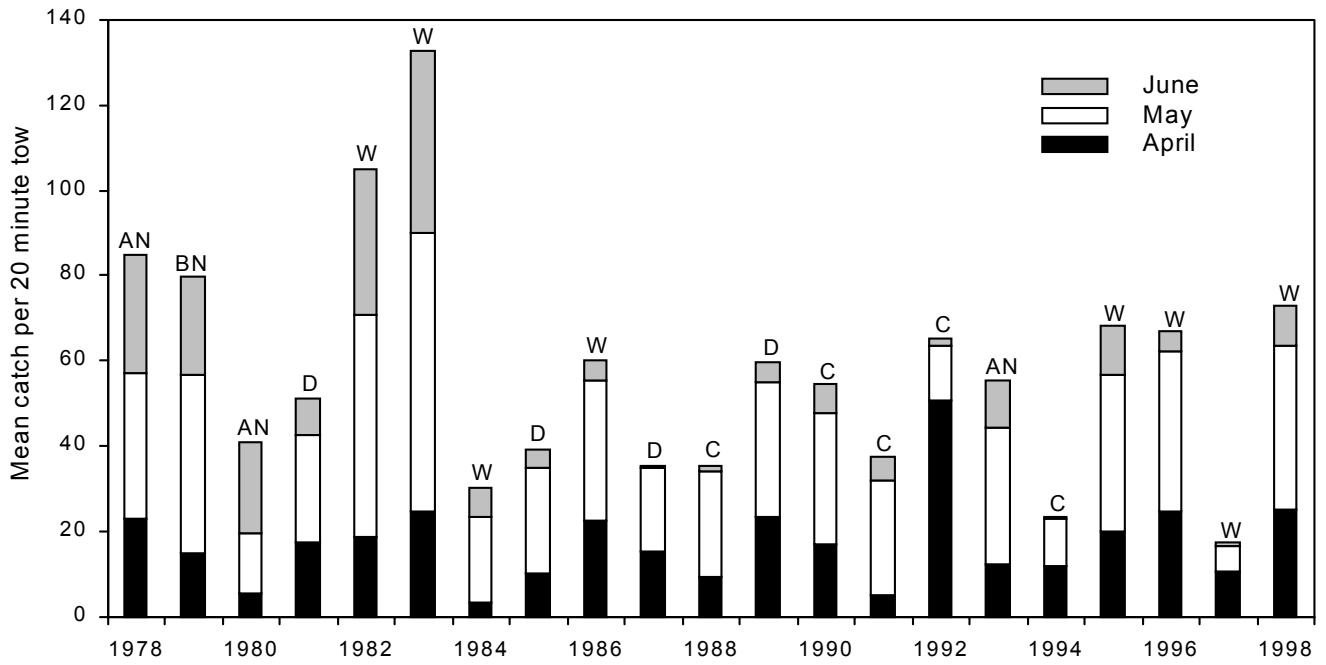

Figure 22. Mean catch of salmon smolts per 20 minute tow with Chipps Island midwater trawl in April, May, and June from 1978 through 1998. The water year type is included for each year (W=wet, AN=above normal, BN=below normal, D=dry, and C=critical).

Bay Seine

1997 field season

On January 28, 1997, using a subset of historical seine sites from the 1980's, the office began the Bay Seine, to determine if fry were present in the San Francisco Bay. Seining was conducted between January and March. Ten seine sites were separated into two seine routes of five sites sampled per week. During the 1997 season, 23 fall/spring run chinook were captured with a fork length range between 35 and 64 mm; four in January, 17 in February, and two in March.

1998 field season

In 1998, seining was conducted from January through March. A total of 118 fall/spring were captured, five times the number of chinook captured in 1997. The size range of the 1998 fall/spring was also greater than in 1997 (33 - 81 mm).

Figure 23 shows catch per year for 1976 and 1980, CPM³ for 1981 through 1998, and the associated delta outflow. The graph shows some relationship between wet years and use of the bays for rearing. It is thought that during high flow years more fry are pushed downstream into the bay, and conversely during lower flow years, fewer fry are found in the bays. The 1976 field season, a critically dry year produced one juvenile chinook, while the 1980 season was an above average rainfall year, and 197 juveniles were captured. In 1981, CPM³ was low during a dry year. The next two year CPM³ increased during wet years, but the third wet year, 1984, produced a lower CPM³ than 1981. Then during the following two years, 1985 and 1986, dry and wet years respectively, the associated CPM³ were low and then the highest recorded. When the Bay seine restarted in 1997, a wet year, CPM³ was as low as 1981, but 1998, also a wet year a higher CPM³ was recorded.

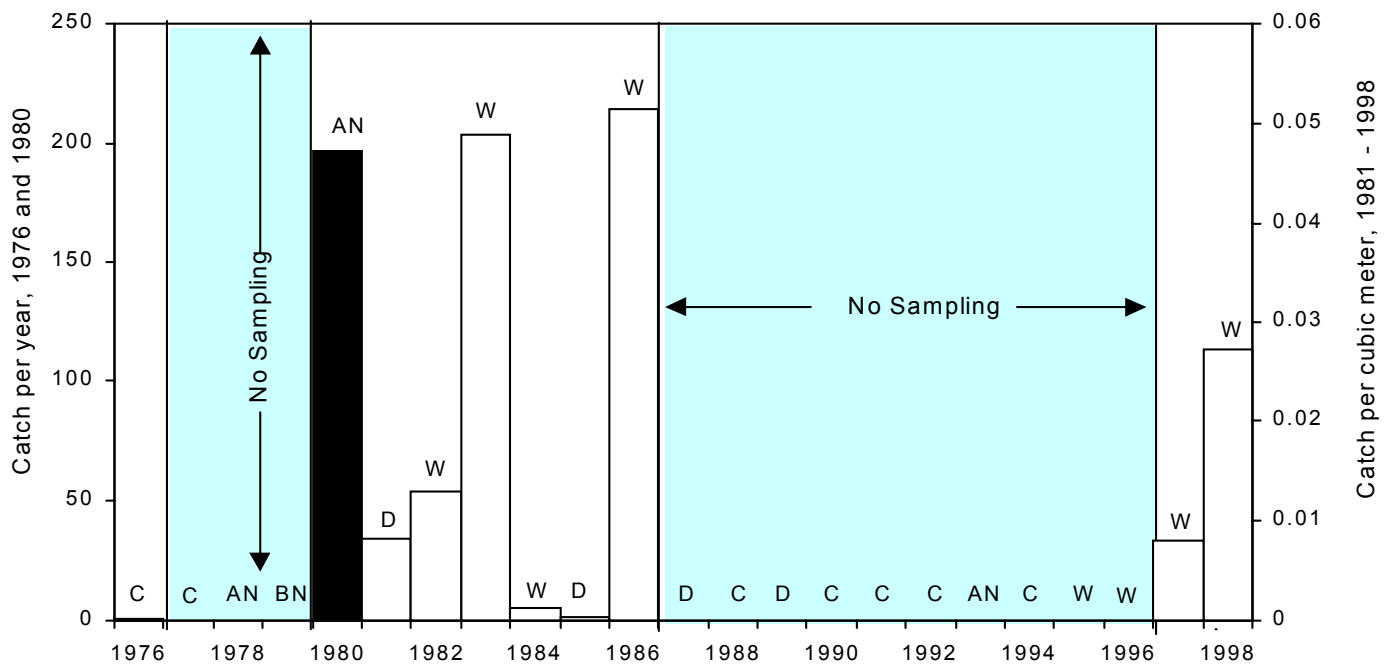

Figure 23. Mean yearly catch *per cubic meter* for all chinook salmon races, from 1981 through 1998. For the 1976 and 1980 field seasons, total catch per year is given. The water year type is included for each year (W=wet, AN=above normal, BN=below normal, D=dry, and C=critical).

Absolute Abundance Estimates

To estimate the absolute abundance of out migrating juveniles in 1997 and 1998, catches were expanded based on estimates of Chipps Island trawl recovery rates. The trawl recovery rate for each year was calculated using information from tagged fish recovered at Chipps Island and in the ocean fishery.

The yearly mean trawl recovery rate was calculated by averaging trawl recovery rates for each tag group within a year.

The trawl recovery rate at Chipps Island was estimated based on the following formulas:

Trawl recovery rate = # captured at Chipps Island / # available for capture at Chipps Island, adjusted for time,

where

the # captured = the number of a particular tag code recovered at Chipps Island,

the # available for capture at Chipps Island adjusted for time = (# surviving Chipps Island)(fraction of time sampled),

survival to Chipps Island = recovery rate in the ocean fishery of the upstream tag group / recovery rate in the ocean fishery of the control group (Benicia, Port Chicago, or Ryde),

the # surviving to Chipps Island = (# surviving to Chipps Island) / (# released),

the fraction of time sampled = minutes sampled during the recovery period / (total minutes during the recovery period)(1440 minutes / day),

and

the recovery rate in the ocean fishery = expanded # of a particular tag code recovered in ocean fishery / number released.

If the control groups (Port Chicago or Benicia) had unusually low ocean recovery rates relative to the upstream groups, the resulting trawl recovery estimate would be greater than 1.0. Ryde, approximately 25 miles upstream was used as a control group when recovery estimates were greater than 1.0. Mean trawl recovery values between 1980 and 1998 (excluding 1987) ranged between 0.0034 and 0.0329 and averaged 0.0101 (Figure 24 and Appendix 1).

There were no control releases in 1987 thus no estimate of trawl recovery rate was obtained for that year. Groups with survival greater than 1.0 were not used in the calculation of trawl recovery rates because they were outside the boundaries of reasonable estimates. Survival values equal to 0.0 were not used as well, because recovery rates could not be estimated using null values. Although there were many assumptions associated with these estimates of trawl recovery, they did provide a general assessment of trawl recovery at Chipps Island.

Because some of the downstream recovery rates compared to the upstream rates for 1998 exceeded 1.0, they were excluded from the mean trawl efficiency.

Juvenile fall/spring run chinook estimates for the season shown in Table 13, consist of fry and smolt captures between August 1, and July 31 of the next year. Estimates during 1998 were similar to 1994 and 1996, and over twice that of 1997. A reason for the higher estimates during 1998 could be the

increased effort over a six week period.

Absolute abundance of fall run for all years was also estimated by expanding the juvenile catch at Chipps Island using the mean trawl recovery rate. Past expansions using the fraction of time and channel width sampled using coded wire tagged fish recovered at Chipps Island have estimated survival to be greater than 1.0 at times. This may indicate that due to the tidal flux at Chipps Island, the same group of fish was being sampled repeatedly (fish may be moving past Chipps Island more than once due to tidal effect). This would overestimate survival. Sampling was also done during the day which typically yielded higher catches than at night (Wickwire and Stevens, 1966) which would also have biased the survival estimates high. It was assumed for expansion that the coded wire tagged smolts passing Chipps Island were equally distributed in both space (across the channel) and time.

The juvenile winter run estimate was 233,931 caught between December 30, 1996 and May 8, 1997, and 156,195 caught between December 4, 1997 and May 2, 1998. The 1997 estimate was consistent with trends seen in escapement (Figure 1), however, the 1998 estimate was surprisingly low. A reason for this has not been established.

A total of 86 late-fall yearlings were captured at Chipps Island between August 1996 and January of the 1997 field season representing the 1996 brood stock. One 1996 brood year late-fall fry was captured during May of the 1996 field season. Combining these two seasons catches yielded an estimated abundance of 90,606 late-fall for the 1996 brood year. This low estimate correlated well with the unusually low escapement estimate observed at Red Bluff during 1996 (Figure 1).

Appendix 1 shows total catch, fraction of time sampled, and the corresponding abundance estimates based on the overall trawl recovery for the years 1980 to 1998 (excluding 1987). It is likely that efficiencies during the wet years such as 1998 are relatively low due to high outflow. Ocean data in future years will provide information to evaluate this possibility.

Figure 25 shows yearly abundance estimates at Chipps Island between April 1 and June 30 from 1978 through 1998 using the trawl recovery rate for each year. This graph provides a general index of the absolute production of chinook passing Chipps Island between April and June from 1978 to 1998.

Catch per cubic meter at Chipps Island of smolts between April and June is significantly correlated with mean flow at Rio Vista (cfs) between 1978 and 1998 (Figure 26). This relationship shows that salmon smolt density increases during higher outflow.

If the mean density of smolts captured between April and June is divided by the trawl recovery rate for each year and plotted with flow, the relationship is improved (Figure 27), indicating that trawl recovery rates likely vary between years. Correcting for these differences in recovery rates improves the observed relationship and validates the use of this methodology.

Table 13. Fall/spring, late-fall, and winter run chinook abundance estimates for 1994 through 1998.

Year/race	Catch	Trawl Recovery Rate	Estimated Abundance
1993 - 1994 Fall/spring	5,898	0.0034	14,776,389
1994 - 1995 Fall/spring	19,700	0.0075	22,724,486
1995 - 1996 Fall/spring	17,092	0.0126	15,980,777
1996 - 1997 Fall/spring	3,957	0.0079	7,072,818
1997 - 1998 Fall/spring	33,947	0.0085	17,890,467
1993 - 1994 Winter	47	0.0034	201,613
1994 - 1995 Winter	312	0.0075	623,103
1995 - 1996 Winter	356	0.0106	466,860
1996 - 1997 Winter	163	0.0079	233,931
1997 - 1998 Winter	112	0.0085	156,195
1994 Brood Year Late-fall	0 (fry) 88 (yearling)	0.0034 0.0075	0 106,950
1995 Brood Year Late-fall	1 (fry) 33 (yearling)	0.0075 0.0104	989 <u>119,673</u> 120,662
1996 Brood Year Late-fall	1 (fry) 86 (yearling)	0.0106 0.0103	726 <u>89,880</u> 90,606
1997 Brood Year Late-fall	0 (fry) 83 (yearling)	0.0079 0.0079	0 101,788
1998 Brood Year Late-fall*	0 (fry)	0.0085	0

* This estimate only includes fry captures during the 1998 field season.

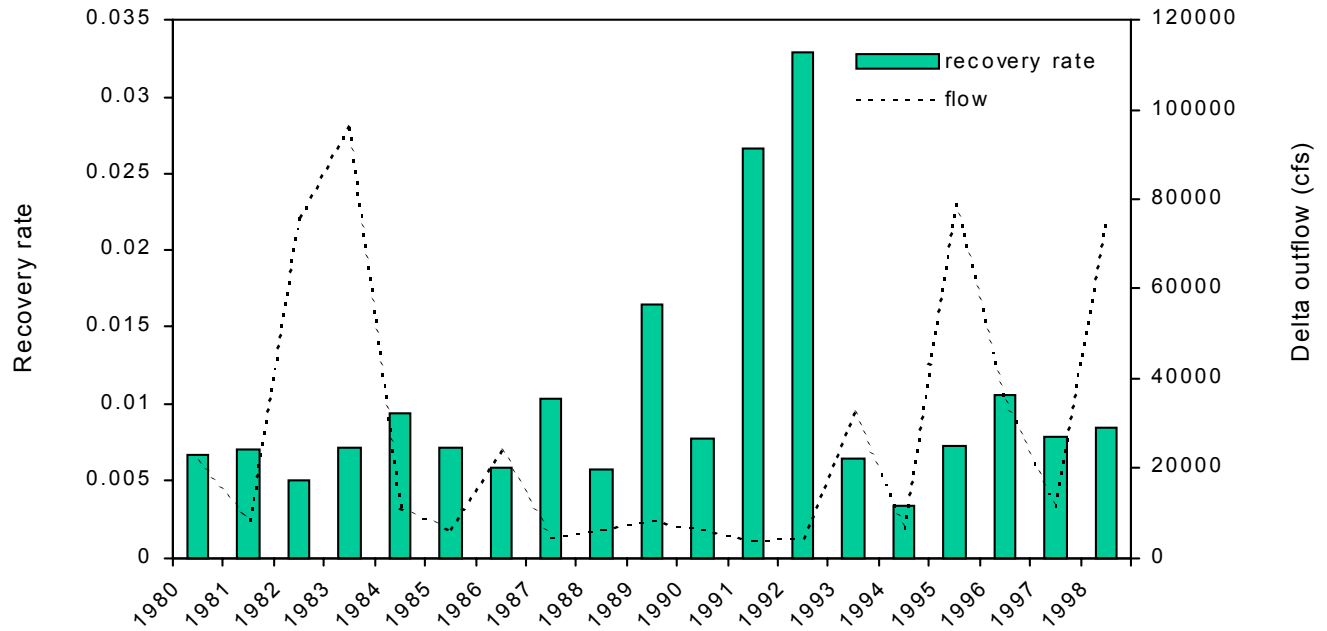

Figure 24. Recovery rate of fall run chinook in the midwater trawl at Chipps Island between 1980 and 1998 with Delta outflow. No control releases were conducted during 1987. The mean rate of recovery between 1980 and 1996 (excluding 1987) was used for 1987.

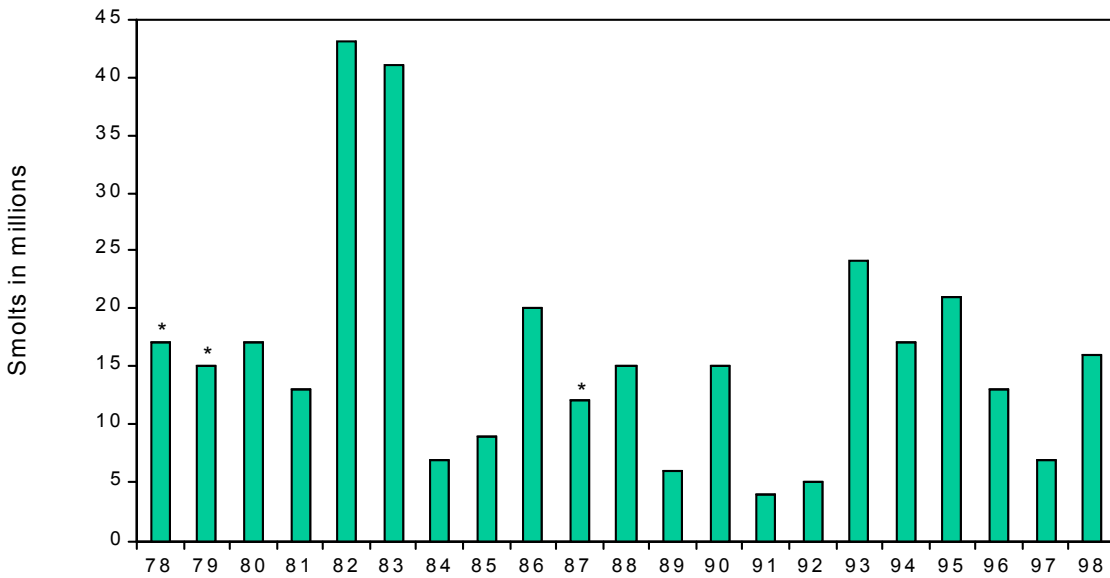

Figure 25. Absolute estimates of smolt abundance at Chipps Island between April 1 and June 30, from 1978 to 1998 using trawl recovery rates calculated from ocean recoveries. (*) = mean trawl recovery between 1980 and 1996 (excluding 1987).

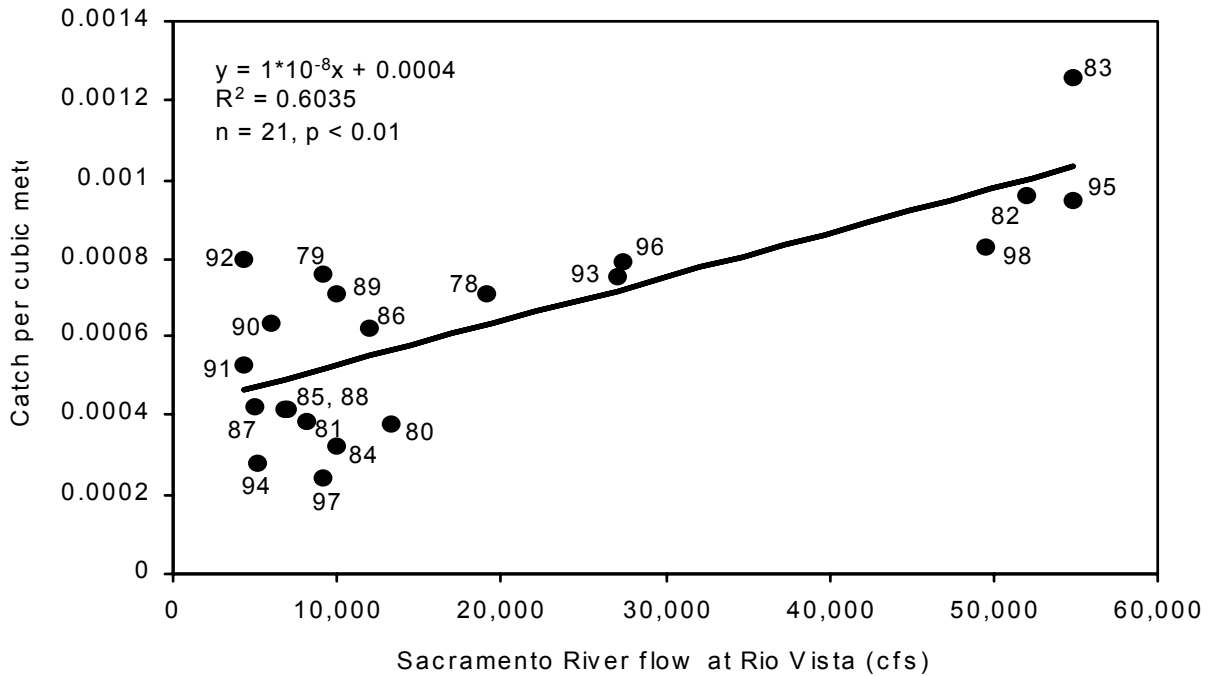

Figure 26. Mean catch of unmarked chinook salmon smolts per cubic meter in the midwater trawl at Chipps Island between April and June of 1978 to 1998 versus mean daily Sacramento River flow at Rio Vista between April and June in cfs.

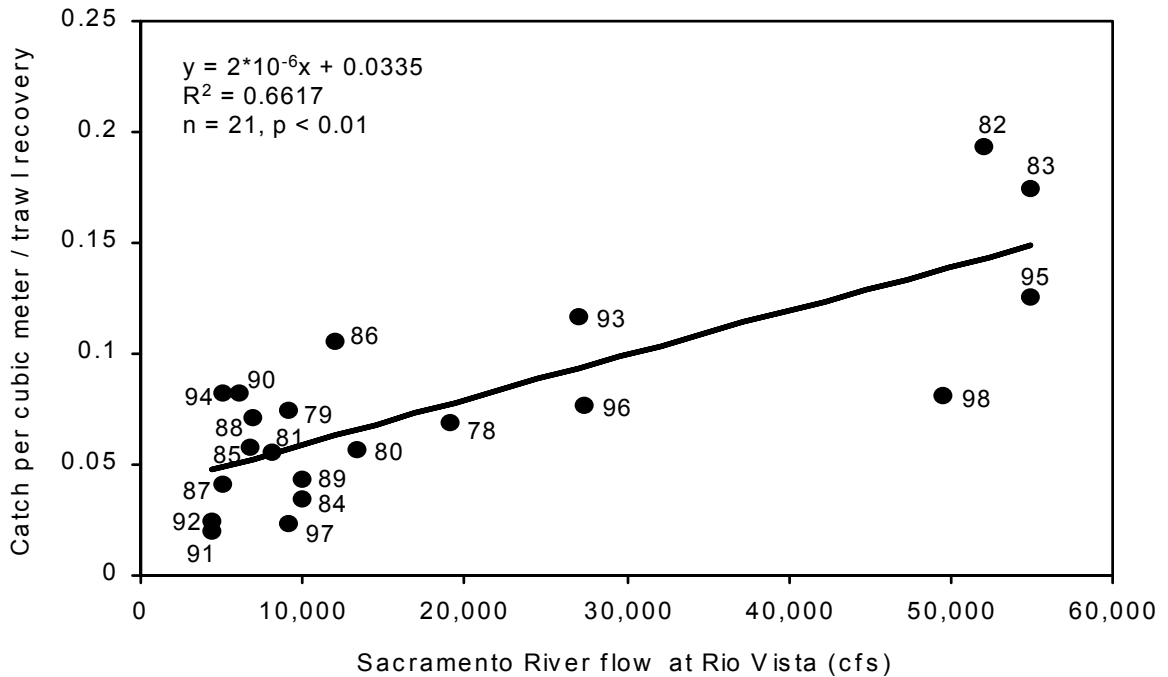

Figure 27. Catch of unmarked smolts per cubic meter at Chipps Island divided by the recovery rate based on CWT studies versus mean daily flow at Rio Vista (April-June) in cfs, from 1978 to 1998. Mean recovery rates for years 1980 to 1996 (excluding 1987) were used as recovery rate during 1978, 1979, 1987, and 1997 and 1998 due to lack of control releases and or data availability.

1997 Mark and Recapture Studies

Three separate mark and recapture experiments were conducted in 1997. Recoveries of all marked groups were made via a mid-water trawl at Chipps Island. Relative survival at Chipps Island was calculated using the following equation:

$$\times = (\# \text{fish recovered} / \# \text{fish released}) * (\text{Fraction of time sampled}) * (\text{percent of channel sampled}).$$

Late Fall-Run Experiments (Delta Action 8)

Two groups of Coleman NFH late-fall chinook (Table 1) were released on December 2 and January 14 at Miller Park on the Sacramento River with a third group released December 30 at Benicia as a control. The delta cross channel gates were closed throughout these experiments. The study was intended to evaluate survival over two different Export/Inflow (E/I) ratios, 50-65% in December and a 35% E/I ratio in January. Unregulated flows from storm runoff resulted in lower E/I ratios than were originally planned. Actual E/I ratio varied from date of release to date of last catch of marked salmon from 5% to 49% (avg. 20%) for the December 2 release and from 0% to 2% (avg. 0.06%) for the January 14 release.

Table 1. Survival indices and expanded SWP and CVP salvage numbers for late fall run releases made in the Sacramento / San Joaquin River Delta in 1997.

Release Date	Release Site	Number Released	Average FL of Fish (mm)	Truck Temp. (°F)	River Temp. (°F)	Survival Index	Expanded SWP Salvage	Expanded CVP Salvage	% of Release Salvaged
12/02/96	Miller Park	55,425	117	52	54	0.34	6	0	0.01%
12/30/96	Benicia	51,049	118	56	57	N/A	0	0	0.0%
01/14/97	Miller Park	48,046	118	41	45	0.23	0	0	0.0%

Sacramento River Fall-Run Survival Index

In 1997 three sets of CWT fish from Feather River Fish Hatchery were released from the Broderick boat ramp in West Sacramento (Table 2) to estimate survival over the peak period of outmigration of natural fall run chinook salmon. One control group was released at Port Chicago (Concord Naval Weapons Station). Previous releases were made at Miller Park in Sacramento but ramp construction prompted a change to the West Sacramento Broderick boat ramp in 1997. The Broderick releases occurred on April 15, May 1 and May 15, and the control group was released May 5.

Table 2. Survival indices and expanded SWP and CVP salvage numbers for fall run releases made in the Sacramento / San Joaquin River Delta in 1997.

Release Date	Release Site	Number Released	Average FL of Fish (mm)	Truck Temp. (°F)	River Temp. (°F)	Survival Index	Expanded SWP Salvage	Expanded CVP Salvage	% of Release Salvaged
04/15/97	West Sacramento	50,673	95	48	63	0.43	0	0	0.0%
05/01/97	West Sacramento	52,144	102	48	63	0.40	0	0	0.0%
05/05/97	Port Chicago	48,488	99	58	64	N/A	0	0	0.0%
05/15/97	West Sacramento	50,221	107	52	72	0.02	0	0	0.0%

In previous wet years survival indices ranged between 0.58 and 1.11 compared with 1997 indices of between 0.02 and 0.43. It is important to note in Table 3 the large difference between truck temperature

and river temperature. Even though one expects higher survival in wet years, the 15 to 20 degree temperature difference helps to explain the lower survival indices in 1997 (Table 3).

Table 3. Historical releases at Miller Park (Sacramento) 1988-1996 and Broderick Boat Ramp (West Sacramento) 1997-1998, water year type, truck water and river water temperature at release, temperature difference and survival index. Prior to 1998 temperatures were measured in °F, for 1998 temperatures were measured in °C and a conversion to °F is provided.

Release Date	Water Year Type	Truck Temperature °F unless noted	River Temperature °F unless noted	Temperature Difference °F unless noted	Survival Index
05/05/88	critical	54	62	+8	0.65
06/23/88	critical	55	74	+19	0.08
06/01/89	dry	51	67	+16	0.16
06/14/89	dry	58	70	+12	0.20
05/07/90	critical	56	70	+14	1.06
04/25/91	critical	54	62	+8	0.78
04/29/91	critical	59	62	+3	0.49
04/23/93	above normal	53	61	+8	0.63
05/03/93	above normal	56	62	+6	0.43
05/21/93	above normal	51	65	+14	0.35
05/28/93	above normal	55	64	+9	0.75
05/03/94	critical	52	67	+15	0.07
05/24/94	critical	49	71	+22	0.00
05/01/95	wet	59.5	58.5	-1	0.63
04/25/96	wet	48	57	+9	1.11
05/06/96	wet	48	65	+7	0.58
04/15/97	wet	48	63	+15	0.43
05/01/97	wet	48	63	+15	0.40
05/15/97	wet	52	72	+20	0.02
04/15/98	wet	10°C (50°F)	13°C (55.4°F)	+3°C (+5.4°F)	0.66
04/27/98	wet	15°C (59°F)	16°C (60.8°F)	+1°C (+1.8°F)	0.67
05/15/98	wet	12°C (53.6°F)	14°C (57.2°F)	+2°C (+3.6°F)	0.93

VAMP Releases

The 1997 Vernalis Adaptive Management Plan (VAMP) study involved releases of CWT chinook at three locations along the San Joaquin River, Mossdale, Dos Reis, and Jersey Point. Tagged chinook salmon were released to evaluate flow and export conditions, as set by the VAMP agreement and the placement of a temporary barrier at the head of Old River. Releases occurred April 28 and 29 at Mossdale and Dos Reis respectively with releases following May 2 at Jersey Point, May 8 at Dos Reis, May 12 at Jersey Point. A final release was made May 27 at Dos Reis after the VAMP period had ended. Flows for ten days after release averaged between 4,529 to 5,962 cubic feet per second (cfs), and average exports varied from 2,082 to 2,591 cfs. Post VAMP flows averaged 3,302 cfs with exports averaging 6,786 cfs. For 1997, both Merced River Fish Hatchery and Feather River Fish Hatchery fish were released at Dos Reis on April 29 and at Jersey Point on May 2 in order to evaluate potential differences in survival of the stocks. It appeared that Feather River stock survived at a higher rate than Merced River stock but this may be due in part to the comparatively larger size of the Feather River stock. It also appeared that installation of the temporary barrier at Head of Old River increased survival from past years when no barrier was present. For full write up and analysis on the VAMP results see (Brandes and Pierce 1998).

Table 4. Survival indices and expanded SWP and CVP salvage numbers for fall run releases made in the Sacramento / San Joaquin River Delta in 1997.

Release Date	Release Site	Number Released	Average FL of Fish (mm)	Truck Temp. (°F)	River Temp. (°F)	Survival Index	Expanded SWP Salvage	Expanded CVP Salvage	% of Release Salvaged
04/28/97	Mossdale	48,774	100	50	60	0.19	34	192	0.46%
04/29/97	Dos Reis	102,480	74	56	60	0.15	130	264	0.38%
04/29/97	Dos Reis *	49,830	97	51	60	0.19	29	96	0.25%
05/02/97	Jersey Point	51,588	75	55	64	0.50	12	12	0.05%
05/02/97	Jersey Point *	49,864	99	48	63	1.03	0	0	0.0%
05/08/97	Dos Reis	46,728	75	57	66	0.12	54	24	0.17%
05/12/97	Jersey Point	47,254	74	58	67	0.40	2	12	0.03%
05/27/97	Dos Reis	49,139	77	55	68	0.17	36	312	0.71%

* Feather River Fish Hatchery stock, note the difference in size between FRFH and MRFH

1998 Mark and Recapture Studies

Three separate experiments were conducted in 1998. Survival indices are based on recoveries of each marked group with a mid-water trawl net at Chipps Island.

Late Fall Experiments (Delta Action 8)

Five groups of Coleman NFH late-fall chinook were released as two paired releases and one control group. The first paired release occurred on December 4 and 5 at Georgiana Slough and Ryde. The control group was released December 29 and the final pair was released January 13 and 14, 1998. These releases are meant to show differences in survival between mainstem Sacramento River (Ryde) and the interior delta (Georgiana Slough). Table 5 shows release dates, locations and survival index calculated by using recovery numbers from Chipps Island. The second set of releases shows a higher survival index than the first pair coinciding with a lower average E/I ratio for the period from release to date of last capture.

Table 5. Survival indices and expanded SWP and CVP salvage numbers for late fall run releases made in the Sacramento / San Joaquin River Delta in 1997.

Release Date	Release Site	Number Released	Average FL of Fish (mm)	Truck Temp. (°C)*	River Temp. (°C)*	Survival Index	Expanded SWP Salvage	Expanded CVP Salvage	% of Release Salvaged
12/04/97	Georgiana Slough	61,276	127	12	11	0.03	101	52	0.25%
12/05/97	Ryde	46,756	123	12	11	0.67	18	8	0.06%
12/29/97	Port Chicago	48,080	127	11	9	N/A	0	0	0.0%
01/13/98	Georgiana Slough	66,893	140	11	10	0.26	0	24	0.04%
01/14/98	Ryde	49,059	142	10	10	0.94	0	0	0.0%

* 1998 marks the first year that Celsius scale is used

The export inflow (E/I) ratio varied from date of release to date of last catch of marked salmon from 2% to 63% (avg 30%) for the December 4-5 releases and from 1% to 18% (avg 4%) for the January 13-14 releases.

Sacramento River Fall Survival Index

In 1998 two sets of experimental fish were released from the Broderick boat ramp in West Sacramento, and one control group was released at Benicia. All releases were made with Feather River Fish Hatchery fish, (Table 6). This experiment is an ongoing annual index of survival of Sacramento River fall run. The releases are spaced apart in an attempt to approximate survival over the period of peak natural outmigration. In wet years such as 1998 survival is expected to be higher than in dry or critical years, Table 3 shows higher survival indices over dry years and similar numbers for wet years with low differences truck and river temperatures. Figure 1 shows the strong relationship between river temperature and survival to Chipps Island. As river temperature increases, survival decreases ($r^2=0.40$, $p=0.0016$). The Miller Park release in 1990 was an outlier (indicated in figure) however, when the data point was removed the relationship did not change significantly.

Table 6. Survival indices and expanded SWP and CVP salvage numbers for fall run releases made in the Sacramento / San Joaquin River Delta in 1997.

Release Date	Release Site	Number Released	Average FL of Fish (mm)	Truck Temp. (°C)*	River Temp. (°C)*	Survival Index	Expanded SWP Salvage	Expanded CVP Salvage	% of Release Salvaged
04/15/98	West Sacramento	21,402	83	10	13	0.73	0	0	0.0%
	West Sacramento	21,691	83	10	13	0.59	0	0	0.0%
	Group	43,093				0.66	0	0	0.0%
05/07/98	Benicia	30,777	92	11	18	N/A	0	0	0.0%
05/15/98	West Sacramento	17,940	99	12	14	1.01	0	0	0.0%
	West Sacramento	16,600	99	12	14	0.86	0	0	0.0%
	Group	34,540				0.93	0	0	0.0%

* 1998 marks the first year that degree Celsius is used

VAMP Releases

The Vernalis Adaptive Management (VAMP) study is meant to evaluate the survival of CWT salmon smolts with the head of Old River barrier (HORB) in place. In 1998 flows on the San Joaquin River were too high to allow the installation of the HORB, so south delta survival was measured without the barrier. The first set of release (Table 7) show very high survival and little difference between Dos Reis and Mossdale release survival. This may be explained by the extremely high flows which allow a smaller percentage of water and fish to be diverted into Old River along with the possibility of increased survival of the fish that are diverted from the San Joaquin River. The second set of releases included a group released at Lighthouse Marina on the Mokelumne River this release was used as a downstream control group for the trawling done at Jersey Point. The second release showed markedly lower survival under slightly changed but still favorable hydrologic conditions. These lowered survival indices may be partly explained by an outbreak of Infectious Hematopoietic Necrosis (IHN) at the Feather River hatchery which led to higher than usual mortality for these groups at the hatchery. For full write up and analysis on the VAMP results see Pierce and Brandes, 1999. Flows for both sets of experiments were high averaging 22,000 cfs for the first set and 18,500 cfs for the second set. Combined exports averaged 1,500 cfs for the first set and 1,800 cfs for the second set.

Table 7. Survival indices and expanded SWP and CVP salvage numbers for fall run releases made in the Sacramento / San Joaquin River Delta in 1998. Note that the first set of releases were made with Merced River stock and the second set of releases were made with Feather River stock.

Release Date	Release Site	Number Released	Average FL of Fish (mm)	Truck Temp. (°C)	River Temp. (°C)	Survival Index	Expanded SWP Salvage	Expanded CVP Salvage	% of Release Salvaged
04/16/98	Mossdale	26,465	86	12	14	0.47	0	12	0.05%
	Mossdale	25,264	86	12	14	0.60	0	24	0.09%
	Mossdale	25,926	86	12	14	0.61	0	12	0.05%
	Group	77,655				0.56	0	48	0.06%
04/17/98	Dos Reis	26,215	86	12	15	0.65	0	0	0.0%
	Dos Reis	26,366	86	12	15	0.47	0	0	0.0%
	Dos Reis	24,792	86	12	15	0.67	0	0	0.0%
	Group	77,373				0.59	0	0	0.0%
04/20/98	Jersey Point	24,598	89	15	17		0	0	0.0%
	Jersey Point	25,673	89	15	17		0	0	0.0%
	Group	50,271				1.84	0	0	0.0%
04/23/98	Mossdale	15,553	84	12	19	0.06	0	72	0.46%
	Mossdale	18,400	84	12	19	0.13	0	120	0.65%
	Group	33,959				0.10	0	192	0.57%
04/24/98	Dos Reis	23,849	91	13	19	0.16	0	0	0.0%
	Dos Reis	24,252	91	13	19	.019	0	0	0.0%
	Group	48,101				0.13	0	0	0.0%
04/27/98	Lighthouse Marina	21,288	89	15	16	0.78	0	0	0.0%
	Lighthouse Marina	22,821	89	15	16	0.58	0	0	0.0%
	Group	44,109				0.67	0	0	0.0%
04/28/98	Jersey Point	15,139	78	15	19	0.46	0	0	0.0%
	Jersey Point	16,141	78	15	19	0.79	0	0	0.0%
	Group	31,280				0.93	0	0	0.0%
05/06/98	Mossdale	21,600	90	11	18	0.34	0	372	1.72%
	Mossdale	21,599	90	11	18	0.13	0	252	1.16%
	Group	43,199				0.24	0	624	1.44%

Figure
through

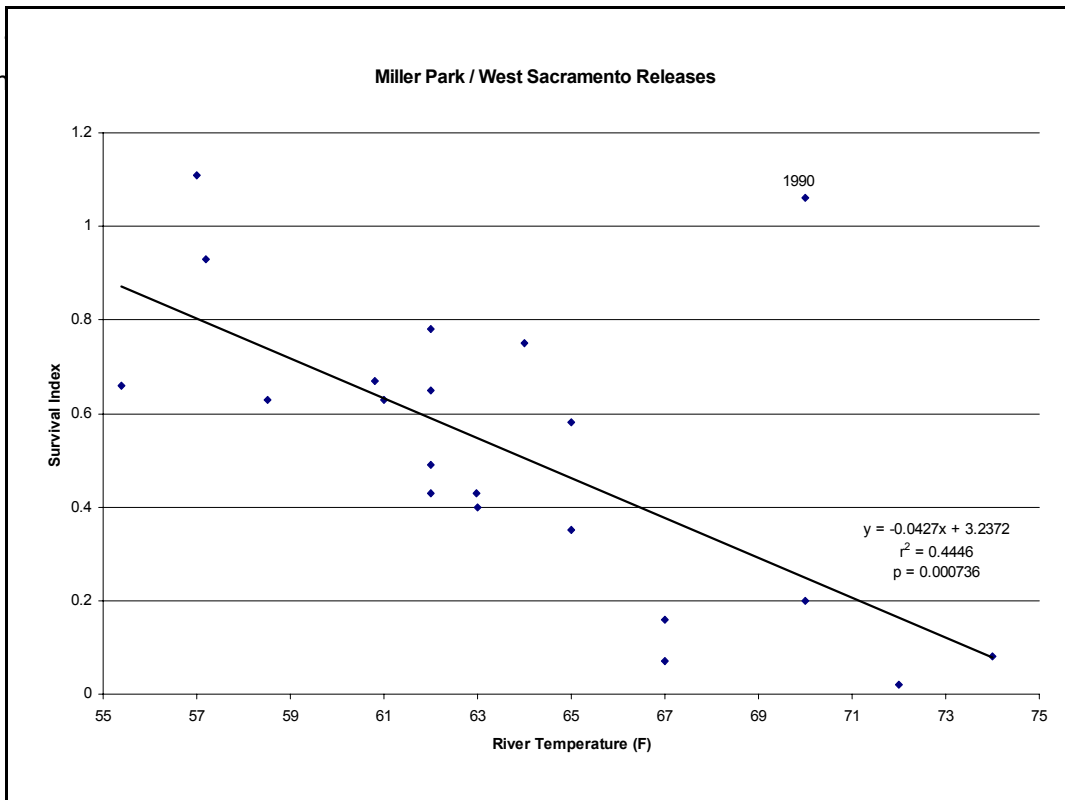

References

- Brandes, P.L., Pierce, M. 1998. 1997 Salmon Smolt Survival Studies in the South Delta. I.E.P. Newsletter. 11:1.
- Brandes, P.L., Pierce, M. 1999. 1997 Salmon Smolt Survival Studies in the South Delta. I.E.P. Newsletter. 11:1.
- Dauble, D.D., Page, T.L., Hanf, W.R. Jr. 1989. Spatial Distribution of Juvenile Salmonids in the Hanford Reach, Columbia River. Fishery Bulletin. 87:4.
- Healy, M.C. 1991. Life history of chinook salmon (*Oncorhynchus tshawytscha*). P 311- 394. In: Groot, C., and L. Margolis (eds.). Pacific Salmon Life Histories. UBC Press, Vancouver.
- Fisher, F.W. 1994. Past and present status of Central Valley chinook salmon. Conservation. Biol. 8(3): 870-873.
- Knowles, N., Cayan, D., Uncles, R., Ingram, L., and Peterson, D. 1997. Diagnosing the flood of 1997 in San Francisco Bay with observations and model results. Interagency Ecological Program Newsletter. 10(3): 28-31.
- Knowles, N., Cayan, D.R., Peterson, D.H., and Uncles, R.J. 1998. Simulated effects of Delta outflow on the Bay - 1998 compared to other years. Interagency Ecological Program Newsletter. 10(3): 28-31.
- United States Fish and Wildlife Service. 1981. Distribution and food habits of juvenile salmonids in the Duwamish Estuary, Washington 1980. USFWS Fisheries Assistance Office Olympia Washington.
- Reimers, P. E. 1968. Social behavior among juvenile fall chinook salmon. Journal of Fisheries Research Board of Canada. 25: 2005-2008.
- Slater, D.W. 1963. Winter-run chinook salmon in the Sacramento River, California with notes on water temperature requirements for spawning. U.S. Fish and Wildlife Special Science Report 461. Washington D.C.
- Thomas et al. 1969. Effect of yolk sac absorption on the swimming ability of fall chinook salmon. Trans. Amer. Fish. Soc. 3:406-410.
- United States Fish and Wildlife Service, 1993. Annual progress report "Abundance and survival of juvenile chinook salmon in the Sacramento-San Joaquin Estuary".
- United States Fish and Wildlife Service, 1994. Annual progress report "Abundance and survival of juvenile chinook salmon in the Sacramento-San Joaquin Estuary".

United States Fish and Wildlife Service, 1995. Annual progress report "Abundance and survival of juvenile chinook salmon in the Sacramento-San Joaquin Estuary".

United States Fish and Wildlife Service, 1995. "Working Paper on Restoration Needs. Habitat Restoration Actions to Double Natural Production of Anadromous Fish in the Central Valley of California". Volume 2.

United States Geological Survey, 1997. Water Resources data -- California water year 1996, Volume 4, Northern Central Valley basins and the Great Basin from Honey Lake Basin to Oregon State Line. Sacramento, CA.

United States Fish and Wildlife Service. 1987. Exhibit 31: The needs of chinook salmon, *Oncorhynchus tshawytscha* in the Sacramento-San Joaquin Estuary.

United States Geological Survey. 1995. California Data Exchange Center.

Wickwire, R.H., Stevens, D.E. 1966. Migration and distribution of young king salmon, *Oncorhynchus tshawytscha*, in the Sacramento River near Collinsville. Anadromous Fisheries Branch Administrative Report No. 71-4. California Department of Fish and Game.

Personal Communications

Colleen Harvey, California Department of Fish and Game, Red Bluff.

Appendix 1. Calculated efficiency rates for CWT smolts released throughout the Central Valley and recovered by trawl at Chipps Island between 1980 and 1998.

Trawl efficiency (the number caught by the midwater trawl divided by the number available for capture) is calculated by estimating the number surviving to Chipps (using the ocean index of survival) corrected by the time sampled.

Tag Code	Release Site	Release Date	Size at Release (mm)	Number Released	Ocean Recov.	Ocean Recov. Rate	Survival to Chipps	# surviving to Chipps	Time Fraction	available for capture	Number Captured	Trawl Efficiency	Mean Trawl Efficiency
+	+	+	+	+	+	+	+	+	+	+	+	+	+
1998													
6-1-6-5-1 & 2	B e n i c i a (FRH)	7-May-98	92	30,777	96	0.0031							
5-1-2-5-14 & 15, 5-1-2-6-1 through 6	Battle Creek (CNFH)	31-Mar-98	64	297,545	322	0.0011	0.346943	103,231	0.2520	26,014	23	0.0009	
5-1-2-6-7 through 9, 5-1-2-7-4	Battle Creek (CNFH)	7-Apr-98	63	149,294	291	0.0019	0.624893	93,293	0.2653	24,749	87	0.0035	
5-1-1-15-12	C a l d w e l l Park (LSFH)	9-Apr-98	78	21,271					0.2631		15		
5-1-2-6-10 through 15	Battle Creek (CNFH)	22-Apr-98	71	224,048	774	0.0035	1.107529						Unusually high recovery rate - not used in calculation
5-1-2-7-1, 2, 3, 5	Battle Creek (CNFH)	22-Apr-98	65	150,249	896	0.0060	1.911840						Unusually high recovery rate - not used in calculation
6-1-6-6-14 & 15	G r i d l e y (FRH)	30-Apr-98	78	84,750	400	0.0047	1.513127						Unusually high recovery rate - not used in calculation
6-1-13-1-14	Woodbridge Dam (MOK)	1-Mar-98	59	11,278	12	0.0011	0.341118	3,847	0.2627	1,011	13	0.0129	
6-1-6-4-10 & 11	Fremont Weir (FRH)	2-Mar-98	69	51,543	74	0.0014	0.460275	23,724	0.1432	3,396	9	0.0026	
6-1-6-4-12 & 13	Elkhorn Sl. Boat Ramp (FRH)	2-Mar-98	67	52,728	34	0.0006	0.206725	10,900	0.2652	2,891	10	0.0035	
6-1-6-5-7 & 8	W e s t Sacramento (FRH)	15-Apr-98	83	43,093	56	0.0013	0.416616	17,953	0.2652	4,761	58	0.0122	
6-1-11-8-9, Mossdale		16-Apr-98	86	77,655	152	0.0020	0.627522	48,730	0.2639	12,859	88	0.0068	

10, 11	(MRFF)												
6-1-11-8-6, 7, 8	Dos Reis (MRH)	17-Apr-98	86	77,373	140	0.0018	0.580088	44,883	0.2627	11,792	93	0.0079	
6-1-11-8-12 & 13	Jersey Point (MRH)	20-Apr-98	89	50,271	194	0.0039	1.237198	Unusually high recovery rate - not used in calculation					
6-1-13-1-15	Woodbridge Dam (MOK)	16-Apr-98	87	11,367	32	0.0028	0.902525	10,259	0.2653	2,722	10	0.0037	
6-2-32 & 33	New Hope Landing (MOK)	21-Apr-98	79	102,479	26	0.0003	0.081338	8,335	0.2663	2,219	76	0.0342	
6-1-6-5-5 & 6	Mossdale (FRH)	23-Apr-98	84	33,959	8	0.0002	0.075525	2,565	0.2656	681	7	0.0103	
6-1-14-6-6 & 7	Dos Reis (FRH)	24-Apr-98	91	48,101	37	0.0008	0.246605	11,862	0.1855	2,200	17	0.0077	
6-1-6-5-11 & 12	Lighthouse Marina (FRH)	27-Apr-98	89	44,109	109	0.0025	0.792236	34,945	0.2658	9,287	61	0.0066	
6-1-6-5-3 & 4	Jersey Point (FRH)	28-Apr-98	78	30,920	48	0.0016	0.497688	15,389	0.2655	4,085	40	0.0098	
6-2-34 & 35	Jersey Point (MOK)	28-Apr-98	86	103,356	98	0.0009	0.303980	31,418	0.2651	8,329	215	0.0258	
6-1-6-5-13 & 14	V e r o n a (FRH)	30-Apr-98	78	78,255	398	0.0051	1.630520	127,596	0.2353	30,025	83	0.0028	
6-1-6-6-9, 10, & 11	S F B a y - Wickland Oil (FRH)	4-May-98	96	54,033	415	0.0077	2.462318	Unusually high recovery rate - not used in calculation					
6-1-6-4-14 & 15	Mossdale (FRH)	6-May-98	90	43,199	92	0.0021	0.682762	29,495	0.2654	7,829	21	0.0027	
6-1-13-2-1	Woodbridge Dam (MOK)	7-May-98	92	12,351	60	0.0049	1.557414	Unusually high recovery rate - not used in calculation					
6-2-38 & 39	New Hope Landing (MOK)	14-May-98	101	102,670	444	0.0043	1.386419	Unusually high recovery rate - not used in calculation					

6-1-6-5-9 & 10	West Sacramento (FRH)	15-May-98	99	34,540	223	0.0065	2.069844	Unusually high recovery rate - not used in calculation					
6-1-13-2-2	Woodbridge Dam (MOK)	20-May-98	97	10,414	43	0.0041	1.323750	Unusually high recovery rate - not used in calculation					
6-25-20, 24 6-45-23	Upper Merced (MRFF)	12-Apr-98	83	100,062	515	0.0051	1.650035	Unusually high recovery rate - not used in calculation					
6-25-21, 22, 23	Lower Merced (MRFF)	14-Apr-98	85	74,109	115	0.0016	0.497487	36,868	0.2667	9,832	41	0.0042	
6-1-11-7-3 through 6	Upper Tuolumne (MRFF)	15-Apr-98	83	94,058	313	0.0033	1.066851	Unusually high recovery rate - not used in calculation					
6-1-11-7-7	Downstream of Tuol. R. (MRFF)	16-Apr-98	86	25,754	44	0.0017	0.547726	14,106	0.2632	3,713	18	0.0048	
6-1-11-7-8	Downstream of Tuol. R. (MRFF)	17-Apr-98	83	22,006	41	0.0019	0.597307	13,144	0.2654	3,488	20	0.0057	
6-1-11-7-9 through 12	Upper Merced (MRH)	3-May-98	85	103,996	348	0.0033	1.072797	Unusually high recovery rate - not used in calculation					
6-1-11-5-2 & 13	Lower Merced (MRH)	5-May-98	89	75,187	206	0.0027	0.878374	66,042	0.2673	17,651	34	0.0019	0.0085
1997													
6-1-6-3-1	Port Chicago (FRH)	5-May-97	99	48,538	591	0.0122							
6-1-6-2-15													
5-42-32 & 33	Battle Creek (CNFH)	7-Nov-96	108	127,460	152	0.0012	0.097941	12,484	0.0802	1,001	20	0.0200	
5-42-34 & 35	Battle Creek (CNFH)	10-Dec-96	132	123,015	1008	0.0082	0.672972	82,786	0.0738	6,112	35	0.0057	

5-42-36 & 37	Battle Creek (CNFH)	9-Jan-97	121	127,548	706	0.0055	0.454596	57,983	0.0769	4,461	28	0.0063
5 - 4 1 - 2 3 through 27 5-42-41	Battle Creek (CNFH)	16-Jan-97	135	362,933	3209	0.0088	0.726169	263,551	0.0718	18,918	78	0.0041
5-42-38, 39, 40	Battle Creek (CNFH)	17-Jan-97	132	185,632	1920	0.0103	0.849460	157,687	0.0713	11,250	42	0.0037
5-42-31	Miller Park (CNFH)	2-Dec-96	117	55,425	140	0.0025	0.207452	11,498	0.1391	1,599	20	0.0125
5-42-30	Miller Park (CNFH)	14-Jan-97	118	48,046	41	0.0009	0.070084	3,367	0.1316	443	11	0.0248
5 - 1 - 2 - 2 - 8 through 15 5-1-2-3-1	Battle Creek (CNFH)	1-Apr-97	72	288,499	1361	0.0047	0.387443	111,777	0.1373	15,346	52	0.0034
5-1-2-3-9 & 10 5-1-2-3-3	Battle Creek (CNFH)	9-Apr-97	71	97,229	266	0.0027	0.224688	21,846	0.1368	2,990	11	0.0037
5-1-2-3-2, 4 through 8, 11	Battle Creek (CNFH)	15-Apr-97	73	236,539	1261	0.0053	0.437831	103,564	0.1365	14,135	54	0.0038
5-1-2-4-1 & 2 5-1-2-3-12 through 15	Battle Creek (CNFH)	16-Apr-97	62	207,495	348	0.0017	0.137742	28,581	0.1329	3,798	17	0.0045
5-1-2-4-3, 4, 5	Battle Creek (CNFH)	6-May-97	72	104,100	126	0.0012	0.099406	10,348	0.1372	1,419	5	0.0035
6-48-6	Woodbridge (MOK)	16-Oct-96	161	42,807	5	0.0001	0.009593	411	-	0	0	
6-1-6-2-11 & 12	W e s t Sacramento (FRH)	15-Apr-97	95	50,673	470	0.0093	0.761756	38,600	0.1367	5,278	23	0.0044
6-49-10 & 11	New Hope L a n d i n g (MOK)	23-Apr-97	77	103,456	148	0.0014	0.117490	12,155	0.1387	1,686	16	0.0095
6-25-41 & 42	Gridley Boat Ramp (FRH)	24-Apr-97	97	105,266	543	0.0052	0.423649	44,596	0.1321	5,893	35	0.0059

6-2-31	San Pablo Bay (MOK)	24-Apr-97	86	52,317	289	0.0055	0.453680	23,735	0.1389	3,297	1	0.0003
6-25-43 & 44	Verona Boat Ramp (FRH)	24-Apr-97	96	99,318	823	0.0083	0.680560	67,592	0.1387	9,376	30	0.0032
6-1-6-3-2 & 3	Mossdale (w/ barrier) (FRH)	28-Apr-97	100	48,774	330	0.0068	0.555674	27,102	0.1375	3,725	10	0.0027
6-1-6-3-4 & 5	Dos Reis (FRH)	29-Apr-97	97	49,830	258	0.0052	0.425229	21,189	0.1366	2,894	11	0.0038
6-25-45 & 46	Dos Reis (MRFF)	29-Apr-97	74	102,480	350	0.0034	0.280494	28,745	0.1389	3,992	16	0.0040
6-49-12 & 13	Jersey Point (MOK)	30-Apr-97	73	104,000	455	0.0044	0.359313	37,369	0.1387	5,182	63	0.0122
6-1-6-2-13 & 14	West Sacramento (FRH)	1-May-97	102	52,144	499	0.0096	0.785942	40,982	0.1387	5,684	22	0.0039
6-1-6-2-7 & 8	Jersey Point (FRH)	2-May-97	99	49,864	697	0.0140	1.147995	Unusually high recovery rate - not used in calculation				
6-25-47	Jersey Point (MRFF)	2-May-97	75	51,588	354	0.0069	0.563571	29,074	0.1375	3,996	27	0.0068
6-25-48	Dos Reis (MRFF)	8-May-97	75	46,728	91	0.0019	0.159941	7,474	0.1189	889	5	0.0056
6-25-49	Jersey Point (MRFF)	12-May-97	74	47,254	191	0.0040	0.331963	15,687	0.1244	1,951	18	0.0092
6-1-6-2-9 & 10	West Sacramento (FRH)	15-May-97	107	50,221	91	0.0018	0.148816	7,474	0.1389	1,038	1	0.0010
6-25-50	Dos Reis (MRFF)	27-May-97	77	49,139	26	0.0005	0.043455	2,135	0.1121	239	7	0.0292
6-1-11-5-11	Upper Merced (MRFF)	20-Apr-97	77	26,045	22	0.0008	0.069373	1,807	0.1384	250	5	0.0200
6-1-11-5-11	Upper	20-Apr-97	77	110,538	41	0.0004	0.030463	3,367	0.1384	466	5	0.0107

through 13	M e r c e d												
6-1-11-6-12	(MRFF)												
6-1-11-5-15	L o w e r	22-Apr-97	75	104,487	279	0.0027	0.219299	22,914	0.1387	3,178	16	0.0050	
	M e r c e d												
6-1-11-6-1, 2, 3	(MRFF)												
6-1-11-6-7	U p p e r	22-Apr-97	71	93,507	68	0.0007	0.059725	5,585	0.1161	648	3	0.0046	
through 10	T u o l u m n e												
	(MRFF)												
6-1-11-6-4, 5, 6	L o w e r	23-Apr-97	75	72,464	213	0.0029	0.241408	17,493	0.1275	2,230	12	0.0054	
	T u o l u m n e												
	(MRFF)												
6-1-11-6-11	U p p e r	12-May-97	76	28,031	2	0.0001	0.005860	164	-		0		
	M e r c e d												
	(MRFF)												
6-1-11-6-14 & 15	L o w e r	14-May-97	67	92,157	5	0.0001	0.004456	411	0.1389	57	1	0.0175	0.0079
	M e r c e d												
	(MRFF)												

1996

6-1-14-5-6	Benicia	7-May-96	84	51,288	774	0.0151	1.000000	51,288			2		
5-1-2-1-14	Battle Creek	14-Mar-96	65	340,000	712	0.0021	0.138764	47,180	0.113	5,331	62	0.0116	
5-1-2-1-15	Battle Creek	29-Mar-96	68	308,443	1,367	0.0044	0.293676	90,582	0.1242	11,250	89	0.0079	
5-34-16&18	Battle Creek	29-Mar-96	121	61,858	261	0.0042	0.279589	17,295	0.0964	1,667	31	0.0186	
5-36-27 5-41-16	Battle Creek	9-Nov-95	119	126,584	424	0.0033	0.221953	28,096	0.0628	1,764	5	0.0028	
5-36-28	Battle Creek	11-Jan-96	127	65,457	391	0.0060	0.395818	25,909	0.0894	2,316	24	0.0104	
5-41-7&9	Battle Creek	8-Dec-95	125	140,814	963	0.0068	0.453164	63,812	0.0763	4,869	23	0.0047	
5-41-8 5-41-17&18	Battle Creek	3-Jan-96	128	201,469	1,513	0.0075	0.497629	100,257	0.0932	9,344	79	0.0085	
5-41-11	Port Chicago	16-Jan-96	145	34,596	270	0.0078	0.517145	17,891	???	0	20		
5-41-12	Courtland	9-Jan-96	131	34,961	228	0.0065	0.432141	15,108	0.1236	1,867	26	0.0139	

5-41-13	Georgiana Slough	10-Jan-96	125	33,670	146	0.0043	0.287332	9,674	0.113	1,093	5	0.0046
5-41-14	Ryde	11-Jan-96	122	30,494	243	0.0080	0.528040	16,102	0.1364	2,196	21	0.0096
5-41-19	Battle Creek	10-Jan-96	114	67,076	340	0.0051	0.335882	22,530	0.0845	1,904	13	0.0068
B6-12-02	Okie Dam	25-Jan-96		7,392	5	0.0007	0.044821	331		0	1	
6-1-14-5-13, 14, 15 6-1-14-6-5	Feather River	5-Apr-96	110	213,709	1,492	0.0070	0.462616	98,865	0.1416	13,999	110	0.0079
5-1-2-2-1	Battle Creek	23-Apr-96	80	268,960	1,934	0.0072	0.476479	128,154	0.1374	17,608	125	0.0071
6-1-6-1-3	Feather River	3-May-96	80	100,033	1,016	0.0102	0.673016	67,324	0.1371	9,230	58	0.0063
6-1-14-6-1 to 4	Yuba City	15-May-96	87	204,171	3,120	0.0153	1.012594	206,742	0.1198	24,768	248	0.0100
6-1-13-1-7	Woodbridge Dam	10-Apr-96	93	3,852	17	0.0044	0.292440	Unusually high recovery rate - not used in calculation				
6-1-14-5-5	Turner Cut	17-Apr-96	79	50,103	99	0.0020	0.130932	6,560	0.1363	894	5	0.0056
6-1-6-1-8	Miller Park	25-Apr-96	81	49,708	632	0.0127	0.842492	41,879	0.1364	5,712	58	0.0102
6-1-6-2-2	Miller Park	6-May-96	83	49,881	542	0.0109	0.720011	35,915	0.1359	4,881	30	0.0061
6-1-6-1-11, 12	Turner Cut	2-May-96	83	98,023	72	0.0007	0.048672	4,771	0.1306	623	4	0.0064
6-2-16,17	Mokelumne	15-May-96	91	102,069	489	0.0048	0.317461	32,403	0.1185	3,840	25	0.0065
6-2-20,21	Mokelumne	4-Jun-96	104	104,587	18	0.0002	0.011404	1,193	0.1389	166	1	0.0060
6-1-6-1-15	Mossdale	15-Apr-96	78	51,718	68	0.0013	0.087125	4,506	0.1389	626	2	0.0032
6-1-6-1-13	Jersey Point	18-Apr-96	78	50,041	330	0.0066	0.436981	21,867	0.131	2,865	25	0.0087
6-1-6-2-1	Mossdale	30-Apr-96	81	50,462	15	0.0003	0.019697	994	0.1389	138	1	0.0072
6-1-6-2-3 & 6-1-6-1-10	Dos Reis	1-May-96	84	98,638	69	0.0007	0.046353	4,572	0.1361	622	13	0.0209
6-1-11-4-12, 13, 14, 15	Dos Reis	1-May-96	84	107,961	105	0.0010	0.064446	6,958	0.1372	955	58	0.0608
6-1-6-1-9	Jersey Point	3-May-96	87	50,820	309	0.0061	0.402901	20,475	0.1359	2,783	24	0.0086

6-1-11-5-1	Jersey Point	3-May-96	77	51,737	180	0.0035	0.230540	11,927	0.1366	1,629	39	0.0239	
6-2-18,19	Jersey Point	20-May-96	94	103,221	2,043	0.0198	1.311521	135,376	0.1389	18,804	195	0.0104	
6-1-11-4-10	U p p e r Merced	25-Apr-96	80	22,638	2	0.0001	0.005854	133	0.1389	18	1	0.0543	
6-1-11-5-4	L o w e r Merced	26-Apr-96	93	22,019	8	0.0004	0.024075	530	0.1389	74	1	0.0136	
6-1-11-5-7,8	U p p e r Tuolumne	26-Apr-96	88	45,845	17	0.0004	0.024572	1,126	0.1389	156	3	0.0192	
6-1-11-5-9,10	U p p e r Tuolumne	27-Apr-96	90	50,608	16	0.0003	0.020950	1,060	0.1389	147	4	0.0272	
6-57-61	Woodbridge Dam	26-Sep-95	146	75,248	299	0.0040	0.263300	19,813	0.1389	2,752	1	0.0004	0.0126

1995

6-1-14-5-2	Ryde	01-May-95	81	51,597	647	0.0125							Rodeo used as control instead of Ryde
6-29-32 & 33	Rodeo	16-Jun-95		287,259	2,571	0.0090							
5-1-1-12-6 to 8	Battle Creek	24-Apr-95	73	152,187	1,166	0.0077	0.856037	130,278	0.1313	17,105	58	0.0034	
6-1-6-1-4 to 7	Feather River	03-Apr-95	49	196,964	1,459	0.0074	0.827637	163,015	0.1216	19,823	65	0.0033	
6-1-14-5-3	Miller Park	01-May-95	81	50,292	737	0.0147	1.637345						Unusually high recovery rate - not used in calculation
6-2-11 & 12	New Hope L.	18-Apr-95	80	97,876	705	0.0072	0.804794	78,770	0.1343	10,579	51	0.0048	
6-2-13 & 14	New Hope L.	25-Apr-95	83	99,462	625	0.0063	0.702093	69,832	0.1389	9,700	49	0.0051	
6-2-10	Thornton	15-Jun-95	95	51,757	211	0.0041	0.455496	23,575	0.1389	3,275	18	0.0055	
6-1-14-5-1 6-1-14-4-14	Mossdale	14-Apr-95	70	100,969	407	0.0040	0.450379	45,474	0.1344	6,112	23	0.0038	
6-1-14-4-12	Dos Reis	17-Apr-95	70	50,848	206	0.0041	0.452652	23,016	0.1331	3,063	8	0.0026	
6-1-14-4-13	Jersey Point	19-Apr-95	70	50,799	248	0.0049	0.545467	27,709	0.1381	3,827	25	0.0065	
6-31-50 & 51	Mossdale	05-May-95	76	102,562	340	0.0033	0.370394	37,988	0.1331	5,056	13	0.0026	
6-31-47	Dos Reis	05-May-95	76	52,097	354	0.0068	0.759210	39,553	0.1343	5,312	21	0.0040	
6-1-14-5-4	Mossdale	17-May-95	78	104,125	330	0.0032	0.008950	932	0.1386	129	8	0.0619	

6-31-48													
6-31-49	Dos Reis	17-May-95	77	51,665	221	0.0043	0.477933	24,692	0.1386	3,422	9	0.0026	
6-1-11-4-1 to 4	U p p e r Merced	03-May-95	84	111,288	655	0.0059	0.657604	73,183	0.1354	9,909	18	0.0018	
6-1-11-4-5 to 7	L o w e r Merced	04-May-95	82	83,016	213	0.0026	0.286675	23,799	0.1388	3,303	18	0.0054	
6-1-11-3-11 to 13	U p p e r Tuolumne	04-May-95	86	83,539	942	0.0113	1.259892	105,250	0.1311	13,798	21	0.0015	
6-1-11-3-14 & 15	L o w e r Tuolumne	05-May-95	89	53,539	583	0.0109	1.216662	65,139	0.1319	8,592	12	0.0014	0.0073
									0.1345				
1994													
6-31-44	Benicia	10-May-94		54,297	1,147	0.0211							
6-1-14-4-1	Ryde	12-Apr-94	76	51,819	376	0.0073	0.343488	17,799	0.1389	2,472	11	0.0044	
5-34-27 to 29	Battle Creek	14-Apr-94	70	160,805	795	0.0049	0.234035	37,634	0.1389	5,227	22	0.0042	
6-1-6-1-1	Feather River	16-Mar-94	61	103,558	189	0.0018	0.086395	8,947	0.1362	1,219	6	0.0049	
6-1-14-4-2	Georgiana Sl.	12-Apr-94	77	51,485	214	0.0042	0.196764	10,130	0.1389	1,407	3	0.0021	
6-1-14-4-3	Jersey Point	13-Apr-94	72	50,689	421	0.0083	0.393170	19,929	0.1389	2,768	10	0.0036	
6-1-14-4-6	Ryde	25-Apr-94	76	56,139	663	0.0118	0.559064	31,385	0.1389	4,359	11	0.0025	
6-1-14-4-7	Georgiana Sl.	25-Apr-94	73	50,235	151	0.0030	0.142293	7,148	0.1389	993	6	0.0060	
6-1-14-4-8	Jersey Point	27-Apr-94	78	53,810	748	0.0139	0.658038	35,409	0.1389	4,918	16	0.0033	
6-1-6-1-2	Feather River	02-May-94	81	100,377	102	0.0010	0.048104	4,829	0.1389	671	1	0.0015	
6-31-42	Miller Park	03-May-94	83	53,232	222	0.0042	0.197421	10,509	0.1389	1,460	4	0.0027	
6-1-14-4-4	Mossdale	26-Apr-94	77	50,726	87	0.0017	0.081190	4,118	0.1389	572	2	0.0035	
6-31-43	Mossdale	09-May-94	89	53,880	31	0.0006	0.027236	1,467	0.1389	204	1	0.0049	
6-48-1 & 2	New Hope L.	23-May-94	96	102,732	742	0.0072	0.341909	35,125	0.1389	4,879	19	0.0039	
6-48-3 & 4	New Hope L.	10-May-94	90	103,470	304	0.0029	0.139082	14,391	0.1291	1,858	11	0.0059	
6-1-11-2-10	M e r c e d	22-Apr-94	89	99,565	338	0.0034	0.160702	16,000	0.1389	2,222	6	0.0027	

to 13	Hatchery												
6-1-11-2-14 & 15 6-1-11-3-1	L o w e r Merced	22-Apr-94	87	82,091	232	0.0028	0.133784	10,982	0.1389	1,525	2	0.0013	
6-1-11-3-2 to 4	U p p e r Tuolumne	23-Apr-94	85	83,414	252	0.0030	0.143013	11,929	0.1389	1,657	3	0.0018	
6-1-11-3-5 & 6	L o w e r Tuolumne	24-Apr-94	82	50,055	152	0.0030	0.1438	7,195	0.1389	999	2	0.0020	0.0034
									0.1382				
1993													
6-31-37	Ryde	10-May-93	75	49,699	1116	0.0225							
6-1-14-3-5	Benicia (split r.)	7&15-Apr-93	58	53,066	434	0.0082							Ryde used as control instead of Port Chicago or Benicia
6-1-14-3-7	Benicia	15-Apr-93	63	49,335	530	0.0107							Ryde used as control instead of Port Chicago or Benicia
6-1-14-11-1 & 2	Battle Creek	13-Apr-93	72	60,341	1095	0.0181	0.808137	48,764	0.1348	6,573	45	0.0068	
6-1-14-3-10	Georgiana Sl	14-Apr-93	63	53,857	204	0.0038	0.168683	9,085	0.1345	1,222	7	0.0057	
6-1-14-3-9	Ryde	14-Apr-93	61	53,265	523	0.0098	0.437263	23,291	0.1365	3,179	23	0.0072	
6-1-14-3-11	Miller Park	23-Apr-93	68	54,454	764	0.0140	0.624809	34,023	0.1361	4,631	36	0.0078	
6-1-14-11-3	Rio Vista	26-Apr-93	69	28,056	326	0.0116	0.517458	14,518	0.1299	1,886	19	0.0101	
5-1-1-8-3 to 5	Battle Creek	26-Apr-93	72	183,957	3,441	0.0187	0.833013	153,239	0.1349	20,672	130	0.0063	
6-1-14-3-13	Miller Park	03-May-93	71	51,574	687	0.0133	0.593211	30,594	0.1334	4,081	23	0.0056	
6-31-36	Georgiana Sl.	10-May-93	75	51,560	350	0.0068	0.302300	15,587	0.1327	2,068	15	0.0073	
6-1-14-3-6	Mossdale	06-Apr-93	59	50,016	37	0.0007	0.032944	1,648	0.1360	224	2	0.0089	
6-1-14-3-12	Mossdale	28-Apr-93	71	55,742	92	0.0017	0.073500	4,097	0.1389	569	4	0.0070	
6-31-35	Mossdale	04-May-93	72	51,937	111	0.0021	0.095176	4,943	0.1389	687	4	0.0058	
6-31-38	Mossdale	12-May-93	75	52,616	89	0.0017	0.075328	3,963	0.1389	551	4	0.0073	
6-63-41 & 42	New Hope Landing	06-May-93	78	100,443	600	0.0060	0.266020	26,720	0.1327	3,546	15	0.0042	
6-63-43 & 44	New Hope	20-May-93	87	99,262	779	0.0078	0.349493	34,691	0.1186	4,114	10	0.0024	

Landing													
6-31-39	Miller Park	21-May-93	80	49,786	559	0.0112	0.500021	24,894	0.1329	3,308	18	0.0054	
6-31-40	Miller Park	26-May-93	82	50,116	1,179	0.0235	1.047661	50,116	0.1386	6,946	40	0.0058	0.0065
										0.1343			
1992													
5-28-30	Benicia	28-Apr-92	80	54,055	859	0.0159							
5-28-12 to 14	Battle Creek	14-Apr-92	71	157,826	98	0.0006	0.039074	6,167	0.1368	844	21	0.0249	
5-28-18	RBDD	15-Apr-92	71	49,373	35	0.0007	0.044609	2,202	0.137	302	18	0.0597	
5-28-19	Princeton	17-Apr-92	73	53,332	154	0.0029	0.181709	9,691	0.1389	1,346	24	0.0178	
6-1-14-2-11	Ryde	06-Apr-92	77	53,630	360	0.0067	0.422413	22,654	0.1389	3,147	78	0.0248	
6-1-14-2-10	Georgiana Slough	06-Apr-92	74	51,846	144	0.0028	0.174779	9,062	0.1389	1,259	23	0.0183	
6-1-14-3-1	Ryde	14-Apr-92	82	42,534	498	0.0117	0.736777	31,338	0.1389	4,353	97	0.0223	
6-1-14-3-2	Georgiana Slough	14-Apr-92	81	52,374	240	0.0046	0.288362	15,103	0.1385	2,092	41	0.0196	
6-31-29	Ryde	27-Apr-92	81	53,099	218	0.0041	0.258353	13,718	0.1364	1,871	93	0.0497	
6-31-30	Georgiana Slough	27-Apr-92	83	51,914	34	0.0007	0.041213	2,140	0.1347	288	11	0.0382	
6-1-14-2-12 & 13	Mossdale	07-Apr-92	78	107,103	75	0.0007	0.044066	4,720	0.1389	656	20	0.0305	
6-1-14-2-14 & 15	Mossdale	13-Apr-92	82	103,712	20	0.0002	0.012135	1,259	0.1389	175	13	0.0744	
6-1-14-3-3 & 4	Mossdale	24-Apr-92	84	104,739	44	0.0004	0.026435	2,769	0.1364	378	8	0.0212	
6-31-33 & 34	Mossdale	12-May-92	86	105,385	9	0.0001	0.005374	566	0.1362	77	2	0.0259	0.0329
										0.1376			
1991													
5-1-1-1-4	Benicia	13-May-91	88	43,750	742	0.0170							
5-1-1-1-13	Battle Creek	30-Apr-91	78	64,373	273	0.0042	0.246227	15,850	0.1368	2,168	14	0.0065	
5-1-1-1-12	RBDD	01-May-91	77	64,118	375	0.0058	0.338449	21,701	0.1368	2,969	24	0.0081	
5-18-45, & 48	Princeton	03-May-91	80	51,979	173	0.0033	0.179298	9,320	0.1356	1,264	24	0.0190	

6-1-14-2-7&8	Miller Park	25-Apr-91	82	102,664	629	0.0061	0.353176	36,259	0.1389	5,036	85	0.0169	
6-1-14-2-9 6-31-24	Miller Park	29-Apr-91	80	104,516	465	0.0044	0.264931	27,690	0.1371	3,797	55	0.0145	
6-1-14-2-6	Jersey Point	19-Apr-91	82	52,139	358	0.0069	0.404850	21,108	0.1375	2,902	94	0.0324	
6-1-14-2-3 & 4	Empire Tract	17-Apr-91	78	95,602	156	0.0016	0.096213	9,198	0.1370	1,260	54	0.0429	
6-1-14-1-14 & 15	Dos Reis	15-Apr-91	80	102,999	88	0.0009	0.050376	5,189	0.1374	713	17	0.0238	
6-1-14-2-1&2	B u c k l e y Cove	16-Apr-91	79	99,341	116	0.0012	0.053838	5,348	0.1368	732	26	0.0355	
6-31-25 & 26	B u c k l e y Cove	09-May-91	85	99,820	105	0.0011	0.062022	6,191	0.1368	847	20	0.0236	
6-31-28	Jersey Point	13-May-91	87	49,184	275	0.0056	0.344396	16,939	0.1389	2,353	89	0.0378	
6-31-27	L o w e r Mokelumne	09-May-91	84	45,706	229	0.0050	0.269394	12,313	0.1378	1,697	31	0.0183	
6-1-14-2-5	L o w e r Mokelumne	18-Apr-91	79	47,289	143	0.0030	0.178299	8,432	0.1389	1,171	79	0.0675	0.02667
									0.12688				
1990													
5-20-58	Benicia	22-May-90	84	52,446	243	0.0046							
5-20-55	Battle Creek	11-May-90	83	51,069	39	0.0008	0.164821	8,417	0.1073	903	7	0.0078	
5-20-56	Red Bluff	12-May-90	82	51,533	33	0.0006	0.138208	7,122	0.0982	700	3	0.0043	
5-20-57	Princeton	14-May-90	84	52,077	12	0.0002	0.049733	2,590	0.1389	360	5	0.0139	
6-31-18	Miller Park	07-May-90	74	48,390	115	0.0024	0.512918	24,820	0.1351	3,353	43	0.0128	
6-31-20	Ryde	09-May-90	79	51,878	173	0.0033	0.719729	37,338	0.1347	5,030	87	0.0173	
6-31-21	Steamboat Slough	30-May-90	86	52,010	318	0.0061		Unusually high recovery rate - not used in calculation					
6-31-23	Sutter Slough	29-May-90	83	49,324	221	0.0045	0.967030	47,698	0.1369	6,530	39	0.0060	
6-31-22	Ryde	31-May-90	84	50,837	218	0.0043	0.925513	47,050	0.1375	6,469	67	0.0104	
6-1-14-1- 10&11	Dos Reis	02-May-90	74	103,533	34	0.0003	0.070877	7,338	0.1389	1,019	4	0.0039	

6 - 1 - 1 4 - 1,12&13	Upper River	Old	03-May-90	77	103,595	11	0.0001	0.022917	2,374	0.1389	330	1	0.0030
6-31-19	Jersey Point		04-May-90	77	50,143	208	0.0041	0.895280	44,892	0.1271	5,705	56	0.0098
6 - 1 - 1 1 - 1 4&15	Upper Tuolumne		30-Apr-90	83	93,653	18	0.0002	0.041482	3,885	0.1343	522	4	0.0077
6-1-11-2-1&2													
6-1-14-1-5 & 6	Upper River	Old	17-Apr-90	72	106,267	14	0.0001	0.028434	3,022	0.1163	351	2	0.0057
6-1-14-1-9	Jersey Point		18-Apr-90	71	52,962	224	0.0042	0.912830	48,345	0.1296	6,266	32	0.0051
6-1-14-1-7 & 8	Dos Reis		16-Apr-90	72	105,742	23	0.0002	0.046945	4,964	0.1285	638	4	0.0063
6-1-11-2-3 to 5	Lower Tuolumne		01-May-90	72	80,235	18	0.0002	0.048419	3,885	0.1389	540	1	0.0019
										0.13098			
1989													
6-1-14-1-4	Port Chicago		19-Jun-89	92	48,329	352	0.0073						
5-20-37	Battle Creek		08-May-89	69	51,074	83	0.0016	0.223122	11,396	0.1261	1,438	13	0.0090
5-20-38	RBDD		09-May-89	70	52,677	92	0.0017	0.239790	12,631	0.1267	1,600	18	0.0112
5-20-39	Princeton		10-May-89	72	50,842	90	0.0018	0.243044	12,357	0.1124	1,389	27	0.0194
6-31-11	Courtland		02-May-89	87	51,211	246	0.0048	0.659534	33,775	0.1383	4,671	46	0.0098
6-31-12	Ryde		03-May-89	86	51,046	417	0.0082	1.121604	Unusually high recovery rate - not used in calculation				
6-31-10	Miller Park		01-Jun-89	88	52,612	80	0.0015	0.208771	10,984	0.1389	1,526	9	0.0059
6-31-8	Courtland		02-Jun-89	92	50,659	41	0.0008	0.111120	5,629	0.1389	782	19	0.0243
6-31-7	Ryde		02-Jun-89	88	50,601	82	0.0016	0.222495	11,258	0.1389	1,564	26	0.0166
6-31-15&17	Miller Park		14-Jun-89	89	94,604	68	0.0007	0.098688	9,336	0.1235	1,153	20	0.0174
6-1-14-1-3 & 6-58-5	Courtland		15-Jun-89	91	90,720	84	0.0009	0.127128	11,533	0.1389	1,602	21	0.0131
6-1-14-1-1	Steamboat Slough		13-Jun-89	88	51,237	71	0.0014	0.190257	9,748	0.1389	1,354	50	0.0369
6-31-16	Sutter Slough		13-Jun-89	90	49,762	151	0.0030	0.416624	20,732	0.1331	2,759	57	0.0207
6-1-14-1-2	Ryde		16-Jun-89	89	51,134	10	0.0002	0.026851	1,373	0.1285	176	8	0.0454

6-31-14	Dos Reis	20-Apr-89	85	52,962	34	0.0006	0.088141	4,668	0.1389	648	8	0.0123	
6-31-13	Upper Old River	21-Apr-89	81	51,972	38	0.0007	0.100387	5,217	0.1389	725	5	0.0069	
6 - 1 - 1 1 - 1 - 11&12	Jersey Point	24-Jun-89	70	56,816	180	0.0032	0.434978	24,714	0.1385	3,422	53	0.0155	
6 - 1 - 1 1 - 1 - 7&8&13	Dos Reis	02-May-89	70	76,073	78	0.0010	0.140776	10,709	0.1265	1,355	11	0.0081	
6-1-11-1-4 to 6	Upper Old River	03-May-89	70	74,341	16	0.0002	0.029550	2,197	0.1380	303	4	0.0132	
B6-14-9&10	U p p e r Stanislaus	20-Apr-89	78	103,951	33	0.0003	0.043586	4,531	0.1385	628	7	0.0112	
B6-1-1	L o w e r Stanislaus	19-Apr-89	76	74,220	59	0.0008	0.109143	8,101	0.1389	1,125	17	0.0151	0.01643
B6-14-11									0.13375				
1988													
6-31-2	Ryde	07-May-88	88	53,238	1,323	0.0249	1.841257	53,238	0.2778	14,790	145	0.0098	
B6-14-8	Port Chicago	11&17-May-88	86	106,916	1,443	0.0135							Ryde used as control instead of Port Chicago or Benicia
5-18-42	Benicia												
6-31-4	Port Chicago	29-Jun-88	91	54,151	1,031	0.0190							Ryde used as control instead of Port Chicago or Benicia
5-19-39	Battle Creek	09-May-88	84	51,923	396	0.0076	0.565082	29,341	0.2741	8,042	45	0.0056	
5-19-40	RBDD	10-May-88	84	52,796	467	0.0088	0.655379	34,601	0.2741	9,484	37	0.0039	
5-19-41	Princeton	11-May-88	85	52,771	413	0.0078	0.579871	30,600	0.2724	8,336	43	0.0052	
B6-14-2&3	Courtland	03-May-88	76	107,249	1,188	0.0111	0.820729	88,022	0.2747	24,177	154	0.0064	
6-31-1	Ryde	04-May-88	86	52,741	1,076	0.0204	1.001532	52,741	0.2789	14,711	104	0.0071	
B6-14-6&7	Miller Park	05-May-88	78	102,736	1,096	0.0107	0.790432	81,206	0.2747	22,310	140	0.0063	
B6-14-4&5	Courtland	06-May-88	78	102,480	936	0.0091	0.676726	69,351	0.2538	17,603	147	0.0084	
6-62-59&60	Courtland	21-Jun-88	87	106,901	1,037	0.0097	0.718743	76,834	0.2778	21,343	39	0.0018	
6-62-63	Ryde	22-Jun-88	84	53,961	252	0.0047	0.346017	18,671	0.2778	5,187	46	0.0089	
6-62-61&62	Miller Park	23-Jun-88	89	97,892	141	0.0014	0.106721	10,447	0.2389	2,496	15	0.0060	

6-62-50	Courtland	24-Jun-88	74	99,827	70	0.0007	0.051955	5,187	0.2778	1,441	5	0.0035
6-31-5&6	Steamboat Slough	24-Jun-88	88	97,317	390	0.0040	0.296929	28,896	0.2778	8,027	79	0.0098
6-31-3	Ryde	25-Jun-88	88	53,942	285	0.0053	0.391466	21,116	0.2778	5,866	39	0.0066
B6-11-5&6	U p p e r Stanislaus	26-Apr-88	78	71,675	98	0.0014	0.101306	7,261	0.2782	2,020	11	0.0054
B6-11-3&4	L o w e r Stanislaus	26-Apr-88	79	68,788	267	0.0039	0.287591	19,783	0.2691	5,323	13	0.0024 0.00582

1987

No control release in 1987.

1986

6-62-51	Port Chicago	02-Jun-86	75	47,995	1,382	0.0288						
6-46-54 & 55	U p p e r Tuolumne	14-Apr-86	81	99,148	1,946	0.0196	0.681627072	67,582	0.1142	7,718	35	0.0045
6-46-48 to 50 & 53	U p p e r Stanislaus	28-Apr-86	86	108,273	1,457	0.0135	0.467333953	50,600	0.1292	6,537	37	0.0057
6-46-56 & 57	L o w e r Tuolumne	14-Apr-86	81	103,474	2,059	0.0199	0.691055713	71,506	0.0918	6,564	20	0.0030
6-46-45 & 46	L o w e r Stanislaus	29-Apr-86	89	106,099	2,149	0.0203	0.703417353	74,632	0.1381	10,307	60	0.0058
H5-4-2&3	Battle Creek	13-May-86	87	53,592	650	0.0121	0.421213	22,574	0.1389	3,135	30	0.0096
H5-4-4&5	RBDD	13-May-86	87	54,506	808	0.0148	0.514820	28,061	0.1389	3,897	26	0.0067
H5-4-6&7	Princeton	14-May-86	86	46,388	1,015	0.0219	0.759886	35,250	0.1389	4,896	10	0.0020
6-62-43	Courtland	27-May-86	81	98,866	1,692	0.0171	0.594349	58,761	0.1388	8,154	39	0.0048
6-62-48	Ryde	30-May-86	81	101,320	1,979	0.0195	0.678326	68,728	0.1388	9,538	74	0.0078
6-62-49	Lower Old River	31-May-86	78	98,869	645	0.0065	0.226562	22,400	0.1387	3,108	26	0.0084
6-62-47	N . F o r k Mokelumne	29-May-86	74	101,949	1,306	0.0128	0.444885	45,356	0.1135	5,147	33	0.0064
6-62-46	S . F o r k Mokelumne	30-May-86	77	102,965	984	0.0096	0.331889	34,173	0.1149	3,926	24	0.0061

6-46-58 B6-11-1	Dos Reis	29-May-86	96	95,595	2,068	0.0216	0.751283	71,819	0.1387	9,961	35	0.0035	
6-46-59 B6-11-2	U. Old River	30-May-86	92	100,181	1,139	0.0114	0.394845	39,556	0.1387	5,485	21	0.0038	0.00591
1985													
6-62-45	Port Chicago	13-May-85	78	48,143	465	0.0097							
5-39-4 5-40-4 5-41-4 H5-1-5 5-6-16	Battle Creek	14-May-85	86	65,279	65	0.0010	0.103091	6,730	0.1389	935	13	0.0139	
5-9-47 5-42-4 5-43-4 H5-1-6	RBDD	14-May-85	88	65,615	126	0.0019	0.198814	13,045	0.1389	1,812	21	0.0116	
5-9-48&49 H5-1-7	Princeton	15-May-95	89	65,922	173	0.0026	0.271704	17,911	0.1389	2,488	10	0.0040	
6-62-38 to 41	Courtland	10-May-85	81	100,626	387	0.0038	0.398181	40,067	0.1389	5,565	37	0.0066	
6-62-42	Lower Old River	08-May-85	84	105,289	232	0.0022	0.228131	24,020	0.1389	3,336	20	0.0060	
6-62-35	Ryde	11-May-85	81	107,161	924	0.0086	0.892720	95,665	0.1389	13,287	88	0.0066	
6-62-34	S . F o r k Mokelumne	07-May-85	79	100,386	317	0.0032	0.326939	32,820	0.1389	4,558	25	0.0055	
6-62-36	N . F o r k Mokelumne	09-May-85	79	101,236	565	0.0056	0.577821	58,496	0.1389	8,124	30	0.0037	0.00725
1984													
6-62-31 & 37	Port Chicago	29-Jun-84	82	42,000	315	0.0075							
6-62-27	Courtland	11-Jun-84	82	62,604	400	0.0064	0.851916	53,333	0.1093	5,827	37	0.0063	
6-62-29 6-42-9	Ryde	13-Jun-84	77	59,998	267	0.0045	0.593353	35,600	0.1122	3,994	38	0.0095	
6-62-33	Lower Old River	15-Jun-84	73	64,896	40	0.0006	0.082183	5,333	0.1128	602	9	0.0150	
6-62-28 6-42-8	S . F o r k Mokelumne	12-Jun-84	80	56,287	350	0.0062	0.829084	46,667	0.1086	5,067	33	0.0065	

6-60-40 & 41	Below RBDD	02-Jun-84	90	102,869	2,207	0.0215	2.860596	Unusually high recovery rate - not used in calculation					
6-60-42 & 43	Battle Creek	09-May-84	90	100,221	1,770	0.0177	2.354796	Unusually high recovery rate - not used in calculation					
6-60-38 & 39	K n i g h t s Landing	09-May-84	90	98,751	1,955	0.0198	2.639636	Unusually high recovery rate - not used in calculation					
6-62-32	N . F o r k Mokelumne	14-Jun-84	77	59,808	266	0.0044	0.593009	35,467	0.0933	3,308	24	0.0073	
6-48-22&23	Thornton	22-Jun-84	77	95,000	78	0.0008	0.109474	10,400	0.1306	1,358	16	0.0118	0.00939
1983													
6-62-30	Port Chicago	23-May-83	82	43,374	129	0.0030							
6-60-36 & 37	Battle Creek	02-Jun-83	76	87,890	168	0.0019	0.642702	56,487	0.0676	3,819	25	0.0065	
6-60-32 & 33	K n i g h t s Landing	02-Jun-83	74	92,085	128	0.0014	0.467370	43,038	0.0798	3,434	76	0.0221	
6-60-34 & 35	Below RBDD	02-Jun-83	76	89,841	92	0.0010	0.344313	30,933	0.0719	2,224	26	0.0117	
6-62-24	Courtland	16-May-93	78	96,706	428	0.0044	1.488093	Unusually high recovery rate - not used in calculation					
6-62-23	Isleton	20-May-83	81	92,693	368	0.0040	1.334875	Unusually high recovery rate - not used in calculation					
6-62-25	L o w e r Mokelumne	17-May-83	79	83,435	270	0.0032	1.088066	Unusually high recovery rate - not used in calculation					
6-62-26	Lower Old River	17-May-83	80	89,500	99	0.0011	0.371922	33,287	0.0962	3,202	23	0.0072	0.00718
1982													
6-62-19	Port Chicago	17-May-82	83	86,877	782	0.0090							
6-60-26 & 27	Battle Creek	05-Jun-82	80	84,702	750	0.0089	0.983707	83,322	0.0678	5,649	64	0.0113	
6-60-28 & 29	Below RBDD	05-May-82	82	88,125	729	0.0083	0.919023	80,989	0.0815	6,601	69	0.0105	
6-60-30 & 31	K n i g h t s Landing	05-May-82	81	89,275	699	0.0078	0.869852	77,656	0.0981	7,618	91	0.0119	
6-62-20	Discovery Park	11-May-82	76	85,885	1,282	0.0149	1.658322	Unusually high recovery rate - not used in calculation					
6-62-18	Discovery Park	12-May-82	83	89,780	1,085	0.0121	1.342605	Unusually high recovery rate - not used in calculation					
6-62-21	Discovery Park	04-Jun-82	76	60,822	392	0.0064	0.716017	43,550	0.1173	5,108	30	0.0059	

6-46-28	Dos Reis	24-Apr-82	67	48,227	552	0.0114	1.271589		Unusually high recovery rate - not used in calculation				
6-46-17	U. Merced River	22-Apr-82	68	49,217	428	0.0087	0.966110	47,549	0.0806	3,830	19	0.0050	0.00496
1981													
6-62-15	Port Chicago	08-Jun-81	90	78,339	2,196	0.0280							
5-5-58	C a y o t e Creek	08-May-81	82	11,031	155	0.0141	0.501259	5,529	0.1389	768	1	0.0013	
5-5-57	C a y o t e Creek	13-May-81	86	10,823	177	0.0164	0.583407	6,314	0.1389	877	3	0.0034	
6-60-20	K n i g h t s Landing	18-Jun-81	77	43,059	175	0.0041	0.144984	6,243	0.1111	694	3	0.0043	
6-60-21	K n i g h t s Landing	18-Jun-81	77	43,562	246	0.0056	0.201453	8,776	0.0417	366	2	0.0055	
6-60-16	Battle Creek	18-May-81	80	86,213	281	0.0033	0.116273	10,024	0.0833	835	5	0.0060	
6-60-17	RBDD	18-May-81	79	84,967	394	0.0046	0.165421	14,055	0.0833	1,171	8	0.0068	
6-62-14&17	Discovery Park	04-Jun-81	90	140,250	47	0.0003	0.011955	1,677	0.1111	186	1	0.0054	
6-58-23	Rio Vista	02-Jun-81	84	8,864	219	0.0247	0.881374	7,812	0.1194	933	9	0.0096	0.00696
1980													
6-62-9 & 12	Port Chicago	10 & 13-Jun-80	92	168,143	3,669	0.0218							
6-62-7	Feather R. Hatchery	03-Jun-80	91	88,335	292	0.0033	0.151489	13,382	0.1356	1,814	15	0.0083	
6-62-8	Discovery Park	03-Jun-80	88	98,586	951	0.0096	0.442075	43,582	0.1362	5,936	34	0.0057	
6-62-10	Feather R. Hatchery	05-Jun-80	90	88,516	497	0.0056	0.257315	22,777	0.1374	3,129	15	0.0048	
6-62-11	Discovery Park	05-Jun-80	90	84,643	678	0.0080	0.367088	31,071	0.1361	4,228	33	0.0078	0.00665

Appendix 2. Chippis Island tag summary, survival calculations, expanded fish facility recoveries, and expanded ocean recoveries updated through 1997 for coded wire tagged fish recovered 1978-1998.
 No ocean recoveries are reported for 1996 and 1998.
 Revised November 26, 2001

TAG CODE	RELEASE SITE/STOCK	DATE	TRUCK TEMP	RELEASE TEMP	NUMBER RELEASED	AVERAGE SIZE (MM)	FIRST DAY RECOVERED	LAST DAY RECOVERED	NUMBER RECOVERED	MINUTES FISHED	PERCENT SAMPLED	SURVIVAL INDEX	GROUP SURVIVAL	EXPANDED		EXPANDED
														SALVAGE CVP	NUMBERS SWP	OCEAN RECOVERIES
1998																
<u>Late-fall run releases</u>																
Upper Sacramento River and Tributaries																
5-50-40	Battle Creek (CNFH)		N/A	N/A	66,316	118	26-Nov-97	16-Dec-97	12	2820	0.0933	0.25		12	38	
5-50-41	Battle Creek (CNFH)		N/A	N/A	67,659	120	3-Dec-97	9-Mar-98	10	12348	0.0884	0.22		24	26	
	Total	10-Nov-97			133,975		26-Nov-97	9-Mar-98	22	12488	0.0834		0.26			
5-50-42	Battle Creek (CNFH)		N/A	N/A	59,006	134	20-Dec-97	16-Mar-98	17	9628	0.0769	0.49		48	72	
5-50-48	Battle Creek (CNFH)		N/A	N/A	66,244	134	23-Dec-97	16-Mar-98	17	9228	0.0763	0.44		60	70	
	Total	9-Dec-97			125,250		20-Dec-97	16-Mar-98	34	9648	0.0770		0.46			
5-50-59	Battle Creek (CNFH)	12-Jan-98	N/A	N/A	61,048	137	18-Jan-98	18-Mar-98	26	6415	0.0742	0.75		12	0	
5-50-51	Battle Creek (CNFH)		N/A	N/A	63,010	141	19-Jan-98	11-Mar-98	17	5615	0.0750	0.47		0	0	
5-50-52	Battle Creek (CNFH)		N/A	N/A	63,872	137	20-Jan-98	9-Mar-98	26	5235	0.0742	0.71		0	0	
5-50-53	Battle Creek (CNFH)		N/A	N/A	61,656	139	20-Jan-98	16-Mar-98	20	5815	0.0721	0.58		0	0	
	Total	13-Jan-98			188,538		19-Jan-98	16-Mar-98	63	6015	0.0733		0.59			
5-50-54	Battle Creek (CNFH)		N/A	N/A	67,408	137	20-Jan-98	16-Mar-98	15	5815	0.0721	0.40		12	0	
5-50-55	Battle Creek (CNFH)		N/A	N/A	62,350	140	22-Jan-98	12-Mar-98	22	5215	0.0724	0.63		0	0	
5-50-56	Battle Creek (CNFH)		N/A	N/A	59,002	140	21-Jan-98	12-Mar-98	17	5415	0.0737	0.51		24	0	
	Total	14-Jan-98			188,760		20-Jan-98	16-Mar-98	54	5815	0.0721		0.52			

5-50-57	Battle Creek (CNFH)		N/A	N/A	57,045	138	27-Jan-98	18-Mar-98	18	4715	0.0642	0.64	24	0
5-50-58	Battle Creek (CNFH)		N/A	N/A	60,144	141	28-Jan-98	18-Mar-98	13	4515	0.0627	0.45	12	0
	Total	22-Jan-98			117,189		27-Jan-98	18-Mar-98	31	4715	0.0642	0.54		

Sacramento-San Joaquin Estuary

5-50-50	Georgiana Slough (CNFH)	12/04/97	54	52	61,276	127	17-Jan-98	1-Feb-98	2	3100	0.1345	0.03	52	101
5-50-60	Ryde (CNFH)	12/04/97	54	52	46,756	123	11-Dec-97	14-Jan-98	22	4573	0.0907	0.67	0	18
5-50-49	Georgiana Slough (CNFH)	01/13/98	52	50	66,893	140	18-Jan-98	3-Feb-98	18	3300	0.1348	0.26	24	0
5-50-62	Ryde (CNFH)	01/13/98	52	50	49,059	142	16-Jan-98	1-Feb-98	48	3280	0.1340	0.95	0	0
5-50-61	Port Chicago (CNFH)	29-Dec-97	52	48	48,080	127	3-Jan-98	9-Jan-98	5	-	-		0	0

Fall run releases

Upper Sacramento River and Tributaries

6-1-6-4-5	Feather River (DWRRO)	25-Jan-98	N/A	N/A	13,595	37	20-Apr-98	9-May-98	4	7580	0.2632	0.15	0	0
6-1-6-4-7	Feather River (DWRRO)	22-Feb-98	N/A	N/A	10,840	37	19-May-98	15-Jun-98	5	7167	0.1778	0.34	0	0
5-1-2-5-8	Battle Creek (CNFH)		N/A	N/A	37,880	58	13-Apr-98	15-May-98	7	11875	0.2499	0.10	0	0
5-1-2-5-9	Battle Creek (CNFH)		N/A	N/A	37,595	59	16-Apr-98	7-May-98	12	8380	0.2645	0.16	0	0
5-1-2-5-13	Battle Creek (CNFH)		N/A	N/A	36,701	53	16-Apr-98	25-Apr-98	5	3780	0.2625	0.07	0	0
	Total	4-Mar-98			112,176		13-Apr-98	15-May-98	24	11875	0.2499	0.11		
5-1-2-5-10	Battle Creek (CNFH)		N/A	N/A	37,883	58	15-Apr-98	7-May-98	13	8580	0.2591	0.17	0	0
5-1-2-5-11	Battle Creek (CNFH)		N/A	N/A	37,766	59	27-Mar-98	11-May-98	10	11500	0.1736	0.20	0	0

5-1-2-5-12	Battle Creek (CNFH)		N/A	N/A	29,708	56	25-Mar-98	1-May-98	10	7870	0.1438	0.30	0	0
	Total	6-Mar-98			105,357		25-Mar-98	11-May-98	33	11690	0.1691		0.24	
6-1-6-4-9	Feather River (DWRRO)	6-Mar-98	N/A	N/A	12,573	37	22-May-98	12-Jun-98	3	5592	0.1765	0.18	0	0
5-1-2-5-14	Battle Creek (CNFH)		N/A	N/A	36,432	68	18-Apr-98	14-May-98	23	10320	0.2654	0.31	0	0
5-1-2-5-15	Battle Creek (CNFH)		N/A	N/A	37,374	64	20-Apr-98	22-May-98	14	12545	0.2640	0.18	0	0
5-1-2-6-1	Battle Creek (CNFH)		N/A	N/A	37,441	64	16-Apr-98	21-May-98	23	13790	0.2660	0.30	0	0
5-1-2-6-2	Battle Creek (CNFH)		N/A	N/A	37,369	65	19-Apr-98	3-Jun-98	31	11435	0.1726	0.62	0	0
5-1-2-6-3	Battle Creek (CNFH)		N/A	N/A	36,631	66	17-Apr-98	14-May-98	20	10280	0.2550	0.28	0	0
5-1-2-6-4	Battle Creek (CNFH)		N/A	N/A	37,403	65	18-Apr-98	22-May-98	24	13325	0.2644	0.32	0	0
5-1-2-6-5	Battle Creek (CNFH)		N/A	N/A	37,769	61	16-Apr-98	29-May-98	14	11815	0.1865	0.26	0	0
5-1-2-6-6	Battle Creek (CNFH)		N/A	N/A	37,126	62	23-Apr-98	14-May-98	13	8835	0.2789	0.16	0	0
	Total	31-Mar-98			297,545		16-Apr-98	3-Jun-98	162	17782	0.2520		0.28	
5-1-2-6-7	Battle Creek (CNFH)		N/A	N/A	37,519	65	19-Apr-98	13-May-98	20	9520	0.2644	0.26	0	0
5-1-2-6-8	Battle Creek (CNFH)		N/A	N/A	37,217	66	20-Apr-98	19-May-98	25	11435	0.2647	0.33	0	0
5-1-2-6-9	Battle Creek (CNFH)		N/A	N/A	37,154	64	20-Apr-98	18-May-98	27	11055	0.2647	0.36	0	0
5-1-2-7-4	Battle Creek (CNFH)		N/A	N/A	37,404	55	3-May-98	29-May-98	15	10322	0.2655	0.20	0	0
	Total	7-Apr-98			149,294		19-Apr-98	29-May-98	87	15662	0.2653		0.29	
5-1-1-15-12	Caldwell Park (LSFH)	9-Apr-98	N/A	N/A	21,271	78	20-Apr-98	6-May-98	15	6440	0.2631	0.35	0	0
5-1-2-6-10	Battle Creek (CNFH)	22-Apr-98	N/A	N/A	37,091	72	29-Apr-98	28-May-98	31	11442	0.2649	0.41	0	0
5-1-2-6-11	Battle Creek (CNFH)	22-Apr-98	N/A	N/A	36,291	73	29-Apr-98	24-May-98	39	9925	0.2651	0.53	0	0
5-1-2-6-12	Battle Creek (CNFH)	22-Apr-98	N/A	N/A	37,612	72	28-Apr-98	29-May-98	45	12242	0.2657	0.59	0	0
5-1-2-6-13	Battle Creek (CNFH)	22-Apr-98	N/A	N/A	37,740	71	29-Apr-98	28-May-98	41	11442	0.2649	0.53	0	0
5-1-2-6-14	Battle Creek (CNFH)	22-Apr-98	N/A	N/A	37,489	70	29-Apr-98	31-May-98	47	12442	0.2618	0.62	0	0
5-1-2-6-15	Battle Creek (CNFH)	22-Apr-98	N/A	N/A	37,825	68	30-Apr-98	30-May-98	47	11842	0.2653	0.61	0	0
5-1-2-7-1	Battle Creek (CNFH)	22-Apr-98	N/A	N/A	37,669	69	30-Apr-98	30-May-98	40	11842	0.2653	0.52	0	0
5-1-2-7-2	Battle Creek (CNFH)	22-Apr-98	N/A	N/A	37,812	67	29-Apr-98	3-Jun-98	46	12802	0.2470	0.64	0	0

5-1-2-7-3	Battle Creek (CNFH)	23-Apr-98	N/A	N/A	37,217	66	1-May-98	30-May-98	38	11502	0.2663	0.50	0	0
5-1-2-7-5	Battle Creek (CNFH)	23-Apr-98	N/A	N/A	37,551	57	3-May-98	3-Jun-98	15	11282	0.2448	0.21	0	0
	Total				374,297		28-Apr-98	3-Jun-98	389	13202	0.2478	0.55		
6-1-6-6-14	Gridley (FRH)		N/A	N/A	43,519	78	3-May-98	8-Jun-98	45	12242	0.2298	0.59	0	0
6-1-6-6-15	Gridley (FRH)		N/A	N/A	41,231	78	4-May-98	1-Jun-98	49	10622	0.2544	0.61	0	0
	Total	30-Apr-98			84,750		3-May-98	8-Jun-98	94	12242	0.2298	0.63		
Sacramento-San Joaquin Estuary														
6-1-13-1-14	Woodbridge Dam (MOK)	1-Mar-98	N/A	N/A	11,278	59	17-Apr-98	31-May-98	13	17022	0.2627	0.57	0	0
6-1-6-4-10	Fremont Weir (FRH)		N/A	N/A	25,835	69	1-Apr-98	16-Apr-98	2	1580	0.0686	0.15	0	0
6-1-6-4-11	Fremont Weir (FRH)		N/A	N/A	25,708	69	15-Apr-98	26-Apr-98	7	4380	0.2535	0.14	0	0
	Total	2-Mar-98			51,543		1-Apr-98	26-Apr-98	9	5360	0.1432	0.16		
6-1-6-4-12	Elkhorn Sl. Boat Ramp (FRH)		N/A	N/A	25,701	67	17-Apr-98	15-May-98	4	11075	0.2652	0.08	0	0
6-1-6-4-13	Elkhorn Sl. Boat Ramp (FRH)		N/A	N/A	27,027	67	17-Apr-98	12-May-98	6	9920	0.2650	0.11	0	0
	Total	2-Mar-98			52,728		17-Apr-98	15-May-98	10	11075	0.2652	0.09		
6-1-6-5-7	West Sacramento (FRH)		51	54	21,402	83	19-Apr-98	15-May-98	32	10315	0.2653	0.73	0	0
6-1-6-5-8	West Sacramento (FRH)		51	54	21,691	83	17-Apr-98	9-May-98	26	8740	0.2639	0.59	0	0
	Total	15-Apr-98			43,093		17-Apr-98	15-May-98	58	11075	0.2652	0.66		
6-1-11-8-9	Mosssdale (MRFF)	16-Apr-98	54	57	26,465	86	21-Apr-98	2-May-98	25	4540	0.2627	0.47	12	0
6-1-11-8-10	Mosssdale (MRFF)	16-Apr-98	54	57	25,264	86	20-Apr-98	2-May-98	31	4940	0.2639	0.60	24	0
6-1-11-8-11	Mosssdale (MRFF)	16-Apr-98	54	57	25,926	86	20-Apr-98	1-May-98	32	4540	0.2627	0.61	12	0
	Total				77,655		20-Apr-98	2-May-98	88	4940	0.2639	0.56		
6-1-11-8-6	Dos Reis		54	59	26,215	86	21-Apr-98	1-May-98	34	4140	0.2614	0.65	0	0

6-1-11-8-7	(MRH) Dos Reis (MRH)	54	59	26,366	86	21-Apr-98	1-May-98	25	4140	0.2614	0.47	0	0	
6-1-11-8-8	Dos Reis (MRH)	54	59	24,792	86	20-Apr-98	29-Apr-98	34	3820	0.2653	0.67	0	0	
	Total	17-Apr-98		77,373		20-Apr-98	1-May-98	93	4540	0.2627	0.59			
6-1-11-8-12	Jersey Point (MRH)	58	62	24,598	89	21-Apr-98	3-May-98	87	4920	0.2628	1.75	0	0	
6-1-11-8-13	Jersey Point (MRH)	58	62	25,673	89	21-Apr-98	1-May-98	100	4140	0.2614	1.94	0	0	
	Total	20-Apr-98		50,271		21-Apr-98	3-May-98	187	4920	0.2628	1.84			
6-1-13-1-15	Woodbridge Dam (MOK)	16-Apr-98	N/A	N/A	11,367	87	1-May-98	17-May-98	10	6495	0.2653	0.43	0	0
6-2-32	New Hope Landing (MOK)	N/A	N/A	51,107	81	26-Apr-98	17-May-98	46	8435	0.2663	0.44	0	0	
6-2-33	New Hope Landing (MOK)	N/A	N/A	51,372	77	26-Apr-98	15-May-98	30	7695	0.2672	0.28	0	0	
	Total	21-Apr-98		102,479		26-Apr-98	17-May-98	76	8435	0.2663	0.36			
6-1-6-5-5	Mossdale (FRH)	54	66	15,559	84	8-May-98	9-May-98	2	760	0.2639	0.06	72	0	
6-1-6-5-6	Mossdale (FRH)	54	66	18,400	84	25-Apr-98	16-May-98	5	8415	0.2656	0.13	120	0	
	Total	23-Apr-98		33,959		25-Apr-98	16-May-98	7	8415	0.2656	0.10			
6-1-14-6-6	Dos Reis (FRH)	54	65	23,849	91	2-May-98	17-May-98	8	6115	0.2654	0.16	0	0	
6-1-14-6-7	Dos Reis (FRH)	54	65	24,252	91	1-May-98	13-May-98	9	4960	0.2650	0.18	0	0	
	Total	24-Apr-98		48,101		1-May-98	17-May-98	17	4540	0.1855	0.25			
6-1-6-5-11	Lighthouse Marina (FRH)	58	61	21,288	89	1-May-98	24-May-98	34	9185	0.2658	0.78	0	0	
6-1-6-5-12	Lighthouse Marina (FRH)	58	61	22,821	89	1-May-98	13-May-98	27	4960	0.2650	0.58	0	0	
	Total	27-Apr-98		44,109		1-May-98	24-May-98	61	9185	0.2658	0.68			
6-1-6-5-3	Jersey Point (FRH)	59	66	15,139	78	3-May-98	21-May-98	14	7290	0.2664	0.45	0	0	
6-1-6-5-4	Jersey Point (FRH)	59	66	15,781	78	30-Apr-98	12-May-98	26	4940	0.2639	0.81	0	0	
	Total	28-Apr-98		30,920		30-Apr-98	21-May-98	40	8410	0.2655	0.63			

6-2-34	Jersey Point (MOK)	28-Apr-98	N/A	N/A	51,228	86	29-Apr-98	14-May-98	110	6100	0.2648	1.05	0	0
6-2-35	Jersey Point (MOK)	28-Apr-98	N/A	N/A	52,128	84	29-Apr-98	18-May-98	105	7635	0.2651	0.99	0	0
	Total				103,356		29-Apr-98	18-May-98	215	7635	0.2651	1.02		
6-1-6-5-13	Verona (FRH)		N/A	N/A	38,955	78	5-May-98	30-May-98	38	10022	0.2677	0.47	0	0
6-1-6-5-14	Verona (FRH)		N/A	N/A	39,300	78	5-May-98	6-Jun-98	45	11182	0.2353	0.63	0	0
	Total	30-Apr-98			78,255		5-May-98	6-Jun-98	83	11182	0.2353	0.59		
6-1-6-6-9	SFBay-Wickland Oil (FRH)		N/A	N/A	17,737	96	19-May-98	19-May-98	1	-	-			
6-1-6-6-10	SFBay-Wickland Oil (FRH)		N/A	N/A	18,052	96	18-May-98	18-May-98	1	-	-			
6-1-6-6-11	SFBay-Wickland Oil (FRH)		N/A	N/A	18,244	96	24-May-98	24-May-98	1	-	-			
	Total	4-May-98			54,033		18-May-98	24-May-98	3					
6-1-6-4-14	Mossdale (FRH)		51	64	21,600	90	8-May-98	26-May-98	15	7262	0.2654	0.34	372	0
6-1-6-4-15	Mossdale (FRH)		51	64	21,599	90	11-May-98	21-May-98	6	4270	0.2696	0.13	252	0
	Total	6-May-98			43,199		8-May-98	26-May-98	21	7262	0.2654	0.24		
6-1-13-2-1	Woodbridge Dam (MOK)	7-May-98	N/A	N/A	12,351	92	17-May-98	26-May-98	9	3827	0.2658	0.36	0	0
6-1-6-5-1	Benicia (FRH)		N/A	N/A	15,429	92	18-May-98	25-May-98	2	-	-		0	0
6-1-6-5-2	Benicia (FRH)		N/A	N/A	15,348	92	-	-					0	0
	Total	7-May-98			30,777		18-May-98	25-May-98	2	-	-			
6-2-38	New Hope Landing (MOK)		N/A	N/A	51,046	101	19-May-98	2-Jun-98	52	4967	0.2300	0.58	0	0
6-2-39	New Hope Landing (MOK)		N/A	N/A	51,624	101	17-May-98	7-Jun-98	63	6767	0.2136	0.74	0	0
	Total	14-May-98			102,670		17-May-98	7-Jun-98	115	6767	0.2136	0.68		
6-1-6-5-9	West Sacramento (FRH)		54	57	17,940	99	19-May-98	30-May-98	37	4607	0.2666	1.01	0	0
6-1-6-5-10	West Sacramento		54	57	16,600	99	18-May-98	26-May-98	29	3427	0.2644	0.86	0	0

	(FRH) Total	15-May-98			34,540		18-May-98	30-May-98	66	5007	0.2675		0.93		
6-1-13-2-2	Woodbridge Dam (MOK)	20-May-98	N/A	N/A	10,414	97	8-Jun-98	8-Jun-98	1	160	0.1111	0.11		0	0
Upper San Joaquin River and Tributaries															
6-25-20	Upper Merced (MRFF)		N/A	N/A	27,973	83	26-Apr-98	29-May-98	15	13042	0.2664	0.26		276	4
6-45-23	Upper Merced (MRFF)		N/A	N/A	35,800	83	26-Apr-98	30-May-98	25	13442	0.2667	0.34		224	4
6-45-24	Upper Merced (MRFF)		N/A	N/A	36,289	83	23-Apr-98	21-May-98	24	11150	0.2670	0.32		364	0
	Total	12-Apr-98			100,062		23-Apr-98	30-May-98	64	14582	0.2665		0.31		
6-25-21	Lower Merced (MRFF)		49	50	34,805	85	27-Apr-98	11-May-98	21	5740	0.2657	0.30		512	0
6-25-22	Lower Merced (MRFF)		49	50	30,857	85	23-Apr-98	12-May-98	18	7680	0.2667	0.28		280	0
6-25-23	Lower Merced (MRFF)		49	50	8,447	85	28-Apr-98	2-May-98	2	1920	0.2667	0.12		76	0
	Total	14-Apr-98			74,109		23-Apr-98	12-May-98	41	7680	0.2667		0.27		
6-1-11-7-3	Upper Tuolumne (MRFF)		50	51	32,787	83	21-Apr-98	29-May-98	28	14862	0.2646	0.42		284	6
6-1-11-7-4	Upper Tuolumne (MRFF)		50	51	26,633	83	23-Apr-98	9-May-98	5	6500	0.2655	0.09		280	0
6-1-11-7-5	Upper Tuolumne (MRFF)		50	51	27,404	83	29-Apr-98	2-Jun-98	19	12602	0.2500	0.36		312	6
6-1-11-7-6	Upper Tuolumne (MRFF)		50	51	7,234	83	13-May-98	20-May-98	2	3075	0.2669	0.13		84	10
	Total	15-Apr-98			94,058		21-Apr-98	2-Jun-98	54	15622	0.2523		0.30		
6-1-11-7-7	Downstream of Tuol. R. (MRFF)	16-Apr-98	N/A	59	25,754	86	21-Apr-98	16-May-98	18	9855	0.2632	0.35		212	0
6-1-11-7-8	Downstream of Tuol. R. (MRFF)	17-Apr-98	N/A	59	22,006	83	23-Apr-98	22-May-98	20	11465	0.2654	0.45		220	0
	Total				47,760		21-Apr-98	22-May-98	38	12145	0.2636		0.39		
6-1-11-7-9	Upper		N/A	52	28,248	85	13-May-98	4-Jun-98	8	7662	0.2313	0.16		228	6

6-1-11-7-10	Merced (MRH) Upper Merced (MRH)	N/A	52	25,482	85	18-May-98	30-May-98	6	5007	0.2675	0.11	180	0
6-1-11-7-11	Merced (MRH) Upper Merced (MRH)	N/A	52	25,220	85	25-May-98	30-May-98	5	2317	0.2682	0.10	192	30
6-1-11-7-12	Merced (MRH) Upper Merced (MRH)	N/A	52	25,046	85	15-May-98	27-May-98	10	4942	0.2640	0.20	240	18
	Total	3-May-98		103,996		13-May-98	4-Jun-98	29	7662	0.2313	0.16		
6-1-11-5-2	Lower Merced (MRH)	53	59	49,873	89	10-May-98	29-May-98	18	7682	0.2667	0.18	852	17
6-1-11-7-13	Lower Merced (MRH)	53	59	25,314	89	10-May-98	30-May-98	16	8082	0.2673	0.31	396	32
	Total	5-May-98		75,187		10-May-98	30-May-98	34	8082	0.2673	0.22		

1997

Late-fall run releases

Upper Sacramento River and Tributaries

5-42-32	Battle Creek (CNFH)	N/A	N/A	65,281	98	4-Dec-96	4-Feb-97	8	8242	0.0909	0.18	0	0
5-42-33	Battle Creek (CNFH)	N/A	N/A	62,179	118	25-Nov-96	19-Feb-97	12	10042	0.0802	0.31	0	0
	Total	7-Nov-96		127,460		25-Nov-96	19-Feb-97	20	10042	0.0802	0.25		
5-42-34	Battle Creek (CNFH)	N/A	N/A	63,276	132	15-Dec-96	28-Feb-97	19	8239	0.0753	0.52	0	0
5-42-35	Battle Creek (CNFH)	N/A	N/A	59,739	131	15-Dec-96	7-Mar-97	16	8824	0.0738	0.47	0	0
	Total	10-Dec-96		123,015		15-Dec-96	7-Mar-97	35	8824	0.0738	0.50		
5-42-36	Battle Creek (CNFH)	N/A	N/A	62,269	121	16-Jan-97	28-Mar-97	11	8064	0.0778	0.30	0	0
5-42-37	Battle Creek (CNFH)	N/A	N/A	65,279	117	15-Jan-97	4-Apr-97	17	8864	0.0769	0.44	0	0
	Total	9-Jan-97		127,548		15-Jan-97	4-Apr-97	28	8864	0.0769	0.37		
5-41-23	Battle Creek (CNFH)	N/A	N/A	64,219	147	21-Jan-97	3-Mar-97	12	5124	0.0847	0.29	0	0
5-41-24	Battle Creek (CNFH)	N/A	N/A	58,095	132	22-Jan-97	25-Mar-97	18	6689	0.0737	0.55	0	0
5-41-25	Battle Creek (CNFH)	N/A	N/A	62,760	153	21-Jan-97	26-Feb-97	17	4764	0.0894	0.39	0	0
5-41-26	Battle Creek	N/A	N/A	59,170	115	5-Feb-97	10-Apr-97	16	5505	0.0588	0.60	0	0

5-41-27	(CNFH) Battle Creek (CNFH)		N/A	N/A	60,288	114	22-Jan-97	28-Mar-97	9	6889	0.0725	0.27	0	1
5-42-41	Battle Creek (CNFH)		N/A	N/A	58,401	150	22-Jan-97	21-Feb-97	6	4184	0.0937	0.14	0	6
	Total	16-Jan-97			362,933		21-Jan-97	10-Apr-97	78	8269	0.0718	0.39		
5-42-38	Battle Creek (CNFH)		N/A	N/A	60,524	125	23-Jan-97	21-Mar-97	8	6289	0.0753	0.23	0	0
5-42-39	Battle Creek (CNFH)		N/A	N/A	61,291	149	22-Jan-97	31-Mar-97	15	7089	0.0713	0.45	0	0
5-42-40	Battle Creek (CNFH)		N/A	N/A	63,817	121	22-Jan-97	21-Mar-97	19	6489	0.0764	0.51	0	0
	Total	17-Jan-97			185,632		22-Jan-97	31-Mar-97	42	7089	0.0713	0.41		

Sacramento-San Joaquin Estuary

5-42-31	Miller Park (CNFH)	2-Dec-96	52	54	55,425	117	8-Dec-96	17-Dec-96	20	2003	0.1391	0.34	0	6
5-42-30	Miller Park (CNFH)	14-Jan-97	41	45	48,046	118	16-Jan-97	7-Feb-97	11	4359	0.1316	0.23	0	0

Fall run releases

Upper Sacramento River and Tributaries

5-1-2-2-8	Battle Creek (CNFH)		N/A	N/A	30,589	72	15-Apr-97	23-Apr-97	2	1800	0.1389	0.06	0	0
5-1-2-2-9	Battle Creek (CNFH)		N/A	N/A	32,018	73	16-Apr-97	23-Apr-97	7	1600	0.1389	0.20	0	0
5-1-2-2-10	Battle Creek (CNFH)		N/A	N/A	33,307	73	17-Apr-97	22-Apr-97	3	1200	0.1389	0.08	0	0
5-1-2-2-11	Battle Creek (CNFH)		N/A	N/A	30,962	71	22-Apr-97	3-May-97	5	2350	0.1360	0.15	0	0
5-1-2-2-12	Battle Creek (CNFH)		N/A	N/A	32,813	69	18-Apr-97	3-May-97	6	3150	0.1367	0.17	0	0
5-1-2-2-13	Battle Creek (CNFH)		N/A	N/A	28,501	70	17-Apr-97	2-May-97	8	3150	0.1367	0.27	0	0
5-1-2-2-14	Battle Creek (CNFH)		N/A	N/A	32,178	72	16-Apr-97	29-Apr-97	9	2750	0.1364	0.27	0	0
5-1-2-2-15	Battle Creek (CNFH)		N/A	N/A	34,936	69	24-Apr-97	7-May-97	5	2747	0.1363	0.14	0	0
5-1-2-3-1	Battle Creek (CNFH)		N/A	N/A	33,195	71	18-Apr-97	3-May-97	7	3150	0.1367	0.20	0	3
	Total	1-Apr-97			288,499		15-Apr-97	7-May-97	52	4547	0.1373	0.17		
5-1-2-3-9	Battle Creek (CNFH)		N/A	N/A	33,626	69	21-Apr-97	7-May-97	5	3347	0.1367	0.14	0	0
5-1-2-3-10	Battle Creek (CNFH)		N/A	N/A	31,777	67	5-May-97	8-May-97	2	797	0.1384	0.06	0	0
5-1-2-3-3	Battle Creek (CNFH)		N/A	N/A	31,826	72	21-Apr-97	28-Apr-97	4	1550	0.1345	0.12	0	0

	Total	9-Apr-97			97,229		21-Apr-97	8-May-97	11	3547	0.1368		0.11		
5-1-2-3-6	Battle Creek (CNFH)	N/A	N/A	34,492	73	26-Apr-97	18-May-97	11	4517	0.1364	0.30	0	0		
5-1-2-3-7	Battle Creek (CNFH)	N/A	N/A	34,829	73	26-Apr-97	15-May-97	12	3947	0.1370	0.33	0	0		
5-1-2-3-8	Battle Creek (CNFH)	N/A	N/A	35,473	72	29-Apr-97	4-May-97	6	1200	0.1389	0.16	0	0		
5-1-2-3-11	Battle Creek (CNFH)	N/A	N/A	35,198	68	30-Apr-97	8-May-97	4	1797	0.1387	0.11	0	0		
5-1-2-3-2	Battle Creek (CNFH)	N/A	N/A	30,618	75	26-Apr-97	1-May-97	11	1150	0.1331	0.35	0	0		
5-1-2-3-4	Battle Creek (CNFH)	N/A	N/A	31,413	73	25-Apr-97	7-May-97	4	2547	0.1361	0.12	0	0		
5-1-2-3-5	Battle Creek (CNFH)	N/A	N/A	34,516	74	26-Apr-97	30-Apr-97	6	950	0.1319	0.17	0	0		
	Total	15-Apr-97		236,539		25-Apr-97	18-May-97	54	4717	0.1365		0.22			
5-1-2-4-1	Battle Creek (CNFH)	N/A	N/A	34,417	56	24-May-97	24-May-97	1	200	0.1389	0.03	0	0		
5-1-2-4-2	Battle Creek (CNFH)	N/A	N/A	34,416	56	-	-	0	-	-		0	0		
5-1-2-3-12	Battle Creek (CNFH)	N/A	N/A	35,045	68	30-Apr-97	8-May-97	6	1797	0.1387	0.16	0	0		
5-1-2-3-13	Battle Creek (CNFH)	N/A	N/A	34,256	67	1-May-97	7-May-97	5	1397	0.1386	0.14	0	0		
5-1-2-3-14	Battle Creek (CNFH)	N/A	N/A	34,681	61	28-Apr-97	28-Apr-97	1	200	0.1389	0.03	0	0		
5-1-2-3-15	Battle Creek (CNFH)	N/A	N/A	34,680	61	30-Apr-97	11-May-97	4	2397	0.1387	0.11	0	0		
	Total	16-Apr-97		207,495		28-Apr-97	24-May-97	17	5167	0.1329		0.08			
5-1-2-4-3	Battle Creek (CNFH)	N/A	N/A	34,802	73	-	-	0	-	-		0	0		
5-1-2-4-5	Battle Creek (CNFH)	N/A	N/A	34,298	71	17-May-97	18-May-97	3	370	0.1285	0.09	12	0		
5-1-2-4-4	Battle Creek (CNFH)	N/A	N/A	35,000	73	16-May-97	4-Jun-97	2	3950	0.1372	0.05	12	0		
	Total	6-May-97		104,100		16-May-97	4-Jun-97	5	3950	0.1372		0.05			
Sacramento-San Joaquin Estuary															
6-48-6	Woodbridge (MOK)	16-Oct-96	N/A	66	42,807	161	-	-	0	-	-	12	6		
6-1-6-2-11	West Sacramento (FRH)		48	63	25,641	95	22-Apr-97	7-May-97	14	3147	0.1366	0.52	0	0	
6-1-6-2-12	West Sacramento (FRH)		48	63	25,032	95	22-Apr-97	8-May-97	9	3347	0.1367	0.34	0	0	
	Total	15-Apr-97			50,673		22-Apr-97	8-May-97	23	3347	0.1367		0.43		

6-49-10	New Hope Landing (MOK)		N/A	N/A	52,424	78	30-Apr-97	5-May-97	6	1200	0.1389	0.11	0	0
6-49-11	New Hope Landing (MOK)		N/A	N/A	51,032	76	29-Apr-97	11-May-97	10	2597	0.1387	0.18	0	0
	Total	23-Apr-97			103,456		29-Apr-97	11-May-97	16	2597	0.1387	0.14		
6-25-41	Gridley Boat Ramp (FRH)		N/A	N/A	52,669	97	4-May-97	18-May-97	18	2967	0.1374	0.32	0	0
6-25-42	Gridley Boat Ramp (FRH)		N/A	N/A	52,597	97	3-May-97	26-May-97	17	4567	0.1321	0.32	0	0
	Total	24-Apr-97			105,266		3-May-97	26-May-97	35	4567	0.1321	0.33		
6-2-31	San Pablo Bay (MOK)	24-Apr-97	N/A	N/A	52,317	86	12-May-97	12-May-97	1	-	-		0	0
6-25-43	Verona Boat Ramp (FRH)		N/A	N/A	50,757	96	30-Apr-97	11-May-97	12	2397	0.1387	0.22	0	0
6-25-44	Verona Boat Ramp (FRH)		N/A	N/A	48,561	96	29-Apr-97	12-May-97	18	2797	0.1387	0.35	0	0
	Total	24-Apr-97			99,318		29-Apr-97	12-May-97	30	2797	0.1387	0.28		
6-1-6-3-2	Mossdale (w/ barrier) (FRH)		50	60	23,701	100	3-May-97	7-May-97	2	997	0.1385	0.08	96	10
6-1-6-3-3	Mossdale (w/ barrier) (FRH)		50	60	25,073	100	5-May-97	18-May-97	8	2767	0.1373	0.30	96	24
	Total	28-Apr-97			48,774		3-May-97	18-May-97	10	3167	0.1375	0.19		
6-1-6-3-4	Dos Reis (FRH)		51	60	25,084	97	6-May-97	11-May-97	7	1197	0.1385	0.26	60	17
6-1-6-3-5	Dos Reis (FRH)		51	60	24,746	97	26-Apr-97	11-May-97	4	3147	0.1366	0.15	36	12
	Total	29-Apr-97			49,830		26-Apr-97	11-May-97	11	3147	0.1366	0.21		
6-25-45	Dos Reis (MRFF)		56	60	49,005	74	8-May-97	16-May-97	9	1800	0.1389	0.17	108	72
6-25-46	Dos Reis (MRFF)		56	60	53,475	74	10-May-97	15-May-97	7	1200	0.1389	0.12	156	58
	Total	29-Apr-97			102,480		8-May-97	16-May-97	16	1800	0.1389	0.15		
6-49-12	Jersey Point (MOK)		N/A	N/A	52,022	75	2-May-97	11-May-97	27	1997	0.1387	0.49	0	0
6-49-13	Jersey Point (MOK)		N/A	N/A	51,978	70	2-May-97	10-May-97	36	1797	0.1387	0.65	0	8
	Total	30-Apr-97			104,000		2-May-97	11-May-97	63	1997	0.1387	0.57		
6-1-6-2-13	West Sacramento (FRH)		48	64	25,829	102	5-May-97	15-May-97	15	2197	0.1387	0.54	0	0

6-1-6-2-14	West Sacramento (FRH)		48	64	26,315	102	7-May-97	10-May-97	7	800	0.1389	0.25		0	0
	Total	1-May-97			52,144		5-May-97	15-May-97	22	2197	0.1387		0.40		
6-1-6-2-7	Jersey Point (FRH)		48	63	24,815	99	3-May-97	10-May-97	27	1597	0.1386	1.02		12	0
6-1-6-2-8	Jersey Point (FRH)		48	63	25,049	99	4-May-97	11-May-97	28	1597	0.1386	1.05		0	0
	Total	2-May-97			49,864		3-May-97	11-May-97	55	1797	0.1387		1.03		
6-25-47	Jersey Point (MRFF)	2-May-97	55	64	51,588	75	4-May-97	19-May-97	27	3167	0.1375	0.50		12	12
6-1-6-3-1	Port Chicago (FRH)		58	64	23,772	99	8-May-97	10-May-97	4	-	-			0	0
6-1-6-2-15	Port Chicago (FRH)		58	64	24,766	99	8-May-97	15-May-97	6	-	-			0	0
	Total	5-May-97			48,538		8-May-97	15-May-97	10						
6-25-48	Dos Reis (MRFF)	8-May-97	57	66	46,728	75	15-May-97	22-May-97	5	1370	0.1189	0.12		24	54
6-25-49	Jersey Point (MRFF)	12-May-97	58	67	47,254	74	15-May-97	25-May-97	18	1970	0.1244	0.40		12	2
6-1-6-2-9	West Sacramento (FRH)		52	72	25,152	107	-	-	0	-	-			0	0
6-1-6-2-10	West Sacramento (FRH)		82	72	25,069	107	21-May-97	21-May-97	1	200	0.1389	0.04		0	0
	Total	15-May-97			50,221		21-May-97	21-May-97	1	200	0.1389		0.02		
6-1-6-3-6	Benicia (FRH)	19-May-97	N/A	N/A	52,345	100	28-May-97	3-Jun-97	4	-	-			0	8
6-1-6-3-7	Benicia (FRH)	19-May-97	N/A	N/A	53,261	100	29-May-97	29-May-97	2	-	-			0	0
6-1-6-3-8	Benicia (FRH)	19-May-97	N/A	N/A	52,818	100	28-May-97	30-May-97	3	-	-			0	0
6-1-6-3-9	Benicia (FRH)	19-May-97	N/A	N/A	50,672	100	29-May-97	29-May-97	2	-	-			0	0
6-1-6-3-10	Benicia (FRH)	19-May-97	N/A	N/A	52,023	100	29-May-97	4-Jun-97	3	-	-			0	0
6-1-6-3-11	Benicia (FRH)	19-May-97	N/A	N/A	53,054	100	29-May-97	5-Jun-97	7	-	-			0	0
	Total		0	0	314,173	600			21	0	0.0000				
6-25-50	Dos Reis (MRFF)	27-May-97	55	72	49,139	77	4-Jun-97	10-Jun-97	7	1130	0.1121	0.17		312	36

Upper San Joaquin River and Tributaries

6-1-11-5-11	Upper Merced (MRFF)	N/A	53	26,045	77	6-May-97	6-May-97	1	197	0.1368	0.04	0	18
6-1-11-5-12	Upper Merced (MRFF)	N/A	53	27,683	77	6-May-97	8-May-97	3	597	0.1382	0.10	24	3
6-1-11-5-13	Upper Merced (MRFF)	N/A	53	31,930	77	9-May-97	9-May-97	1	200	0.1389	0.03	36	0
6-1-11-6-12	Upper Merced (MRFF)	N/A	53	24,880	77	-	-	0	-	-	-	0	0
	Total	20-Apr-97		110,538		6-May-97	9-May-97	5	797	0.1384	0.04		
6-1-11-5-15	Lower Merced (MRFF)	54	61	24,398	75	4-May-97	14-May-97	6	2197	0.1387	0.23	24	18
6-1-11-6-1	Lower Merced (MRFF)	54	61	29,011	75	4-May-97	9-May-97	3	1197	0.1385	0.10	72	12
6-1-11-6-2	Lower Merced (MRFF)	54	61	25,761	75	3-May-97	12-May-97	7	1997	0.1387	0.25	24	2
6-1-11-6-3	Lower Merced (MRFF)	54	61	25,317	75	-	-	0	-	-	-	24	4
	Total	22-Apr-97		104,487		3-May-97	14-May-97	16	2397	0.1387	0.14		
6-1-11-6-7	Upper Tuolumne (MRFF)	55	48	31,112	71	18-May-97	18-May-97	1	170	0.1181	0.04	72	12
6-1-11-6-8	Upper Tuolumne (MRFF)	55	48	29,947	71	-	-	0	-	-	-	180	16
6-1-11-6-9	Upper Tuolumne (MRFF)	55	48	24,551	71	24-May-97	24-May-97	1	200	0.1389	0.04	96	8
6-1-11-6-10	Upper Tuolumne (MRFF)	55	48	7,897	71	18-May-97	18-May-97	1	170	0.1181	0.14	12	0
	Total	22-Apr-97		93,507		18-May-97	24-May-97	3	1170	0.1161	0.04		
6-1-11-6-4	Lower Tuolumne (MRFF)	56	56	25,241	75	11-May-97	18-May-97	6	1570	0.1363	0.23	48	28
6-1-11-6-5	Lower Tuolumne (MRFF)	56	56	25,692	75	11-May-97	18-May-97	2	1570	0.1363	0.07	60	14
6-1-11-6-6	Lower Tuolumne (MRFF)	56	56	21,531	75	8-May-97	21-May-97	4	2570	0.1275	0.19	84	6
	Total	23-Apr-97		72,464		8-May-97	21-May-97	12	2570	0.1275	0.17		
6-1-11-6-11	Upper Merced (MRFF)	12-May-97	N/A	55	28,031	76	-	-	0	-	-	12	0

6-1-11-6-14	Lower Merced (MRFF)	61	66	33,064	67	-	-	0	-	-		180	8
6-1-11-6-15	Lower Merced (MRFF)	61	66	28,294	67	28-May-97	28-May-97	1	200	0.1389	0.03	132	18
6-1-11-7-1	Lower Merced (MRFF)	61	66	24,943	67	-	-	0	-	-		96	0
6-1-11-7-2	Lower Merced (MRFF)	61	66	5,856	67	-	-	0	-	-		24	0
	Total	14-May-97		92,157		28-May-97	28-May-97	1	200	0.1389	0.01		

1996

Late-fall run releases

Upper Sacramento River and Tributaries

5-36-27	Battle Creek (CNFH)	N/A	N/A	61,790	122	20-Dec-95	20-Dec-95	2	155	0.1076	0.04	0	24	210	
5-41-16	Battle Creek (CNFH)	N/A	N/A	64,794	116	28-Dec-95	24-Jan-96	3	3101	0.0769	0.08	0	9	201	
	Total	9-Nov-95		126,584		20-Dec-95	24-Jan-96	5	3256	0.0628	0.08				
5-41-7	Battle Creek (CNFH)	N/A	N/A	77,196	123	20-Dec-95	29-Jan-96	17	4256	0.0721	0.40	24	38	393	
5-41-9	Battle Creek (CNFH)	N/A	N/A	63,618	126	28-Dec-95	1-Feb-96	6	4701	0.0907	0.14	36	24	564	
	Total	8-Dec-95		140,814		20-Dec-95	1-Feb-96	23	4835	0.0763	0.28				
5-34-16	Battle Creek (CNFH)	N/A	N/A	61,858	121	11-Jan-96	15-Mar-96	31	9027	0.0964	0.68	72	194	257	
5-36-18	Battle Creek (CNFH)	N/A	N/A	133,985	134	12-Jan-96	26-Mar-96	56	9927	0.0919	0.59	108	625	1120	
	Total	2-Jan-96		195,843		11-Jan-96	26-Mar-96	87	10027	0.0916	0.63				
5-41-17	Battle Creek (CNFH)	N/A	N/A	67,737	143	17-Jan-96	21-Mar-96	35	8526	0.0911	0.74	84	271	667	
5-41-18	Battle Creek (CNFH)	N/A	N/A	64,801	110	17-Jan-96	7-Mar-96	16	6926	0.0943	0.34	12	26	301	
5-41-8	Battle Creek (CNFH)	N/A	N/A	68,931	132	14-Jan-96	4-Mar-96	28	7126	0.0970	0.54	60	308	470	
	Total	3-Jan-96		201,469		14-Jan-96	21-Mar-96	79	9126	0.0932	0.55				
5-41-19	Battle Creek (CNFH)	10-Jan-96	N/A	N/A	67,076	114	21-Jan-96	25-Mar-96	13	7906	0.0845	0.30	36	34	341
5-36-28	Battle Creek (CNFH)	11-Jan-96	N/A	N/A	65,457	127	19-Jan-96	21-Mar-96	24	8106	0.0894	0.53	72	126	384

**Sacramento-San
Joaquin Estuary**

5-41-12	Courtland (CNFH)	9-Jan-96	53	52	34,961	131	15-Jan-96	13-Feb-96	26	5340	0.1236	0.78	72	469	227
5-41-13	Georgiana Sl. (CNFH)	10-Jan-96	55	52	33,670	125	19-Jan-96	16-Feb-96	5	4720	0.1130	0.17	180	588	147
5-41-14	Ryde (CNFH)	11-Jan-96	52	51	30,494	122	17-Jan-96	27-Jan-96	21	2160	0.1364	0.66	12	0	242
5-41-11	Port Chicago (CNFH)	11-Jan-96	NA	NA	34,596	145	17-Jan-96	28-Jan-96	20	-	-		0	0	265

Fall run releases

**Upper Sacramento
River and Tributaries**

5-1-2-1-14	Battle Creek (CNFH)	14-Mar-96	N/A	N/A	295,384	65	29-Mar-96	26-May-96	62	9600	0.1130	0.24	0	4	712
5-1-2-1-15	Battle Creek (CNFH)	29-Mar-96	N/A	N/A	308,443	68	8-Apr-96	27-May-96	89	8940	0.1242	0.30	0	0	1366
6-1-14-5-13	Feather River (FRH)		N/A	N/A	51,844	58	17-Apr-96	20-May-96	27	6740	0.1377	0.49	0	0	376
6-1-14-5-14	Feather River (FRH)		N/A	N/A	57,529	58	30-Apr-96	20-May-96	29	4140	0.1369	0.48	0	0	385
6-1-14-5-15	Feather River (FRH)		N/A	N/A	50,724	58	28-Apr-96	17-May-96	22	3940	0.1368	0.41	0	0	322
6-1-14-6-5	Feather River (FRH)		N/A	N/A	53,612	58	15-Apr-96	17-May-96	32	6540	0.1376	0.56	0	0	405
	Total	5-Apr-96			213,709		15-Apr-96	20-May-96	110	7340	0.1416	0.47			
5-1-2-2-1	Battle Creek (CNFH)	23-Apr-96	N/A	N/A	268,960	80	1-May-96	28-May-96	125	5540	0.1374	0.44	0	0	1928
6-1-6-1-3	Feather River (FRH)	3-May-96	N/A	N/A	100,033	80	8-May-96	30-May-96	57	4540	0.1371	0.54	0	0	1016
6-1-14-6-1	Yuba City (FRH)		N/A	N/A	50,890	87	19-May-96	31-May-96	58	2600	0.1389	1.07	0	0	741
6-1-14-6-2	Yuba City (FRH)		N/A	N/A	51,610	87	19-May-96	31-May-96	70	2600	0.1389	1.27	0	0	874
6-1-14-6-3	Yuba City (FRH)		N/A	N/A	51,300	87	19-May-96	30-May-96	67	2400	0.1389	1.22	0	0	776
6-1-14-6-4	Yuba City (FRH)		N/A	N/A	50,371	87	19-May-96	3-Jun-96	53	2760	0.1198	1.14	0	0	763
	Total	15-May-96			204,171		19-May-96	3-Jun-96	248	2760	0.1198	1.32			

Sacramento-San

Joaquin Estuary

6-1-13-1-7	Woodbridge Dam (MOK)	10-Apr-96	N/A	N/A	3,852	93	23-May-96	23-May-96	1	200	0.1389	0.24	0	0	17
6-1-14-5-5	Turner Cut (FRH)	17-Apr-96	52	63	50,103	79	30-Apr-96	15-May-96	5	3140	0.1363	0.10	12	0	19
6-1-6-1-8	Miller Park (FRH)	25-Apr-96	48	57	49,708	81	30-Apr-96	16-May-96	58	3340	0.1364	1.11	0	0	632
6-1-6-2-2	Miller Park (FRH)	6-May-96	58	65	49,881	83	10-May-96	23-May-96	30	2740	0.1359	0.58	12	0	542
6-1-6-1-11	Turner Cut (FRH)		56	70	48,100	82	9-May-96	13-May-96	3	940	0.1306	0.06	12	0	29
6-1-6-1-12	Turner Cut (FRH)		62	70	49,923	84	11-May-96	11-May-96	1	180	0.1250	0.02	12	0	43
	Total	2-May-96			98,023		9-May-96	13-May-96	4	940	0.1306	0.04			
6-1-14-5-6	Benicia (FRH)	7-May-96	51	66	51,288	84	11-May-96	16-May-96	2	-	-		0	0	774
6-2-16	Mokelumne (MOK)		N/A	N/A	49,946	90	20-May-96	3-Jun-96	14	2560	0.1185	0.31	0	24	252
6-2-17	Mokelumne (MOK)		N/A	N/A	52,123	91	20-May-96	25-May-96	11	1200	0.1389	0.20	0	0	233
	Total	15-May-96			102,069		20-May-96	3-Jun-96	25	2560	0.1185	0.27			
6-2-20	Mokelumne (MOK)		N/A	N/A	52,382	107	8-Jun-96	8-Jun-96	1	200	0.1389	0.02	12	0	14
6-2-21	Mokelumne (MOK)		N/A	N/A	52,205	102	8-Jun-96	8-Jun-96	1	200	0.1389	0.02	0	4	4
	Total	4-Jun-96			104,587		8-Jun-96	8-Jun-96	2	200	0.1389	0.02			
6-1-6-1-14	Mossdale (FRH)		49.5	59.5	49,024	78	-	-	0	-	-		480	32	31
6-1-6-1-15	Mossdale (FRH)		49.5	59.5	51,718	78	25-Apr-96	27-Apr-96	2	600	0.1389	0.04	576	2	68
	Total	15-Apr-96			100,742		25-Apr-96	27-Apr-96	2	600	0.1389	0.02			
6-1-6-1-13	Jersey Point (FRH)	18-Apr-96	50	62	50,041	78	21-Apr-96	3-Jun-96	25	8300	0.1310	0.50	0	0	330
6-1-6-2-1	Mossdale (FRH)		61.5	64	50,462	81	7-May-96	7-May-96	1	200	0.1389	0.02	552	70	15
6-1-6-2-5	Mossdale (FRH)		61.5	64	49,194	81	-	-	0	-	-		780	35	15
	Total	30-Apr-96			99,656		7-May-96	7-May-96	1	200	0.1389	0.01			

6-1-6-2-3	Dos Reis (FRH)		52	63	49,868	83	9-May-96	23-May-96	2	2940	0.1361	0.04	0	0	42
6-1-6-1-10	Dos Reis (FRH)		52	63	48,770	84	11-May-96	11-May-96	1	180	0.1250	0.02	0	0	27
	Total	1-May-96			98,819		9-May-96	23-May-96	3	2940	0.1361		0.03		
6-1-11-4-12	Dos Reis (MRFF)		57	63	25,530	84	8-May-96	10-May-96	2	600	0.1389	0.07	0	0	3
6-1-11-4-14	Dos Reis (MRFF)		57	63	18,459	84	6-May-96	6-May-96	1	200	0.1389	0.05	0	0	8
6-1-11-4-13	Dos Reis (MRFF)		57	63	28,079	84	5-May-96	7-May-96	2	600	0.1389	0.07	0	0	37
6-1-11-4-15	Dos Reis (MRFF)		57	63	35,893	84	8-May-96	12-May-96	5	980	0.1361	0.13	0	0	10
	Total	1-May-96			107,961		5-May-96	12-May-96	10	1580	0.1372		0.09		
6-1-6-1-9	Jersey Point (FRH)	3-May-96	51	64	50,820	87	6-May-96	19-May-96	24	2740	0.1359	0.45	12	0	309
6-1-11-5-1	Jersey Point (MRFF)	3-May-96	50	66	51,737	77	5-May-96	22-May-96	39	3540	0.1366	0.72	0	0	180
6-1-6-2-6	Dos Reis (FRH)	9-May-96	54	60	50,168	83	-	-	0	-	-	-	0	8	25
6-1-6-2-4	Dos Reis (FRH)	16-May-96	51	62	50,243	88	-	-	0	-	-	-	12	36	92
6-2-18	Jersey Point (MOK)		N/A	N/A	50,832	97	22-May-96	29-May-96	88	1600	0.1389	1.62	0	0	1044
6-2-19	Jersey Point (MOK)		N/A	N/A	52,389	90	21-May-96	30-May-96	107	2000	0.1389	1.91	0	0	992
	Total	20-May-96			103,221		21-May-96	30-May-96	195	2000	0.1389		1.77		
6-57-61	Mokelumne (MOK)	26-Sep-95			75,248	146	16-Feb-96	16-Feb-96	1	200	0.1389	0.01	0.01		299
Upper San Joaquin River and Tributaries															
6-1-11-4-8	Upper Merced (MRFF)		N/A	N/A	21,011	80	-	-	0	-	-	-	36	1	12
6-1-11-4-9	Upper Merced (MRFF)		N/A	N/A	21,069	80	-	-	0	-	-	-	12	7	5
6-1-11-4-10	Upper Merced (MRFF)		N/A	N/A	22,638	80	8-May-96	8-May-96	1	200	0.1389	0.04	144	0	5
6-1-11-4-11	Upper Merced (MRFF)		N/A	N/A	21,693	80	-	-	0	-	-	-	96	1	0
	Total	25-Apr-96			86,411		8-May-96	8-May-96	1	200	0.1389		0.01		

6-1-11-5-3	Lower Merced (MRFF)		N/A	N/A	21,705	93	-	-	0	-	-		36	3	1
6-1-11-5-4	Lower Merced (MRFF)		N/A	N/A	22,019	93	5-May-96	5-May-96	1	200	0.1389	0.04	72	1	8
6-1-11-5-5	Lower Merced (MRFF)		N/A	N/A	20,613	93	-	-	0	-	-		144	8	3
	Total	26-Apr-96			64,337		5-May-96	5-May-96	1	200	0.1389	0.01			
6-1-11-5-6	Upper Tuolumne (MRFF)		N/A	N/A	21,601	88	-	-	0	-	-		168	19	7
6-1-11-5-7	Upper Tuolumne (MRFF)		N/A	N/A	22,864	88	2-May-96	6-May-96	2	1000	0.1389	0.08	84	9	9
6-1-11-5-8	Upper Tuolumne (MRFF)	26-Apr-96	N/A	N/A	22,984	88	6-May-96	6-May-96	1	200	0.1389	0.04	132	26	8
	Total				67,449		2-May-96	6-May-96	3	1000	0.1389	0.04			
6-1-11-5-9	Upper Tuolumne (MRFF)		N/A	N/A	22,756	90	2-May-96	2-May-96	1	200	0.1389	0.04	156	13	3
6-1-11-5-10	Upper Tuolumne (MRFF)		N/A	N/A	27,779	90	1-May-96	8-May-96	3	1600	0.1389	0.10	204	2	13
	Total	27-Apr-96			50,535	90	1-May-96	8-May-96	4	1600	0.1389	0.07			

1995

Late-fall run releases

Upper Sacramento River and Tributaries

5-36-22	Battle Creek (CNFH)	10-Nov-94	N/A	N/A	61,673	120	6-Dec-94	21-Jan-95	19	8435	0.1246	0.32	36	53	263
5-37-42	Battle Creek (CNFH)	7-Dec-94	N/A	N/A	62,356	127	22-Dec-94	25-Jan-95	27	6034	0.1197	0.47	60	161	276
5-35-46	Battle Creek (CNFH)		N/A	N/A	56,340	121	11-Jan-95	3-Mar-95	14	6797	0.0908	0.36	12	50	244
5-36-20	Battle Creek (CNFH)		N/A	N/A	125,754	138	11-Jan-95	17-Mar-95	64	7829	0.0824	0.80	36	422	1698
5-36-21	Battle Creek (CNFH)		N/A	N/A	128,159	127	11-Jan-95	7-Apr-95	34	9228	0.0737	0.47	96	136	1259
	Total	5-Jan-95			310,253		11-Jan-95	7-Apr-95	112	9228	0.0737	0.64			
5-37-43	Battle Creek (CNFH)	11-Jan-95	N/A	N/A	62,847	114	18-Jan-95	8-Mar-95	20	5797	0.0805	0.51	12	44	330

**Sacramento-San
Joaquin Estuary**

5-34-25	Georgiana Sl. (CNFH)	5-Dec-94	N/A	N/A	31,532	112	19-Dec-94	6-Jan-95	4	2880	0.1053	0.16	48	39	12
5-34-26	Isleton (CNFH)	5-Dec-94	N/A	N/A	30,220	115	11-Dec-94	3-Jan-95	15	3879	0.1122	0.57	0	6	27
6-25-25	Georgiana Sl. (CNFH)	4-Jan-95	N/A	N/A	31,328	128	12-Jan-95	16-Jan-95	2	1000	0.1389	0.06	120	717	101
6-25-24	Isleton (CNFH)	5-Jan-95	N/A	N/A	31,557	132	9-Jan-95	14-Jan-95	13	1200	0.1389	0.39	48	183	246

Fall run releases

**Upper Sacramento
River and Tributaries**

5-1-1-12-4	Below RBDD (CNFH)		N/A	N/A	50,410	49	25-Apr-95	30-May-95	13	7016	0.1353	0.25	0	0	394
5-1-1-12-5	Below RBDD (CNFH)		N/A	N/A	45,472	49	24-Apr-95	21-May-95	30	5399	0.1339	0.64	0	0	327
	Total	10-Mar-95			95,882		24-Apr-95	30-May-95	43	7195	0.1350	0.43			
6-1-6-1-4	Feather River Hatchery		48	50	54,304	49	25-Apr-95	29-May-95	14	6816	0.1352	0.25	0	0	366
6-1-6-1-5	Feather River Hatchery		48	50	52,394	49	10-Apr-95	22-May-95	19	7359	0.1188	0.40	0	0	331
6-1-6-1-6	Feather River Hatchery		48	50	51,631	49	26-Apr-95	21-May-95	18	5020	0.1341	0.34	0	0	480
6-1-6-1-7	Feather River Hatchery		48	50	38,635	49	24-Apr-95	26-May-95	14	6395	0.1346	0.35	0	0	249
	Total	3-Apr-95			196,964		10-Apr-95	29-May-95	65	8755	0.1216	0.35			
5-1-1-12-6	Battle Creek (CNFH)		N/A	N/A	52,442	79	2-May-95	16-May-95	20	2820	0.1306	0.38	0	0	513
5-1-1-12-7	Battle Creek (CNFH)		N/A	N/A	49,636	75	1-May-95	30-May-95	26	5816	0.1346	0.51	0	0	492
5-1-1-12-8	Battle Creek (CNFH)		N/A	N/A	50,109	64	5-May-95	23-Jun-95	12	9416	0.1308	0.24	0	0	337
	Total	24-Apr-95			152,187		1-May-95	23-Jun-95	58	10216	0.1314	0.38			
6-25-26	Yuba City Ramp (FRH)		N/A	N/A	52,249	77	22-May-95	4-Jun-95	22	2796	0.1387	0.39	0	0	578
6-25-27	Yuba City Ramp (FRH)		N/A	N/A	53,398	77	23-May-95	7-Jun-95	22	3196	0.1387	0.39	0	0	705
6-25-28	Yuba City Ramp (FRH)		N/A	N/A	53,486	77	22-May-95	8-Jun-95	24	3596	0.1387	0.42	0	0	829
6-25-29	Yuba City Ramp (FRH)		N/A	N/A	42,525	77	23-May-95	8-Jun-95	16	3396	0.1387	0.35	0	0	697

Total	18-May-95			201,658		22-May-95	8-Jun-95	84	3596	0.1387	0.39		
-------	-----------	--	--	---------	--	-----------	----------	----	------	--------	------	--	--

Sacramento-San Joaquin Estuary

6-63-47	L. Mokelumne (MOK)	17-Oct-94	N/A	N/A	49,982	160	28-Oct-94	28-Dec-94	2	7079	0.0793	0.07	36	30	117
6-63-48	L. Mokelumne (MOK)	18-Oct-94	N/A	N/A	48,142	160	26-Oct-94	14-Nov-94	4	1600	0.0556	0.19	12	36	195
6-1-14-5-1	Mossdale (FRH)		51	57	50,849	70	25-Apr-95	24-May-95	10	5820	0.1347	0.19	1212	12	187
6-1-14-4-14	Mossdale (FRH)		51	57	50,120	70	26-Apr-95	17-May-95	10	4220	0.1332	0.19	1434	24	224
	Total	17-Apr-95			100,969		25-Apr-95	24-May-95	20	5999	0.1389		0.19		
6-1-14-4-12	Dos Reis (FRH)	17-Apr-95	51	57	50,848	70	5-May-95	26-May-95	8	4216	0.1331	0.15	0	0	198
6-2-11	New Hope Landing (MOK)		N/A	N/A	48,345	80	25-Apr-95	18-May-95	27	4620	0.1337	0.54	0	0	362
6-2-12	New Hope Landing (MOK)		N/A	N/A	49,531	80	25-Apr-95	21-May-95	23	5220	0.1343	0.45	0	0	353
	Total	18-Apr-95			97,876		25-Apr-95	21-May-95	50	5220	0.1343		0.49		
6-1-14-4-13	Jersey Point (FRH)	19-Apr-95	51	60	50,779	70	24-Apr-95	11-May-95	26	3579	0.1381	0.48	0	0	254
6-2-13	New Hope Landing (MOK)		N/A	N/A	49,837	83	2-May-95	17-May-95	26	3020	0.1311	0.52	0	0	325
6-2-14	New Hope Landing (MOK)		N/A	N/A	49,625	83	1-May-95	20-May-95	24	3820	0.1326	0.47	0	0	306
	Total	25-Apr-95			99,462		1-May-95	20-May-95	50	3820	0.1326		0.49		
6-1-14-5-2	Ryde (FRH)	1-May-95	57	59	51,597	81	3-May-95	22-May-95	47	3820	0.1326	0.89	0	0	644
6-1-14-5-3	Miller Park (FRH)	1-May-95	59.5	58.5	50,292	81	4-May-95	21-May-95	32	3420	0.1319	0.63	12	0	743
6-31-50	Mossdale (FRH)		49	62	52,297	76	12-May-95	24-May-95	10	2420	0.1293	0.19	981	20	178
6-31-51	Mossdale (FRH)		49	62	50,265	75	12-May-95	2-Jun-95	3	4216	0.1331	0.06	816	54	166
	Total	5-May-95			102,562		12-May-95	2-Jun-95	13	4216	0.1331		0.12		

6-31-47	Dos Reis (FRH)	5-May-95	50	63	52,097	76	11-May-95	7-Jun-95	21	5416	0.1343	0.39	0	0	362
6-1-14-5-4	Mossdale (FRH)		50	63	52,703	79	29-May-95	29-May-95	1	200	0.1389	0.02	720	66	157
6-31-48	Mossdale (FRH)		50	63	51,422	76	21-May-95	29-May-95	7	1796	0.1386	0.13	780	62	161
	Total	17-May-95			104,125		21-May-95	29-May-95	8	1796	0.1386	0.07			
6-31-49	Dos Reis (FRH)	17-May-95	56	65	51,665	77	23-May-95	2-Jun-95	9	2196	0.1386	0.16	12	0	211
6-2-10	Thornton (MOK)	15-Jun-95	N/A	N/A	51,757	100	19-Jun-95	25-Jun-95	18	1400	0.1389	0.33	0	0	213
6-29-32	Rodeo (FRH)		N/A	N/A	147,816	N/A	-	-	0	-	-	-	0	0	627
6-29-33	Rodeo (FRH)		N/A	N/A	139,443	N/A	-	-	0	-	-	-	0	0	1687
	Total	16-Jun-95			287,259										

Upper San Joaquin River and Tributaries

6-46-23	Merced hatchery		N/A	N/A	7,586	169	12-Dec-94	12-Dec-94	1	200	0.1389	0.12	384	110	22
6-46-24	Merced hatchery		N/A	N/A	10,021	164	-	-	0	-	-	-	84	86	23
6-46-25	Merced hatchery		N/A	N/A	8,904	164	19-Dec-94	19-Dec-94	1	200	0.1389	0.11	240	62	21
	Total	17-Nov-94			26,511		12-Dec-94	19-Dec-94	2	1599	0.1388	0.07			
6-1-2-1-11	Merced hatchery	18-Nov-94	N/A	N/A	48,889	169	10-Dec-94	11-Jan-95	5	5639	0.1187	0.11	2058	565	135
6-1-2-1-12	Merced hatchery		N/A	N/A	48,943	164	18-Dec-94	24-Jan-95	4	6634	0.1212	0.09	996	498	114
6-46-22	Merced hatchery		N/A	N/A	7,600	169	19-Dec-94	19-Dec-94	1	200	0.1389	0.12	264	91	6
	Total	28-Nov-94			56,543		18-Dec-94	24-Jan-95	5	6634	0.1212	0.09			
6-1-11-4-1	Upper Merced (MRFF)		51	51	28,349	84	8-May-95	29-May-95	5	4216	0.1331	0.17	348	108	228
6-1-11-4-2	Upper Merced (MRFF)		51	51	27,961	84	21-May-95	13-Jun-95	3	4796	0.1388	0.10	300	146	192
6-1-11-4-3	Upper Merced (MRFF)		51	51	26,839	84	28-May-95	12-Jun-95	4	3200	0.1389	0.14	596	193	125
6-1-11-4-4	Upper Merced (MRFF)		51	51	28,138	84	23-May-95	6-Jun-95	6	2996	0.1387	0.20	432	137	115
	Total	3-May-95			111,287		8-May-95	13-Jun-95	18	7216	0.1354	0.16			

6-1-11-4-5	Lower Merced (MRFF)	51	59	27,318	82	21-May-95	3-Jun-95	7	2796	0.1387	0.24	384	136	218
6-1-11-4-6	Lower Merced (MRFF)	51	59	27,643	82	21-May-95	9-Jun-95	4	3996	0.1388	0.14	504	125	177
6-1-11-4-7	Lower Merced (MRFF)	51	59	28,054	82	20-May-95	29-May-95	7	1996	0.1386	0.23	432	150	171
	Total	4-May-95		83,015		20-May-95	9-Jun-95	18	4196	0.1388	0.20			
6-1-11-3-11	Upper Tuolumne (MRFF)	51	48	28,068	86	31-May-95	13-Jun-95	8	2800	0.1389	0.27	696	472	276
6-1-11-3-12	Upper Tuolumne (MRFF)	51	48	27,132	86	21-May-95	25-Jun-95	6	6796	0.1311	0.22	660	211	327
6-1-11-3-13	Upper Tuolumne (MRFF)	51	48	28,347	86	29-May-95	14-Jun-95	8	3400	0.1389	0.26	804	274	354
	Total	4-May-95		83,547		21-May-95	25-Jun-95	22	6796	0.1311	0.26			
6-1-11-3-14	Lower Tuolumne (MRFF)	48	51	26,007	89	18-May-95	8-Jun-95	5	4396	0.1388	0.18	756	268	305
6-1-11-3-15	Lower Tuolumne (MRFF)	48	51	27,290	89	20-May-95	26-Jun-95	7	7196	0.1315	0.25	861	207	295
	Total	5-May-95		53,299		18-May-95	26-Jun-95	12	7596	0.1319	0.22			

1994

Late-fall run releases

Upper Sacramento River and Tributaries

5-33-16	Battle Creek (CNFH)	N/A	N/A	52,984	129	18-Jan-94	18-Mar-94	15	5358	0.0620	0.59	48	23	273
5-33-17	Battle Creek (CNFH)	N/A	N/A	55,231	122	-	-	0	-	-		12	4	116
5-34-8	Battle Creek (CNFH)	N/A	N/A	67,645	134	31-Jan-94	9-Mar-94	11	3358	0.0614	0.34	36	6	237
5-34-9	Battle Creek (CNFH)	N/A	N/A	72,236	130	31-Jan-94	25-Feb-94	8	2362	0.0631	0.23	48	4	217
	Total	3-Jan-94		248,096		18-Jan-94	18-Mar-94	34	5358	0.0620	0.29			
5-34-11	Battle Creek (CNFH)	N/A	N/A	78,506	124	31-Jan-94	9-Mar-94	7	3358	0.0614	0.19	24	2	150
5-34-12	Battle Creek (CNFH)	N/A	N/A	69,894	129	2-Feb-94	18-Mar-94	6	3958	0.0611	0.18	24	15	221
5-34-13	Battle Creek (CNFH)	N/A	N/A	78,561	136	28-Jan-94	7-Mar-94	22	3362	0.0599	0.61	72	18	466
5-34-14	Battle Creek (CNFH)	N/A	N/A	65,609	128	2-Feb-94	23-Feb-94	3	1962	0.0619	0.10	24	8	227
	Total	4-Jan-94		292,570		28-Jan-94	18-Mar-94	38	4358	0.0605	0.28			

5-34-15	Battle Creek (CNFH)		N/A	N/A	54,248	123	28-Jan-94	15-Mar-94	13	3958	0.0585	0.53	144	0	220
5-34-10	Battle Creek (CNFH)		N/A	N/A	73,882	127	7-Feb-94	15-Mar-94	7	3171	0.0595	0.21	0	4	145
	Total	5-Jan-94			128,130		28-Jan-94	15-Mar-94	20	3958	0.0585	0.35			

Sacramento-San Joaquin Estuary

6-45-21	Georgiana Sl. (CNFH)	2-Dec-93	N/A	N/A	33,668	119	12-Dec-93	4-Mar-94	5	8337	0.0698	0.28	169	79	79
6-45-22	Ryde (CNFH)	2-Dec-93	N/A	N/A	34,929	129	6-Dec-93	16-Mar-94	37	10553	0.0726	1.90	0	10	287
5-34-17	Clifton Court F. (CNFH)	2-Dec-93	N/A	N/A	12,960	124	1-Dec-93	9-Dec-93	4	1597	0.1232	0.33	0	3	16

Fall run releases

Upper Sacramento River and Tributaries

6-1-6-1-1	Feather River (FRH)	16-Mar-94	49	N/A	103,558	61	15-Apr-94	6-May-94	6	4314	0.1362	0.06	0	0	189
5-1-1-9-8	Below RBDD (CNFH)		N/A	N/A	54,191	45	25-Apr-94	29-Apr-94	2	1000	0.1389	0.03	0	0	24
5-1-1-9-9	Below RBDD (CNFH)		N/A	N/A	57,084	45	23-Apr-94	28-Apr-94	3	1200	0.1389	0.05	0	0	52
	Total	10-Mar-94			111,275		23-Apr-94	29-Apr-94	5	1400	0.1389	0.04			
5-34-27	Coleman (CNFH)		N/A	N/A	54,892	64	28-Apr-94	1-May-94	2	800	0.1389	0.03	0	0	139
5-34-28	Coleman (CNFH)		N/A	N/A	53,430	71	28-Apr-94	8-May-94	8	2200	0.1389	0.14	0	0	251
5-34-29	Coleman (CNFH)		N/A	N/A	52,483	76	24-Apr-94	8-May-94	12	3000	0.1389	0.21	0	0	416
	Total	14-Apr-94			160,805		24-Apr-94	8-May-94	22	3000	0.1389	0.13			
6-1-6-1-2	Feather River (FRH)	2-May-94	49	N/A	100,377	81	14-May-94	14-May-94	1	200	0.1389	0.01	0	0	97

Sacramento-San Joaquin Estuary

6-57-62	Mokelumne River (MOK)	19-Oct-93	N/A	N/A	52,398	135	10-Nov-93	10-Nov-93	3	200	0.1389	0.05	36	55	271
6-57-63	Mokelumne	20-Oct-93	N/A	N/A	52,398	135	9-Nov-93	10-Nov-93	2	400	0.1389	0.04	122	52	346

River (MOK)															
6-1-14-3-14	Lower Old River (FRH)	11-Apr-94	55	62	50,032	74	-	-	0	-	-	-	84	6	3
6-1-14-3-15	Mossdale (FRH)	11-Apr-94	53	63	51,084	74	-	-	0	-	-	-	636	69	62
6-1-14-4-1	Ryde (FRH)	12-Apr-94	54	63	51,819	76	19-Apr-94	1-May-94	11	2600	0.1389	0.20	0	0	375
6-1-14-4-2	Georgiana Sl. (FRH)	12-Apr-94	55	62	51,485	77	20-Apr-94	25-Apr-94	3	1200	0.1389	0.05	0	0	214
6-1-14-4-3	Jersey Point (FRH)	13-Apr-94	57	64	50,689	72	23-Apr-94	3-May-94	10	2200	0.1389	0.18	12	2	410
6-1-14-4-6	Ryde (FRH)	25-Apr-94	54	62	56,139	76	27-Apr-94	11-May-94	10	3000	0.1389	0.17	0	0	664
6-1-14-4-7	Georgiana Sl. (FRH)	25-Apr-94	53	62	50,235	73	3-May-94	20-May-94	6	3600	0.1389	0.11	0	0	151
6-1-14-4-5	Lower Old River (FRH)	26-Apr-94	51	62	50,259	76	-	-	0	-	-	-	72	4	5
6-1-14-4-4	Mossdale (w/barrier) (FRH)	26-Apr-94	49	60	50,726	77	11-May-94	14-May-94	2	800	0.1389	0.04	0	0	87
6-1-14-4-8	Jersey Point (FRH)	27-Apr-94	51	63	53,810	78	2-May-94	22-May-94	16	4200	0.1389	0.28	0	0	748
6-31-41	Mossdale (w/barrier) (FRH)	2-May-94	53	66	51,632	82	-	-	0	-	-	-	12	24	40
6-31-42	Miller Park (FRH)	3-May-94	52	67	53,232	83	7-May-94	15-May-94	4	1800	0.1389	0.07	0	0	219
6-25-17	Benecia (FRH)	4-May-94			102,991	88	-	-	0	-	-	-	0	0	3341
6-31-43	Mossdale (w/barrier) (FRH)	9-May-94	51	68	53,880	88	22-May-94	22-May-94	1	200	0.1389	0.02	0	12	31
6-48-3	New Hope Landing (MOK)		N/A	68	53,606	87	15-May-94	26-May-94	5	2340	0.1354	0.09	0	12	135
6-48-4	New Hope Landing (MOK)		N/A	68	49,864	92	15-May-94	31-May-94	6	3340	0.1364	0.11	12	18	169

	Total	10-May-94			103,470		15-May-94	31-May-94	11	3160	0.1291		0.11			
6-31-44	Benicia (FRH)	10-May-94	58	67	54,297	87	-	-	0	-	-		0	0	1154	
6-48-1	New Hope Landing (MOK)		N/A	67	51,314	97	27-May-94	31-May-94	9	1000	0.1389	0.16	0	0	386	
6-48-2	New Hope Landing (MOK)		N/A	67	51,418	96	27-May-94	6-Jun-94	10	2200	0.1389	0.18	0	2	355	
	Total	23-May-94			102,732		27-May-94	6-Jun-94	19	2200	0.1389		0.17			
6-31-45	Miller Park (FRH)	24-May-94	49	71	49,976	91	-	-	0	-	-		0	0	10	
6-31-46	Benicia (FRH)	31-May-94	N/A	N/A	51,804	88	-	-	0	-	-		0	0	1453	
Upper San Joaquin River and Tributaries																
6-45-16	Merced hatchery		55	55	32,891	165	14-Dec-93	2-May-94	3	15247	0.0756	0.16	1753	205	223	
6-45-17	Merced hatchery		55	55	35,064	165	1-Apr-94	1-Apr-94	1	200	0.1389	0.03	1549	173	206	
	Total	5-Nov-93			67,955		14-Dec-93	2-May-94	4	15247	0.0756		0.10			
6-1-11-2-10	Merced hatchery		53	51	28,315	88	1-May-94	2-May-94	2	400	0.1389	0.07	24	8	54	
6-1-11-2-11	Merced hatchery		53	51	25,328	88	1-May-94	1-May-94	1	200	0.1389	0.04	48	1	149	
6-1-11-2-12	Merced hatchery		53	51	28,532	88	1-May-94	8-May-94	2	1600	0.1389	0.07	24	28	80	
6-1-11-2-13	Merced hatchery		53	51	17,390	88	15-May-94	15-May-94	1	200	0.1389	0.05	24	46	48	
	Total	22-Apr-94			99,565		1-May-94	15-May-94	6	3000	0.1389		0.06			
6-1-11-2-14	Lower Merced (MRFF)		48	62	35,017	87	-	-	0	-	-		24	15	103	
6-1-11-2-15	Lower Merced (MRFF)		48	62	23,324	87	1-May-94	3-May-94	2	600	0.1389	0.08	48	4	43	
6-1-11-3-1	Lower Merced (MRFF)		48	62	23,750	87	-	-	0	-	-		0	0	86	
	Total	22-Apr-94			82,091		1-May-94	3-May-94	2	600	0.1389		0.02			
6-1-11-3-2	Upper Tuolumne (MRFF)		53	51	58,859	85	5-May-94	14-May-94	2	2000	0.1389	0.03	12	6	86	
6-1-11-3-3	Upper		53	51	4,281	85	12-May-94	12-May-94	1	200	0.1389	0.22	12	22	86	

6-1-11-3-4	Tuolumne (MRFF) Upper Tuolumne (MRFF) Total	53	51	20,274	85	-	-	0	-	-	0	4	82	
	23-Apr-94			83,414		5-May-94	14-May-94	3	2000	0.1389	0.03			
6-1-11-3-5	Lower Tuolumne (MRFF)	48	62	36,429	82	6-May-94	6-May-94	1	200	0.1389	0.03	48	0	109
6-1-11-3-6	Lower Tuolumne (MRFF) Total	48	62	13,626	82	8-May-94	8-May-94	1	200	0.1389	0.07	24	14	48
	24-Apr-94			50,055		6-May-94	8-May-94	2	600	0.1389	0.04			

1993

Late-fall run releases

Upper Sacramento River and Tributaries

5-31-21	Battle Creek (CNFH)	N/A	N/A	62,121	N/A	-	-	0	-	-		12	254	600
5-31-22	Battle Creek (CNFH)	N/A	N/A	155,214	N/A	-	-	0	-	-		24	574	1518
5-28-59	Battle Creek (CNFH)	N/A	N/A	52,245	N/A	-	-	0	-	-		0	93	436
5-28-62	Battle Creek (CNFH)	N/A	N/A	52,666	N/A	-	-	0	-	-		0	72	369
	Total			322,246										
	4-Jan-93													

Fall run releases

Upper Sacramento River and Tributaries

5-1-1-8-1	Below RBDD (CNFH)	N/A	N/A	60,509	53	18-Apr-93	6-May-93	22	3679	0.1345	0.35	0	0	439
5-1-1-8-2	Below RBDD (CNFH)	N/A	N/A	63,238	53	19-Apr-93	14-May-93	21	5079	0.1357	0.32	0	0	433
	Total			123,747		18-Apr-93	14-May-93	43	5279	0.1358	0.33			
	10-Mar-93													
6-1-14-11-1	Battle Creek (CNFH)	N/A	50	31,665	72	22-Apr-93	8-May-93	18	3313	0.1353	0.55	0	4	586
6-1-14-11-2	Battle Creek (CNFH)	N/A	50	28,676	72	21-Apr-93	8-May-93	27	3513	0.1355	0.90	12	6	508
	Total			59,076		21-Apr-93	8-May-93	45	3493	0.1348	0.73			
	13-Apr-93													
5-1-1-8-3	Battle Creek (CNFH)	N/A	54	60,361	62	5-May-93	7-Jun-93	22	6615	0.1351	0.35	0	0	808
5-1-1-8-4	Battle Creek	N/A	54	61,615	75	3-May-93	2-Jun-93	57	6015	0.1347	0.89	0	0	1283

5-1-1-8-5	(CNFH) Battle Creek (CNFH) Total		N/A	54	61,981	79	3-May-93	28-May-93	51	5220	0.1394	0.77	0	0	1363
	26-Apr-93				183,957		3-May-93	7-Jun-93	130	6995	0.1349	0.68			
Sacramento-San Joaquin Estuary															
6-1-14-3-6	Mossdale (FRH)	6-Apr-93	52	64	50,016	59	26-Apr-93	20-May-93	2	4936	0.1371	0.04	1272	52	38
6-1-14-3-8	Lower Old River (FRH)	13-Apr-93	56	62	52,747	64	-	-	0	-	-		564	174	39
6-1-14-3-5	Benicia (split release)(FRH)	7&15-Apr- 93	55	60,61	53,066	58	14-Apr-93	12-May-93	12	5697	0.1364	0.22	0	0	434
6-1-14-3-9	Ryde (FRH)	14-Apr-93	57	58	53,265	61	23-Apr-93	22-May-93	23	5936	0.1374	0.41	0	0	527
6-1-14-3-10	Georgiana Sl. (FRH)	14-Apr-93	55	58	53,857	63	2-May-93	17-May-93	7	3140	0.1363	0.12	24	0	204
6-1-14-3-7	Benicia (FRH)	15-Apr-93	53	61	49,335	63	28-Apr-93	23-May-93	5	-	-		0	0	531
6-1-14-11-4	Clifton Court F. (FRH)	21-Apr-93	57	67	25,899	69	-	-	0	-	-		0	84	0
6-1-14-3-11	Miller Park (FRH)	23-Apr-93	53	61	54,454	68	1-May-93	25-May-93	36	4940	0.1372	0.63	12	0	769
6-1-14-11-3	Rio Vista (FRH)	26-Apr-93	54	61	28,056	69	29-Apr-93	18-Jun-93	19	9868	0.1344	0.66	24	0	326
6-1-14-3-12	Mossdale (FRH)	28-Apr-93	57	64	55,742	71	7-May-93	16-May-93	4	2020	0.1403	0.07	1044	60	94
6-1-14-3-13	Miller Park (FRH)	3-May-93	56	62	51,574	71	7-May-93	1-Jun-93	23	5015	0.1339	0.43	24	0	685
6-31-35	Mossdale (FRH)	4-May-93	52	61	51,937	72	11-May-93	21-May-93	4	2220	0.1402	0.07	900	78	111
6-63-41	New Hope Landing (MOK)		N/A	63	50,403	78	13-May-93	27-May-93	15	3020	0.1398	0.28	12	12	298
6-63-42	New Hope Landing (MOK) Total	6-May-93	N/A	63	50,040	78	14-May-93	4-Jun-93	13	4215	0.1330	0.25	12	0	311
					100,443		13-May-93	4-Jun-93	28	4395	0.1327	0.27			

6-31-37	Ryde (FRH)	10-May-93	59	59	49,699	75	13-May-93	30-May-93	43	3400	0.1312	0.86	0	0	1115
6-31-36	Georgiana Sl. (FRH)	10-May-93	62	65	51,560	75	15-May-93	6-Jun-93	15	4395	0.1327	0.29	36	15	356
6-31-38	Mossdale (FRH)	12-May-93	56	65	52,616	75	19-May-93	22-May-93	4	800	0.1389	0.07	1320	134	88
6-63-40															
6-46-51															
6-63-43	New Hope Landing (MOK)		N/A	64	49,543	87	28-May-93	2-Jun-93	4	995	0.1152	0.09	60	0	388
6-63-44	New Hope Landing (MOK)		N/A	64	49,719	87	27-May-93	2-Jun-93	6	1195	0.1186	0.13	60	0	391
	Total	20-May-93			99,262		27-May-93	2-Jun-93	10	1195	0.1186	0.11			
6-31-39	Miller Park (FRH)	21-May-93	51	65	49,786	80	25-May-93	17-Jun-93	18	4592	0.1329	0.35	0	0	563
6-31-40	Miller Park (FRH)	28-May-93	55	64	50,116	82	31-May-93	17-Jun-93	40	3592	0.1386	0.75	0	16	1177

1992

Fall Run Releases

Upper Sacramento River and Tributaries

5-28-12	Battle Creek (CNFH)		N/A	N/A	54,433	79	29-Apr-92	21-May-92	8	4508	0.1361	0.14	0	0	51
5-28-13	Battle Creek (CNFH)		N/A	N/A	49,507	76	25-Apr-92	20-May-92	9	5128	0.1370	0.17	0	0	40
5-28-14	Battle Creek (CNFH)		N/A	N/A	53,886	69	29-Apr-92	20-May-92	3	4328	0.1366	0.05	0	0	7
	Total	14-Apr-92			157,826		25-Apr-92	21-May-92	20	5318	0.1368	0.12			
5-28-18	Red Bluff (CNFH)	15-Apr-92	N/A	N/A	49,373	75	27-Apr-92	19-May-92	18	4528	0.1367	0.35	0	0	36
5-28-19	Princeton (CNFH)	17-Apr-92	N/A	N/A	53,332	74	24-Apr-92	3-May-92	24	1992	0.1383	0.42	2	0	154

Sacramento-San

Joaquin Estuary

6-1-14-2-11	Ryde (FRH)	6-Apr-92	54	64	53,630	77	11-Apr-92	24-Apr-92	78	2796	0.1387	1.36	34	0	360
6-1-14-2-10	Georgiana Sl. (FRH)	6-Apr-92	55	64	51,846	74	14-Apr-92	25-Apr-92	23	2396	0.1387	0.42	4	10	144
6-1-14-2-12	Mosssdale (FRH)		58	64	54,073	78	13-Apr-92	5-May-92	9	4588	0.1385	0.16	2603	25	45
6-1-14-2-13	Mosssdale (FRH)		58	64	53,030	79	13-Apr-92	1-May-92	11	3788	0.1385	0.19	2777	46	31
	Total	7-Apr-92			107,103		13-Apr-92	5-May-92	20	4588	0.1385	0.18			
6-1-14-2-14	Mosssdale (FRH)		55	63	53,754	81	16-Apr-92	27-Apr-92	10	2396	0.1387	0.17	1734	37	8
6-1-14-2-15	Mosssdale (FRH)		55	63	49,958	82	21-Apr-92	1-May-92	3	2190	0.1383	0.06	1651	64	12
	Total	13-Apr-92			103,712		16-Apr-92	1-May-92	13	3188	0.1384	0.12			
6-1-14-3-1	Ryde (FRH)	14-Apr-92	55	63	42,534	82	17-Apr-92	7-May-92	97 (1)	4188	0.1385	2.14	0	0	464 (1)
6-1-14-3-2	Georgiana Sl. (FRH)	14-Apr-92	55	64	52,374	81	17-Apr-92	6-May-92	41	3988	0.1385	0.73	8	12	240
6-63-38	New Hope Landing (MOK)	21-Apr-92	52	66	100,508	110	29-Apr-92	14-May-92	15	3128	0.1358	0.14	8	4	17
6-1-14-3-3	Mosssdale (w/barrier) (FRH)		60	69	53,294	85	3-May-92	6-May-92	7	800	0.1389	0.12	24	15	28
6-1-14-3-4	Mosssdale (w/barrier) (FRH)		61	69	51,445	83	4-May-92	19-May-92	2	3136	0.1361	0.04	4	13	15
	Total	24-Apr-92			104,739		3-May-92	19-May-92	9	3338	0.1364	0.08			
6-31-29	Ryde (FRH)	27-Apr-92	57	67	53,099	81	29-Apr-92	28-May-92	93	5863	0.1357	1.68	0	0	217
6-31-30	Georgiana Sl. (FRH)	27-Apr-92	57	67	51,914	83	1-May-92	10-May-92	11	1940	0.1347	0.20	4	1	35
5-28-30	Benicia (CNFH)	28-Apr-92	N/A	N/A	54,055	80	10-May-92	10-May-92	1	-	-		0	0	858
6-31-31	Mosssdale (w/barrier) (FRH)		62	71	51,262	85	16-May-92	16-May-92	1	200	0.1389	0.02	12	0	0
6-31-32	Mosssdale (w/barrier) (FRH)		62	71	48,455	83	-	-	0	-	-		16	8	0
	Total	4-May-92			99,717		16-May-92	16-May-92	1	200	0.1389	0.01	0.01		

6-63-39	New Hope Landing (MOK)	6-May-92	N/A	72	102,030	106	12-May-92	19-May-92	6	1598	0.1387	0.06	0	0	29
6-31-33	Mossdale (w/barrier) (FRH)		53	72	52,454	85	-	-	0	-	-		0	6	6
6-31-34	Mossdale (w/barrier) (FRH)		53	72	52,931	87	21-May-92	23-May-92	2	575	0.1331	0.04	0	6	3
	Total	12-May-92			105,385		21-May-92	23-May-92	2	575	0.1331	0.02			

1991

Fall Run Releases

Upper Sacramento River and Tributaries

5-1-1-1-13	Battle Creek (CNFH)	30-Apr-91	N/A	N/A	64,373	78	11-May-91	28-May-91	14	3545	0.1368	0.21	0	0	274
5-1-1-1-12	Red Bluff (CNFH)	1-May-91	N/A	N/A	64,118	77	11-May-91	30-May-91	24	3940	0.1368	0.36	0	0	375
5-18-45	Princeton (CNFH)		N/A	N/A	12,474	80	14-May-91	19-May-91	4	1200	0.1389	0.30	0	0	28
5-18-47	Princeton (CNFH)		N/A	N/A	18,713	80	11-May-91	21-May-91	10	2189	0.1382	0.50	0	0	70
5-18-48	Princeton (CNFH)		N/A	N/A	20,792	80	10-May-91	30-May-91	10	4100	0.1356	0.46	0	0	75
	Total	3-May-91			51,979		10-May-91	30-May-91	24	4100	0.1356	0.44			

Sacramento-San Joaquin Estuary

6-1-14-1-14	Dos Reis (FRH)		53	60	52,097	80	23-Apr-91	11-May-91	8	3760	0.1374	0.15	1282	2302	31
6-1-14-1-15	Dos Reis (FRH)		53	60	50,902	80	23-Apr-91	2-May-91	9	2000	0.1389	0.17	2302	1244	58
	Total	15-Apr-91			102,999		23-Apr-91	11-May-91	17	3760	0.1374	0.16			
6-1-14-2-1	Buckley Cove (FRH)				51,128	80	24-Apr-91	6-May-91	15	2600	0.1389	0.27	272	1860	43
6-1-14-2-2	Buckley Cove (FRH)				48,213	78	25-Apr-91	2-May-91	11	1600	0.1389	0.21	66	775	72
	Total	16-Apr-91	53	59	99,341		24-Apr-91	6-May-91	26	2600	0.1389	0.24			

6-1-14-2-3	Empire Tract (FRH)		54	61	48,255	79	24-Apr-91	9-May-91	25	3200	0.1389	0.48	66	792	83
6-1-14-2-4	Empire Tract (FRH)		54	61	47,347	77	24-Apr-91	12-May-91	29	3749	0.1370	0.58	74	609	72
	Total	17-Apr-91			95,602		24-Apr-91	12-May-91	54	3749	0.1370	0.54			
6-1-14-2-5	L. Mokelumne River (FRH)	18-Apr-91	53	61	47,289	79	23-Apr-91	3-May-91	79	2200	0.1389	1.56	0	276	141
6-1-14-2-6	Jersey Point (FRH)	19-Apr-91	55	63	52,139	82	23-Apr-91	17-May-91	94	4949	0.1375	1.70	57	274	357
6-48-37	New Hope Landing (MOK)		NA	NA	8,257	100	29-Apr-91	6-May-91	4	1600	0.1389	0.45	0	0	23
6-48-38	New Hope Landing (MOK)		NA	NA	8,541	100	29-Apr-91	5-May-91	14	1400	0.1389	1.53	0	0	45
6-48-39	New Hope Landing (MOK)		NA	NA	8,601	100	29-Apr-91	3-May-91	14	1000	0.1389	1.52	0	0	51
6-48-40	New Hope Landing (MOK)		NA	NA	8,641	100	27-Apr-91	3-May-91	12	1400	0.1389	1.30	0	0	32
6-48-41	New Hope Landing (MOK)		NA	NA	8,311	100	29-Apr-91	2-May-91	14	800	0.1389	1.58	6	0	22
6-48-42	New Hope Landing (MOK)		NA	NA	7,705	100	28-Apr-91	2-May-91	17	1000	0.1389	2.07	0	48	80
6-48-43	New Hope Landing (MOK)		NA	NA	8,335	100	28-Apr-91	2-May-91	14	1000	0.1389	1.57	0	12	43
6-48-44	New Hope Landing (MOK)		NA	NA	8,614	100	28-Apr-91	2-May-91	12	1000	0.1389	1.30	0	12	10
6-48-45	New Hope Landing (MOK)		NA	NA	9,126	100	29-Apr-91	5-May-91	24	1400	0.1389	2.46	0	12	9
6-48-46	New Hope Landing (MOK)		NA	NA	8,683	100	28-Apr-91	6-May-91	14	1800	0.1389	1.51	4	28	53
	Total	23-Apr-91			84,814		27-Apr-91	6-May-91	139	2000	0.1389	1.53			
6-1-14-2-7	Miller Park (FRH)		54	62	51,392	80	1-May-91	6-May-91	34	1200	0.1389	0.62	8	0	354
6-1-14-2-8	Miller Park (FRH)		54	62	51,272	83	30-Apr-91	9-May-91	50	2000	0.1389	0.91	0	0	275
	Total	25-Apr-91			102,664		30-Apr-91	9-May-91	84	2000	0.1389	0.77			
6-1-14-2-9	Miller Park (FRH)		59	62	53,430	81	27-Apr-91	16-May-91	21	3949	0.1371	0.37	0	0	236
6-31-24	Miller Park (FRH)		59	62	51,086	79	4-May-91	10-May-91	34	1360	0.1349	0.64	1	0	230

	Total	29-Apr-91			104,516		27-Apr-91	16-May-91	55	3949	0.1371		0.50		
6-48-57	New Hope Landing (MOK)		NA	NA	10,510	110	12-May-91	21-May-91	6	1989	0.1381	0.54	0	0	21
6-48-58	New Hope Landing (MOK)		NA	NA	11,595	110	10-May-91	13-May-91	3	749	0.1300	0.26	0	4	57
6-48-59	New Hope Landing (MOK)		NA	NA	10,596	110	11-May-91	16-May-91	7	1189	0.1376	0.62	0	8	13
6-48-60	New Hope Landing (MOK)		NA	NA	11,554	110	10-May-91	13-May-91	5	749	0.1300	0.43	0	0	4
6-48-61	New Hope Landing (MOK)		NA	NA	11,391	110	10-May-91	18-May-91	4	1749	0.1350	0.34	0	0	33
6-48-62	New Hope Landing (MOK)		NA	NA	11,734	110	10-May-91	18-May-91	8	1749	0.1350	0.66	4	0	43
6-48-63	New Hope Landing (MOK)		NA	NA	10,797	110	12-May-91	18-May-91	4	1389	0.1378	0.35	0	1	25
6-49-1	New Hope Landing (MOK)		NA	NA	10,012	110	11-May-91	18-May-91	8	1589	0.1379	0.75	0	0	7
6-49-2	New Hope Landing (MOK)		NA	NA	8,142	110	12-May-91	15-May-91	3	789	0.1370	0.35	0	0	12
6-49-7	New Hope Landing (MOK)		NA	NA	5,142	110	12-May-91	13-May-91	2	389	0.1351	0.37	0	0	0
	Total	6-May-91			101,473		10-May-91	21-May-91	50	2349	0.1359		0.47		
6-31-25	Buckley Cove (FRH)		58	65	49,393	78	11-May-91	30-May-91	7	3940	0.1368	0.13	12	31	57
6-31-26	Buckley Cove (FRH)		58	65	50,427	85	11-May-91	16-May-91	13	1189	0.1376	0.24	40	33	46
	Total	6-May-91			99,820		11-May-91	30-May-91	20	3940	0.1368		0.19		
6-31-27	L. Mokelumne River (FRH)	9-May-91	59	65	45,706	84	12-May-91	18-May-91	31	1389	0.1378	0.64	22	13	229
5-1-1-1-4	Benicia (CNFH)	13-May-91	N/A	N/A	43,750	88	-	-	0	-	-		0	0	741
6-31-28	Jersey Point (FRH)	13-May-91	56	61	49,184	86	14-May-91	23-May-91	89	2000	0.1389	1.69	22	0	276

1990

Fall Run Releases

Upper Sacramento River and Tributaries (2)

5-20-55	Battle Creek (CNFH)	11-May-90	N/A	N/A	51,069	80	19-May-90	5-Jun-90	7	2780	0.1073	0.17	0	0	38
5-20-56	Red Bluff (CNFH)	12-May-90	N/A	N/A	51,533	82	20-May-90	2-Jun-90	3	1980	0.0982	0.08	0	0	33
5-20-57	Princeton (CNFH)	14-May-90	N/A	N/A	52,077	81	20-May-90	22-May-90	5	600	0.1389	0.09	0	0	12
Sacramento-San Joaquin Estuary															
6-1-14-1-8	Dos Reis (FRH)		55	68	53,254	73	26-Apr-90	13-May-90	2	3300	0.1273	0.04	332	566	12
6-1-14-1-7	Dos Reis (FRH)		55	68	52,488	71	12-May-90	15-May-90	2	800	0.1389	0.04	390	478	11
	Total	16-Apr-90			105,742		26-Apr-90	15-May-90	4	3700	0.1285	0.04			
6-1-14-1-6	Upper Old River (FRH)				52,954	72	-	-	0	-	-	-	396	845	5
6-1-14-1-5	Upper Old River (FRH)				53,313	73	24-Apr-90	1-May-90	2	1340	0.1163	0.04	552	884	9
	Total	17-Apr-90	55	70	106,267		24-Apr-90	1-May-90	2	1340	0.1163	0.02			
6-1-14-1-9	Jersey Point (FRH)	18-Apr-90	55	63	52,962	71	21-Apr-90	14-May-90	32	4480	0.1296	0.61	30	126	223
6-1-14-1-10	Dos Reis (FRH)		60	68	52,559	74	13-May-90	16-May-90	3	800	0.1389	0.05	18	34	8
6-1-14-1-11	Dos Reis (FRH)		60	68	50,974	75	16-May-90	16-May-90	1	200	0.1389	0.02	36	62	26
	Total	2-May-90			103,533		13-May-90	16-May-90	4	800	0.1389	0.04			
6-1-14-1-12	Upper Old River (FRH)		54	72	51,521	76	16-May-90	16-May-90	1	200	0.1389	0.02	224	477	5
6-1-14-1-13	Upper Old River (FRH)		54	72	52,074	78	-	-	0	-	-	-	202	443	6
	Total	3-May-90			103,595		16-May-90	16-May-90	1	200	0.1389	0.01			
6-31-19	Jersey Point (3) (FRH)	4-May-90	59	68	50,143	77	6-May-90	25-May-90	56	3660	0.1271	1.14	14	48	207
6-31-18	Sacramento (3) (FRH)	7-May-90	56	70	48,390	74	11-May-90	1-Jun-90	44	3520	0.1111	1.06	6	0	115

6-31-20	Ryde (3) (FRH)	9-May-90	54	69	51,878	79	12-May-90	29-May-90	89	2720	0.1049	2.13	0	0	174
5-20-58	Benicia (CNFH)	22-May-90	N/A	N/A	52,446	82	-	-	0	-	-	-	0	0	244
6-31-23	Sutter Slough (FRH)	29-May-90	59	63	49,324	83	1-Jun-90	14-Jun-90	39	2760	0.1369	0.75	0	0	222
6-31-21	Steamboat Slough (FRH)	30-May-90	51	63	52,010	86	1-Jun-90	12-Jun-90	58	2380	0.1377	1.05	0	0	319
6-31-22	Ryde (FRH)	31-May-90	51	65	50,837	84	2-Jun-90	11-Jun-90	67	1980	0.1375	1.25	0	0	217

**Upper San Joaquin
River and Tributaries**

6-1-11-1-14	Upper Tuolumne (MRFF)		56	52	24,134	83	12-May-90	12-May-90	1	200	0.1389	0.04	152	253	12
6-1-11-1-15	Upper Tuolumne (MRFF)		56	52	24,259	83	16-May-90	16-May-90	1	200	0.1389	0.04	94	231	5
6-1-11-2-1	Upper Tuolumne (MRFF)		56	52	23,494	83	12-May-90	12-May-90	1	200	0.1389	0.04	134	244	0
6-1-11-2-2	Upper Tuolumne (MRFF)		56	52	21,766	83	8-May-90	8-May-90	1	200	0.1389	0.04	60	150	0
	Total	30-Apr-90			93,653		8-May-90	16-May-90	4	1740	0.1343	0.04			
6-1-11-2-3	Lower Tuolumne (TRFF)		48	66	27,263	72	12-May-90	12-May-90	1	200	0.1389	0.03	122	266	1
6-1-11-2-4	Lower Tuolumne (TRFF)		55	66	26,067	72	-	-	0	-	-	-	92	183	17
6-1-11-2-5	Lower Tuolumne (TRFF)		48	66	24,905	72	-	-	0	-	-	-	102	14	0
	Total	1-May-90			78,235		12-May-90	12-May-90	1	200	0.1389	0.01			

1989

Fall Run Releases

**Upper Sacramento
River and Tributaries**

5-20-37	Battle Creek (CNFH)	8-May-89	N/A	N/A	51,074	69	16-May-89	7-Jun-89	13	4178	0.1261	0.26	6	0	84
---------	------------------------	----------	-----	-----	--------	----	-----------	----------	----	------	--------	------	---	---	----

5-20-38	Red Bluff (CNFH)	9-May-89	N/A	N/A	52,677	70	16-May-89	8-Jun-89	18	4378	0.1267	0.35	0	0	91
5-20-39	Princeton (CNFH)	10-May-89	N/A	N/A	50,842	72	11-May-89	31-May-89	27	3800	0.1257	0.55	12	0	90
Sacramento-San Joaquin Estuary															
6-31-14	Dos Reis (FRH)	20-Apr-89	54	69	52,962	85	27-Apr-89	7-May-89	8	2200	0.1389	0.14	428	2286	34
6-31-13	Upper Old River (FRH)	21-Apr-89	54	67	51,972	81	25-Apr-89	4-May-89	5	2000	0.1389	0.09	658	2916	38
6-1-11-1-11	Jersey Point (FRH)		50	64	27,758	70	29-Apr-89	15-May-89	24	3390	0.1385	0.81	0	90	83
6-1-11-1-12	Jersey Point (FRH)		50	64	29,058	70	29-Apr-89	12-May-89	29	2790	0.1384	0.94	12	42	98
	Total	24-Apr-89			56,816		29-Apr-89	15-May-89	53	3390	0.1385	0.88			
6-1-11-1-7	Dos Reis (MRFF)		62	71	25,089	70	10-May-89	30-May-89	3	3800	0.1257	0.12	12	100	28
6-1-11-1-8	Dos Reis (MRFF)		62	71	25,631	70	8-May-89	24-May-89	7	3390	0.1385	0.26	36	78	32
6-1-11-1-13	Dos Reis (MRFF)		62	71	25,353	70	10-May-89	10-May-89	1	200	0.1389	0.04	36	166	18
	Total	2-May-89			76,073		8-May-89	30-May-89	11	4190	0.1265	0.15			
6-31-11	Courtland (FRH)	2-May-89	55	61	51,211	87	5-May-89	16-May-89	46	2390	0.1383	0.84	0	26	247
6-1-11-1-4	Upper Old River (MRFF)		62	70	25,087	70	8-May-89	8-May-89	1	200	0.1389	0.04	428	74	5
6-1-11-1-5	Upper Old River (MRFF)		62	70	24,472	70	9-May-89	9-May-89	1	190	0.1319	0.04	524	22	0
6-1-11-1-6	Upper Old River (MRFF)		62	70	24,782	70	8-May-89	15-May-89	2	1590	0.1380	0.08	107	284	11
	Total	3-May-89			74,341		8-May-89	15-May-89	4	1590	0.1380	0.05			
6-31-12	Ryde (FRH)	3-May-89	54	62	51,046	86	6-May-89	15-May-89	65	1990	0.1382	1.20	0	18	417
6-1-11-1-9	Jersey Point (FRH)		54	68	27,525	73	8-May-89	25-May-89	33	3590	0.1385	1.13	0	508	144
6-1-11-1-10	Jersey Point (FRH)		54	68	28,708	73	8-May-89	22-May-89	25	2990	0.1384	0.82	12	304	141
	Total	5-May-89			56,233		8-May-89	25-May-89	58	3590	0.1385	0.97			
5-20-40	Benicia	15-May-89	N/A	N/A	39,379	72	-	-	0	-	-	-	0	0	196

	(CNFH)															
6-31-10	Miller Park (FRH)	1-Jun-89	51	67	52,612	88	5-Jun-89	8-Jun-89	14	800	0.1389	0.25	0	0	81	
6-31-8	Courtland (FRH)	2-Jun-89	58	69	50,659	92	5-Jun-89	9-Jun-89	19	1000	0.1389	0.35	0	0	42	
6-31-7	Ryde (FRH)	2-Jun-89	56	67	50,601	88	5-Jun-89	14-Jun-89	26	2000	0.1389	0.48	0	0	82	
6-31-9	Port Chicago (FRH)	5-Jun-89	50	67	45,446 (5)	90	6-Jun-89	17-Jun-89	40	-	-		0	0	180	
6-31-15	Miller Park (FRH)		58	70	44,695	84	17-Jun-89	19-Jun-89	11	600	0.1389	0.23	0	0	33	
6-31-17	Miller Park (FRH)		58	70	49,909	83	17-Jun-89	19-Jun-89	9	600	0.1389	0.17	0	0	35	
	Total	14-Jun-89			94,604		17-Jun-89	19-Jun-89	20	600	0.1389	0.20				
6-1-14-1-3	Courtland (west) (FRH)		60	71	52,907	85	17-Jun-89	21-Jun-89	17	1000	0.1389	0.30	0	0	47	
6-58-5	Courtland (east) (FRH)		57	71	37,813	98	18-Jun-89	22-Jun-89	4	1000	0.1389	0.10	0	0	37	
	Total	15-Jun-89			90,720	98	17-Jun-89	22-Jun-89	21	1200	0.1389	0.22				
6-1-14-1-1	Steamboat Sl. (FRH)	13-Jun-89	55	70	51,237	79	15-Jun-89	22-Jun-89	50	1600	0.1389	0.91	0	0	70	
6-31-16	Sutter Slough (FRH)	13-Jun-89	57	69	49,762	83	15-Jun-89	29-Jun-89	57	2875	0.1331	1.12	0	0	152	
6-1-14-1-2	Ryde (FRH)	16-Jun-89	56	73	51,134	85	19-Jun-89	26-Jun-89	8	1480	0.1285	0.16	0	0	10	
6-1-14-1-4	Port Chicago (FRH)	19-Jun-89	54	71	48,329	86	20-Jun-89	22-Jun-89	30	-	-		0	0	353	
Upper San Joaquin River and Tributaries																
B6-14-9	Upper Stanislaus (MRFF)		50	54	52,445	78	29-Apr-89	11-May-89	3	2590	0.1384	0.05	416	1325	17	
B6-14-10	Upper Stanislaus (MRFF)		50	54	51,506	78	30-Apr-89	16-May-89	4	3390	0.1385	0.07	408	1060	17	
	Total	20-Apr-89			103,951		29-Apr-89	16-May-89	7	3590	0.1385	0.06				
B6-1-1	Lower		50	65	25,525	76	24-Apr-89	2-May-89	11	1800	0.1389	0.40	260	1152	24	

B6-14-11	Stanislaus (MRFF) Lower Stanislaus (MRFF) Total	19-Apr-89	50	65	48,695	76	24-Apr-89	27-Apr-89	6	800	0.1389	0.12	460	1754	35
					74,220		24-Apr-89	2-May-89	17	1800	0.1389	0.21			
6-1-11-1-1	Lower Merced (MRFF)		56	70	25,357	66	3-May-89	10-May-89	3	1590	0.1380	0.11	236	490	3
6-1-11-1-2	Lower Merced (MRFF)		56	70	25,276	66	15-May-89	15-May-89	1	200	0.1389	0.04	387	324	2
6-1-11-1-3	Lower Merced (MRFF)		56	70	23,832	66	-	-	0	-	-		192	269	0
	Total	21-Apr-89			74,465		3-May-89	15-May-89	4	2590	0.1384	0.05			
B6-14-12	Lower Stanislaus (MRFF)	3-May-89	68	66	46,169	72	-	-	0	-	-		680	408	12

1988

Fall Run

Upper Sacramento River and Tributaries

5-19-39	Battle Creek (CNFH)	9-May-88	N/A	N/A	51,923	84	10-May-88	25-May-88	45	6315	0.2741	0.41	0	0	393
5-19-40	Red Bluff (CNFH)	10-May-88	N/A	N/A	52,796	84	10-May-88	25-May-88	37	6315	0.2741	0.33	0	0	468
5-19-41	Princeton (CNFH)	11-May-88	N/A	N/A	52,771	85	15-May-88	25-May-88	43	4315	0.2724	0.39	0	0	413

Sacramento-San Joaquin Estuary

B6-14-2	Courtland (FRH)				51,388		7-May-88	21-May-88	71	5990	0.2773	0.65	42	506	559
B6-14-3	Courtland (FRH)				55,861		7-May-88	25-May-88	83	7515	0.2747	0.70	43	484	631
	Total	3-May-88	50	62	107,249	76	7-May-88	25-May-88	154	7515	0.2747	0.68			
6-31-1	Ryde (FRH)	4-May-88	51	63	52,741	86	6-May-88	17-May-88	105	4820	0.2789	0.93	0	0	1074
B6-14-6	Miller Park				51,005		8-May-88	23-May-88	77	6330	0.2747	0.71	0	210	574

B6-14-7	(FRH) Miller Park (FRH) Total	5-May-88	54	62	51,731 102,736	78	9-May-88 8-May-88	21-May-88 23-May-88	65 142	5190 6330	0.2772 0.2747	0.59	4	266	543
B6-14-4	Courtland (FRH)		49		51,274		8-May-88	27-May-88	67	7310	0.2538	0.67	0	220	414
B6-14-5	Courtland (FRH) Total	6-May-88	51	61	51,206 102,480	78	10-May-88 8-May-88	21-May-88 27-May-88	80 147	4790 7310	0.2772 0.2538	0.73	26	204	521
6-31-2	Ryde (FRH)	6-May-88	52	61	53,238	88	8-May-88	18-May-88	145 (6)	4400	0.2778	1.27	0	0	1324
B6-14-8	Port Chicago (FRH)	11-May-88	54	70	55,265	84	-	-	0	-	-		0	0	1116
5-18-42	Benicia (CNFH)	17-May-88	N/A	N/A	51,651	88	-	-	0	-	-		0	0	328
6-62-59	Courtland (FRH)		51	73	54,997	87	23-Jun-88	29-Jun-88	25	2800	0.2778	0.21	0	0	551
6-62-60	Courtland (FRH) Total	21-Jun-88	51	73	51,904 106,901	87	23-Jun-88 23-Jun-88	3-Jul-88 3-Jul-88	14 39	4400 4400	0.2778 0.2778	0.13	0	0	488
6-62-63	Ryde (FRH)	22-Jun-88	51	75	53,961	84	23-Jun-88	4-Jul-88	46	4800	0.2778	0.40	0	0	250
6-62-61	Miller Park (FRH)		55	74	49,245	89	26-Jun-88	7-Jul-88	7 (7)	3960	0.2292	0.08	0	0	79
6-62-62	Miller Park (FRH) Total	23-Jun-88	55	74	48,647 97,892	89	26-Jun-88 26-Jun-88	3-Jul-88 7-Jul-88	7 (7) 14	3200 3960	0.2778 0.2292	0.07	0	0	63
6-62-50	Courtland (FRH)	24-Jun-88	53	76	99,827	74	28-Jun-88	3-Jul-88	5	2400	0.2778	0.02	0	0	71
6-31-5	Steamboat Slough (FRH)		55	76	49,342	88	26-Jun-88	3-Jul-88	39	3200	0.2778	0.37	0	0	183
6-31-6	Steamboat Slough (FRH) Total	24-Jun-88	55	76	47,975 97,317	88	25-Jun-88 25-Jun-88	1-Jul-88 3-Jul-88	40 79	2800 3600	0.2778 0.2778	0.39	0	0	207
6-31-3	Ryde (FRH)	25-Jun-88	50	74	53,942	88	26-Jun-88	1-Jul-88	39	2400	0.2778	0.34	0	0	286

6-31-4	Port Chicago (FRH)	29-Jun-88	49	76	54,151	91	-	-	0	-	-	0	0	1032
--------	--------------------	-----------	----	----	--------	----	---	---	---	---	---	---	---	------

Upper San Joaquin River and Tributaries

B6-11-5	Upper Stanislaus (MRFF)		50	55	36,769	78	4-May-88	11-May-88	6	3220	0.2795	0.08	874	2166	35
B6-11-6	Upper Stanislaus (MRFF)		50	55	34,906	78	12-May-88	21-May-88	5	3990	0.2771	0.07	838	1952	63
	Total	26-Apr-88			71,675		4-May-88	21-May-88	11	7210	0.2782	0.07			
B6-11-3	Lower Stanislaus (MRFF)		62	66	35,249	79	3-May-88	19-May-88	6	6620	0.2704	0.08	2905	2116	156
B6-11-4	Lower Stanislaus (MRFF)		62	66	33,539	79	7-May-88	22-May-88	7	6330	0.2747	0.10	3072	2303	112
	Total	26-Apr-88			68,788		3-May-88	22-May-88	13	7750	0.2691	0.09			

1987

Fall Run Releases

Upper Sacramento River and Tributaries

H6-7-7	Below RBDD (CNFH)	13-Mar-87	N/A	N/A	52,977	52	27-Apr-87	11-May-87	4	-	-	0	1*	113	
B5-4-13	Battle Creek (CNFH)	12-Mar-87	N/A	N/A	51,075	51	21-Apr-87	30-Apr-87	5	-	-	1*	0	182	
5-18-39	Battle Creek (CNFH)	12-May-87	N/A	N/A	51,706	84	18-May-87	21-May-87	10	790	0.1372	0.18	0	0	458
5-18-40	Red Bluff (CNFH)	13-May-87	N/A	N/A	51,807	84	19-May-87	22-May-87	6	790	0.1372	0.11	0	0	367
5-18-41	Princeton (CNFH)	14-May-87	N/A	N/A	51,271	84	19-May-87	19-May-87	1	190	0.1319	0.02	0	0	176

Sacramento-San Joaquin Estuary

H6-7-6	Courtland (CNFH)	5-Mar-87	N/A	N/A	48,733	50	26-Apr-87	26-Apr-87	1	-	-	4*	3*	28	
6-45-3	Upper Old		60	72	31,099	79	30-Apr-87	6-May-87	8	1435	0.1424	0.23	6177	2149	171

6-45-4	River (MRFF) Upper Old River (MRFF)	60	72	29,253	79	30-Apr-87	5-May-87	5	1235	0.1429	0.16	5158	2153	149	
6-45-5	Upper Old River (MRFF)	60	72	30,600	79	30-Apr-87	3-May-87	3	845	0.1467	0.09	6277	2105	179	
	Total	27-Apr-87		90,952		30-Apr-87	6-May-87	16	1435	0.1424	0.16				
6-45-6	Dos Reis (MRFF)	55	70	30,919	80	5-May-87	13-May-87	30	1765	0.1362	0.93	524	1421	376	
6-45-7	Dos Reis (MRFF)	55	70	31,634	80	5-May-87	20-May-87	22	3135	0.1361	0.66	472	1451	436	
6-45-8	Dos Reis (MRFF)	55	70	30,059	80	5-May-87	12-May-87	28	1565	0.1359	0.89	532	1069	408	
	Total	27-Apr-87		92,612		5-May-87	20-May-87	80	3135	0.1361	0.83				
6-62-53	Courtland (FRH)	57	67	49,781	81	1-May-87	12-May-87	32	2410	0.1395	0.60	27	28	995	
6-62-54	Courtland (FRH)	55	67	50,521	81	1-May-87	14-May-87	39	2810	0.1394	0.72	13	114	987	
	Total	28-Apr-87		100,302		1-May-87	14-May-87	71	2810	0.1394	0.66				
6-62-55	Ryde (FRH)	29-Apr-87	50	67	51,103	79	2-May-87	12-May-87	46	2210	0.1395	0.84	0	0	1612
6-62-56	Courtland (FRH)	57	67	49,083	79	4-May-87	15-May-87	20	2365	0.1369	0.39	0	0	739	
6-62-57	Courtland (FRH)	55	67	51,836	79	5-May-87	22-May-87	23	3535	0.1364	0.42	7	180	695	
	Total	1-May-87		100,919		4-May-87	22-May-87	43	3735	0.1365	0.41				
6-62-58	Ryde (FRH)	2-May-87	53	64	51,008	80	5-May-87	15-May-87	47	2165	0.1367	0.88	0	0	1038
Upper San Joaquin River and Tributaries															
6-46-60	Upper Tuolumne (MRFF)	58	55	29,959	85	25-Apr-87	1-May-87	2	1395	0.1384	0.06	520	98	33	
6-46-61	Upper Tuolumne (MRFF)	58	55	30,601	85	-	-	0	-	-	-	574	132	31	
6-46-62	Upper Tuolumne (MRFF)	58	55	29,040	85	28-Apr-87	30-Apr-87	3	595	0.1377	0.10	550	110	27	
	Total	16-Apr-87		89,600		25-Apr-87	1-May-87	5	1395	0.1384	0.05				
6-45-1	Lower Tuolumne (MRFF)	50	64	31,866	82	22-Apr-87	4-May-87	5	2640	0.1410	0.14	738	1810	141	
6-45-2	Lower	50	64	30,936	82	22-Apr-87	5-May-87	9	2830	0.1404	0.27	934	1702	87	

6-46-63	Tuolumne (MRFF) Lower Tuolumne (MRFF) Total		50	64	30,709	82	26-Apr-87	5-May-87	4	2030	0.1410	0.12	868	1451	143
		16-Apr-87			93,511		22-Apr-87	5-May-87	18	2830	0.1404	0.18			

1986

Fall Run Releases

Upper Sacramento River and Tributaries

H6-7-5	Below RBDD (CNFH)	19-Mar-86	N/A	N/A	51,426	50	25-Apr-86	8-May-86	7	-	-	-	0	0	429
H5-7-7	Battle Creek (CNFH)	18-Mar-86	N/A	N/A	51,371	50	29-Apr-86	17-May-86	8	-	-	-	0	0	221
H5-4-2	Battle Creek (CNFH)		N/A	57	24,933	86	21-May-86	26-May-86	11	1200	0.1389	0.41	0	0	334
H5-4-3	Battle Creek (CNFH)		N/A	57	28,659	86	21-May-86	27-May-86	19	1400	0.1389	0.62	0	0	313
	Total	13-May-86			53,592		21-May-86	27-May-86	30	1400	0.1389	0.52			
H5-4-4	Below RBDD (CNFH)		N/A	58	26,900	87	21-May-86	31-May-86	9	2200	0.1389	0.31	0	0	365
H5-4-5	Below RBDD (CNFH)		N/A	58	27,606	87	20-May-86	1-Jun-86	17	2600	0.1389	0.58	0	0	442
	Total	13-May-86			54,506		20-May-86	1-Jun-86	26	2600	0.1389	0.45			
H5-4-6	Princeton (CNFH)		N/A	62	23,669	86	23-May-86	27-May-86	3	1000	0.1389	0.12	0	0	595
H5-4-7	Princeton (CNFH)		N/A	62	22,719	86	19-May-86	22-May-86	7	800	0.1389	0.29	0	0	421
	Total	14-May-86			56,388		19-May-86	27-May-86	10	1800	0.1389	0.17			

Sacramento-San Joaquin Estuary

H6-6-7	Courtland (CNFH)	27-Feb-86	N/A	N/A	50,961	45	19-Apr-86	19-Apr-86	1	-	-	-	0	0	22
H6-7-3	Courtland (CNFH)	10-Mar-86	N/A	N/A	53,831	50	17-Apr-86	17-Apr-86	2	-	-	-	0	0	85
H6-7-2	Ryde (CNFH)	14-Mar-86	N/A	N/A	52,635	47	-	-	0	-	-	-	0	0	83

H6-7-4	Ryde (CNFH)	12-Mar-86	N/A	N/A	52,748	53	-	-	0	-	-		0	0	127
6-62-43	Courtland (FRH)	27-May-86	N/A	73	98,866	81	31-May-86	10-Jun-86	39	2198	0.1388	0.37	0	8	1692
6-62-46	South Fork Mok. (FRH)	28-May-86	52	68	102,965	77	1-Jun-86	18-Jun-86	24	2978	0.1149	0.26	360	12	984
6-62-47	North Fork Mok. (FRH)	29-May-86	60	72	101,949	74	2-Jun-86	18-Jun-86	33	2778	0.1135	0.37	0	0	1306
6-46-58	Dos Reis (MRH)		N/A	68	47,954	96	2-Jun-86	8-Jun-86	13	1398	0.1387	0.25	260	280	1053
B6-11-1	Dos Reis (MRH)		N/A	68	47,641	96	2-Jun-86	7-Jun-86	22	1198	0.1387	0.43	254	244	1015
	Total	29-May-86			95,595		2-Jun-86	8-Jun-86	35	1398	0.1387			0.34	
6-62-48	Ryde (FRH)	30-May-86	56	74	101,320	81	1-Jun-86	13-Jun-86	74	2598	0.1388	0.68	0	0	1979
6-46-59	Upper Old River (MRFF)		N/A	70	49,434	96	1-Jun-86	6-Jun-86	10	1198	0.1387	0.19	2072	1096	586
B6-11-2	Upper Old River (MRFF)		N/A	70	50,747	96	1-Jun-86	3-Jun-86	11	600	0.1389	0.20	2616	1428	554
	Total	30-May-86			100,181		1-Jun-86	6-Jun-86	21	1198	0.1387			0.20	
6-62-49	Lower Old River (FRH)	31-May-86	60	74	98,869	78	2-Jun-86	8-Jun-86	25	1398	0.1387	0.24	3192	2998	645
6-62-52	Fort Baker (FRH)	3-Jun-86	N/A	N/A	49,583	73	-	-	0	-	-		0	0	1807
6-62-51	Port Chicago (FRH)	2-Jun-86	56	62	47,995	75	6-Jun-86	10-Jun-86	4	-	-		0	0	1382
Upper San Joaquin River and Tributaries															
6-46-54	Upper Tuolumne (MRFF)		N/A	51	49,630	81	25-Apr-86	27-May-86	17	5557	0.1169	0.38	1406	1187	996
6-46-55	Upper Tuolumne (MRFF)		N/A	51	49,518	81	23-Apr-86	21-May-86	18	4557	0.1091	0.43	1906	2125	946
	Total	14-Apr-86			99,148		23-Apr-86	27-May-86	35	5757	0.1142			0.40	

6-46-56	Lower Tuolumne (MRFF)	N/A	51	51,300	80	23-Apr-86	7-May-86	10	1780	0.0824	0.31	1952	1247	992
6-46-57	Lower Tuolumne (MRFF)	N/A	51	52,174	80	25-Apr-86	10-May-86	10	2180	0.0946	0.26	1512	1208	1066
	Total	14-Apr-86		103,474		23-Apr-86	10-May-86	20	2380	0.0918	0.27			
6-46-48	Upper Stanislaus (MRFF)	N/A	52	31,120	86	3-May-86	16-Jun-86	17	8375	0.1292	0.55	1018	370	393
6-46-49	Upper Stanislaus (MRFF)	N/A	52	31,148	86	5-May-86	20-May-86	11	3177	0.1379	0.33	1144	304	433
6-46-50	Upper Stanislaus (MRFF)	N/A	52	24,751	86	7-May-86	7-Jun-86	4	6375	0.1383	0.15	744	434	343
6-46-53	Upper Stanislaus (MRFF)	N/A	52	21,254	86	8-May-86	11-Jun-86	5	6975	0.1384	0.22	612	262	288
	Total	28-Apr-86		108,273		3-May-86	16-Jun-86	37	8375	0.1292	0.34			
6-46-45	Lower Stanislaus (MRFF)	N/A	58	31,491	89	5-May-86	15-May-86	16	2197	0.1387	0.48	1355	1224	661
6-46-46	Lower Stanislaus (MRFF)	N/A	58	31,310	89	5-May-86	25-May-86	18	4177	0.1381	0.54	1378	948	515
6-46-47	Lower Stanislaus (MRFF)	N/A	58	30,530	89	3-May-86	18-May-86	20	2977	0.1292	0.66	1162	1598	672
6-46-52	Lower Stanislaus (MRFF)	N/A	58	12,768	89	5-May-86	18-May-86	6	2777	0.1377	0.44	560	644	306
	Total	29-Apr-86		106,169		3-May-86	25-May-86	60	4377	0.1322	0.56			

1985

Fall Run Releases

Upper Sacramento River and Tributaries

H5-3-7	Battle Creek (CNFH)	N/A	N/A	29,136	47	-	-	0	-	-	-	0	0	13
H5-4-1	Battle Creek (CNFH)	N/A	N/A	23,045	47	-	-	0	-	-	-	0	0	10
	Total	31-Mar-85		52,181										
H6-5-5	Below RBDD (CNFH)	14-Feb-85	N/A	N/A	49,155	47	-	-	0	-	-	0	2*	74
H6-6-5	Below RBDD (CNFH)	14-Mar-85	N/A	N/A	52,313	48	-	-	0	-	-	0	0	198

5-39-4	Battle Creek (CNFH)		N/A	N/A	11,484	80	21-May-85	23-May-85	2	600	0.1389	0.16	0	0	0
5-40-4	Battle Creek (CNFH)		N/A	N/A	10,698	82	22-May-85	25-May-85	2	800	0.1389	0.17	0	0	21
5-41-4	Battle Creek (CNFH)		N/A	N/A	10,330	80	21-May-85	23-May-85	3	600	0.1389	0.27	0	0	8
H5-1-5	Battle Creek (CNFH)		N/A	N/A	22,558	80	20-May-85	22-May-85	3	600	0.1389	0.12	0	0	32
5-6-16	Battle Creek (CNFH)		N/A	N/A	10,209	80	24-May-85	24-May-85	1	200	0.1389	0.09	0	0	0
	Total	14-May-85			65,279		20-May-85	25-May-85	11	1200	0.1389		0.16		
5-9-47	Below RBDD (CNFH)		N/A	N/A	21,871	82	21-May-85	24-May-85	2	800	0.1389	0.09	0	0	30
5-42-4	Below RBDD (CNFH)		N/A	N/A	10,610	82	21-May-85	31-May-85	5	2200	0.1389	0.44	0	0	47
5-43-4	Below RBDD (CNFH)		N/A	N/A	9,756	82	22-May-85	23-May-85	3	400	0.1389	0.29	0	0	28
H5-1-6	Below RBDD (CNFH)		N/A	N/A	23,378	82	22-May-85	24-May-85	9	600	0.1389	0.36	0	0	27
	Total	14-May-85			65,615		21-May-85	31-May-85	19	2200	0.1389		0.27		
5-9-48	Princeton (CNFH)		N/A	N/A	21,943	82	21-May-85	24-May-85	3	800	0.1389	0.13	0	0	69
5-9-49	Princeton (CNFH)		N/A	N/A	20,460	82	21-May-85	22-May-85	3	400	0.1389	0.14	0	0	68
H5-1-7	Princeton (CNFH)		N/A	N/A	23,519	82	20-May-85	22-May-85	3	600	0.1389	0.12	0	0	34
	Total	15-May-85			65,922		20-May-85	24-May-85	9	1000	0.1389		0.13		
Sacramento-San Joaquin Estuary															
H6-5-6	Courtland (CNFH)	19-Feb-85	N/A	N/A	51,201	48	-	-	0	-	-	-	0	0	103
H6-6-4	Courtland (CNFH)	7-Mar-85	N/A	N/A	51,985	46	-	-	0	-	-	-	0	(3) 6*	89
H6-6-1	South Fork Mok. (CNFH)	26-Feb-85	N/A	N/A	50,052	48	-	-	0	-	-	-	2*	(2) 1*	69
H6-6-2	North Fork Mok. (CNFH)	28-Feb-85	N/A	N/A	51,145	46	-	-	0	-	-	-	0	(1) 3*	78
H6-5-7	Ryde (CNFH)	21-Feb-85	N/A	N/A	49,183	47	-	-	0	-	-	-	0	0	83
H6-6-3	Ryde (CNFH)	5-Mar-85	N/A	N/A	50,550	47	-	-	0	-	-	-	1*	(2) 8*	98
6-62-42	Lower Old	8-May-85	54	68	105,289	84	11-May-85	25-May-85	20	3000	0.1389	0.18	5136	9638	232

	River (FRH)															
6-62-34	South Fork Mok. (FRH)	7-May-85	48	64	100,386	75	14-May-85	27-May-85	25	2800	0.1389	0.23	80	9	317	
6-62-36	North Fork Mok. (FRH)	9-May-85	54	65	101,236	77	14-May-85	27-May-85	30	2800	0.1389	0.28	10	4	656	
6-62-38	Courtland (FRH)		60	64	54,457	78	14-May-85	25-May-85	23	2400	0.1389	0.40	0	0	230	
6-62-39	Courtland (FRH)		60	64	14,731	78	14-May-85	25-May-85	2	2400	0.1389	0.13	0	0	24	
6-62-40	Courtland (FRH)		60	64	10,887	78	14-May-85	25-May-85	3	2400	0.1389	0.26	0	0	49	
6-62-41	Courtland (FRH)		60	64	20,551	78	14-May-85	25-May-85	9	2400	0.1389	0.41	0	0	83	
	Total	10-May-85			100,626		14-May-85	25-May-85	37	2400	0.1389	0.34				
6-62-35	Ryde (FRH)	11-May-85	51	66	107,161	78	14-May-85	25-May-85	88	2400	0.1389	0.77	0	0	926	
6-62-45	Port Chicago (FRH)	13-May-85	58	66	48,143	76	14-May-85	27-May-85	8	-	-		0	0	465	
6-62-44	Fort Baker (FRH)	14-May-85	N/A	N/A	47,518	N/A	-	-	0	-	-		0	0	537	

1984

Fall Run Releases

Upper Sacramento River and Tributaries

H6-4-4	Below RBDD (CNFH)	1-Mar-84	N/A	N/A	43,883	45	-	-	0	-	-		1*	0	124
H6-5-4	Below RBDD (CNFH)	24-Mar-84	N/A	N/A	47,855	50	-	-	0	-	-		0	0	234
6-60-42	Battle Creek (CNFH)		N/A	N/A	50,742	90	16-May-84	23-May-84	19	730	0.0634	0.77	0	0	920
6-60-43	Battle Creek (CNFH)		N/A	N/A	49,479	90	16-May-84	23-May-84	16	730	0.0634	0.66	0	0	855
	Total	9-May-84			100,221		16-May-84	23-May-84	35	730	0.0634	0.72			
6-60-40	Below RBDD (CNFH)		N/A	N/A	51,948	90	15-May-84	23-May-84	29	890	0.0687	1.06	0	0	1055
6-60-41	Below RBDD (CNFH)		N/A	N/A	50,921	90	15-May-84	23-May-84	29	890	0.0687	1.08	0	0	1151

	Total	9-May-84			102,869		15-May-84	23-May-84	58	890	0.0687		1.07		
6-60-38	Knights Landing (CNFH)		N/A	N/A	49,400	90	13-May-84	23-May-84	19	930	0.0587	0.85	0	0	953
6-60-39	Knights Landing (CNFH)		N/A	N/A	49,351	90	15-May-84	23-May-84	17	890	0.0687	0.65	0	0	1002
	Total	9-May-84			98,751		13-May-84	23-May-84	36	930	0.0587		0.81		
Sacramento-San Joaquin Estuary															
H6-4-5	Courtland (CNFH)	5-Mar-84	N/A	N/A	48,460	45	-	-	0	-	-		0	0	67
H6-5-3	Courtland (CNFH)	21-Mar-84	N/A	N/A	48,157	48	-	-	0	-	-		0	0	179
H6-4-6	Ryde (CNFH)	8-Mar-84	N/A	N/A	45,465	49	-	-	0	-	-		4*	0	82
H6-5-2	Ryde (CNFH)	19-Mar-84	N/A	N/A	46,767	49	-	-	0	-	-		4*	0	142
H6-5-1	South Fork Mok. (CNFH)	14-Mar-84	N/A	N/A	45,036	49	-	-	0	-	-		3*	0	39
H6-4-7	North Fork Mok. (CNFH)	12-Mar-84	N/A	N/A	42,165	50	-	-	0	-	-		5*	0	61
6-62-27	Courtland (FRH)	11-Jun-84	54	66	62,604	82	14-Jun-84	28-Jun-84	37	2360	0.1093	0.70	0	0	399
6-62-28	South Fork Mok. (FRH)		54	67	41,371	77	16-Jun-84	26-Jun-84	25	1720	0.1086	0.72	0	0	289
6-42-8	South Fork Mok. (FRH)		54	67	14,916	77	17-Jun-84	22-Jun-84	9	1020	0.1181	0.66	0	0	62
	Total	12-Jun-84			56,287		16-Jun-84	26-Jun-84	34	1720	0.1086		0.72		
6-62-29	Ryde (FRH)		56	66	44,818	77	16-Jun-84	26-Jun-84	30	2100	0.1326	0.66	0	0	195
6-42-9	Ryde (FRH)		56	66	15,180	77	17-Jun-84	28-Jun-84	8	1900	0.1100	0.62	0	0	73
	Total	13-Jun-84			59,998		16-Jun-84	28-Jun-84	38	2100	0.1122		0.73		
6-62-32	North Fork Mok. (FRH)	14-Jun-84	55	67	59,808	79	18-Jun-84	3-Jul-84	24	2149	0.0933	0.56	0	0	266
6-62-33	Lower Old	15-Jun-84	58	75	64,896	73	20-Jun-84	27-Jun-84	9	1300	0.1128	0.16	48	0	40

River (FRH)																
6-48-22	Thornton (FRH)		N/A	N/A	47,500	77	27-Jun-84	29-Jun-84	6	580	0.1343	0.12		0	0	45
6-48-23	Thornton (FRH)		N/A	N/A	47,500	77	26-Jun-84	30-Jun-84	10	940	0.1306	0.21		0	0	34
	Total	22-Jun-84			95,000		26-Jun-84	30-Jun-84	16	940	0.1306		0.17			
6-62-31	Port Chicago (FRH)		59	72	18,442	80	30-Jun-84	30-Jun-84	9	-	-			0	0	93
6-62-37	Port Chicago (FRH)		59	72	23,558	86	30-Jun-84	3-Jul-84	21	-	-			0	0	223
	Total	29-Jun-84			42,000		30-Jun-84	3-Jul-84	30							
6-54-51	Port Chicago (NFH)	23-Jul-84	N/A	N/A	50,114	N/A	-	-	0	-	-			0	0	1159
6-54-52	Fort Baker (NFH)	25-Jul-84	N/A	N/A	48,677	N/A	-	-	0	-	-			0	0	1461

1983

Fall Run Releases

Upper Sacramento River and Tributaries

6-60-36	Battle Creek (CNFH)		N/A	N/A	44,382	77	7-Jun-83	24-Jun-83	15	1753	0.0676	0.65		0	0	96
6-60-37	Battle Creek (CNFH)		N/A	N/A	43,508	76	7-Jun-83	17-Jun-83	10	1373	0.0867	0.34		0	0	97
	Total	2-Jun-83			87,890		7-Jun-83	24-Jun-83	25	1753	0.0676		0.55			
6-60-34	Below RBDD (CNFH)		N/A	N/A	44,498	76	7-Jun-83	15-Jun-83	16	1193	0.0921	0.51		0	0	22
6-60-35	Below RBDD (CNFH)		N/A	N/A	45,343	75	7-Jun-83	21-Jun-83	10	1553	0.0719	0.40		0	0	72
	Total	2-Jun-83			89,841		7-Jun-83	21-Jun-83	26	1553	0.0719		0.52			
6-60-32	Knights Landing (CNFH)		N/A	N/A	45,986	75	5-Jun-83	15-Jun-83	45	1593	0.1006	1.26		0	0	72
6-60-33	Knights Landing (CNFH)		N/A	N/A	46,099	74	5-Jun-83	21-Jun-83	31	1953	0.0798	1.10		0	0	56
	Total	2-Jun-83			92,085		5-Jun-83	21-Jun-83	76	1953	0.0798		1.34			

Sacramento-San Joaquin Estuary

H6-3-3	Isleton (FRH)	4-Mar-83	N/A	N/A	45,775	44	-	-	0	-	-	0	0	9	
H6-4-2	Isleton (FRH)	29-Mar-83	N/A	N/A	47,518	49	8-Apr-83	29-May-83	3	-	-	0	0	36	
H6-3-4	Courtland (FRH)	9-Mar-83	N/A	N/A	48,541	47	19-May-83	19-May-83	1	-	-	0	0	14	
H6-4-3	Courtland (FRH)	31-Mar-83	N/A	N/A	48,501	51	12-Apr-83	24-May-83	6	-	-	0	0	62	
H6-3-5	Lower Mokelumne (FRH)	14-Mar-83	N/A	N/A	45,960	N/A	26-Apr-83	26-Apr-83	1	200	0.1389	0.02	0	0	11
H6-4-1	Lower Mokelumne (FRH)	24-Mar-83	N/A	N/A	47,367	48	15-Apr-83	19-Apr-83	2	380	0.0528	0.10	0	0	41
H6-3-6	Lower Old River (FRH)	17-Mar-83	N/A	N/A	47,677	49	-	-	0	-	-	0	0	61	
H6-3-7	Lower Old River (FRH)	22-Mar-83	N/A	N/A	48,580	48	19-May-83	19-May-83	1	-	-	0	0	60	
6-62-24	Courtland (FRH)	16-May-83	52	60	96,706	79	19-May-83	10-Jun-83	92	3370	0.1018	1.22	0	0	428
6-62-26	Lower Old River (FRH)	17-May-83	53	63	89,500	76	22-May-83	10-Jun-83	23	2770	0.0962	0.35	0	0	99
6-62-25	Lower Mokelumne (FRH)	19-May-83	56	63	83,435	75	24-May-83	15-Jun-83	72	3183	0.0961	1.17	0	0	270
6-62-23	Isleton (FRH)	20-May-83	57	61	92,693	81	22-May-83	7-Jun-83	95	2350	0.0960	1.39	0	0	368
6-62-30	Port Chicago (FRH)	23-May-83	50	67	43,374	75	-	-	0	-	-	0	0	129	

1982

Fall Run Releases

Upper Sacramento River and Tributaries

H6-2-2	Below RBDD	5-Feb-82	N/A	N/A	41,753	44	13-Apr-82	23-Apr-82	4	-	-	0	0	114
--------	------------	----------	-----	-----	--------	----	-----------	-----------	---	---	---	---	---	-----

	(CNFH)														
H6-2-6	Below RBDD (CNFH)	25-Feb-82	N/A	N/A	43,673	44	3-May-82	21-May-82	5	-	-		0	0	116
6-60-26	Battle Creek (CNFH)		N/A	N/A	42,964	80	13-May-82	7-Jun-82	37	2540	0.0678	1.65	0	0	285
6-60-27	Battle Creek (CNFH)		N/A	N/A	41,738	80	13-May-82	24-May-82	27	1920	0.1111	0.76	0	0	467
	Total	5-May-82			84,702		13-May-82	7-Jun-82	64	2540	0.0678	1.45			
6-60-28	Below RBDD (CNFH)		N/A	N/A	44,308	82	13-May-82	15-Jun-82	34	3940	0.0805	1.24	0	0	339
6-60-29	Below RBDD (CNFH)		N/A	N/A	43,817	82	10-May-82	24-May-82	35	2120	0.0981	1.06	0	0	390
	Total	5-May-82			88,125		10-May-82	15-Jun-82	69	4340	0.0815	1.25			
6-60-30	Knights Landing (CNFH)		N/A	N/A	44,735	81	10-May-82	24-May-82	50	2120	0.0981	1.48	0	0	398
6-60-31	Knights Landing (CNFH)		N/A	N/A	44,540	81	10-May-82	24-May-82	41	2120	0.0981	1.22	0	0	304
	Total	5-May-82			89,275		10-May-82	24-May-82	91	2120	0.0981	1.35			
Sacramento-San Joaquin Estuary															
H6-2-3	Isleton (CNFH)	11-Feb-82	N/A	N/A	43,248	44	-	-	0	-	-		0	0	32
H6-2-7	Isleton (CNFH)	2-Mar-82	N/A	N/A	40,508	45	17-May-82	17-May-82	1	-	-		0	0	11
H6-2-4	Mouth of Mok. R. (CNFH)	17-Feb-82	N/A	N/A	43,849	43	-	-	0	-	-		0	0	24
H6-3-2	Mouth of Mok. R. (CNFH)	10-Mar-82	N/A	N/A	41,470	44	-	-	0	-	-		0	0	22
	Total				85,319										
H6-2-5	Berkeley (CNFH)	22-Feb-82	N/A	N/A	40,699	44	-	-	0	-	-		0	0	5
H6-3-1	Berkeley (CNFH)	8-Mar-82	N/A	N/A	39,321	44	-	-	0	-	-		0	0	0

6-46-28	Dos Reis (MRFF)	24-Apr-82	N/A	N/A	48,227	67	10-May-82	20-May-82	23	1720	0.1086	0.57	0	0	552
6-62-20	Discovery Park (FRH)	11-May-82	N/A	60	85,885	78	14-May-82	17-Jun-82	100	4080	0.0810	1.87	0	0	1282
6-62-18	Discovery Park (CNFH)	12-May-82	N/A	60	89,780	78	15-May-82	9-Jun-82	136	2580	0.0689	2.86	0	0	1085
6-62-19	Port Chicago (CNFH)	17-May-82	N/A	N/A	86,877	76	-	-	0	-	-	-	-	-	782
6-62-21	Discovery Park (FRH)	4-Jun-82	56	68	60,822	76	9-Jun-82	17-Jun-82	30	1520	0.1173	0.55	0	0	392
6-62-22	Port Chicago (FRH)	8-Jun-82	N/A	N/A	63,221	72	8-Jun-82	17-Jun-82	41	-	-	-	-	-	365

Upper San Joaquin River and Tributaries

6-46-17	Merced River Fish Facility	22-Apr-82	N/A	N/A	49,217	68	13-May-82	16-Jun-82	19	4060	0.0806	0.62	24	0	428
---------	----------------------------	-----------	-----	-----	--------	----	-----------	-----------	----	------	--------	------	----	---	-----

1981

Fall Run Releases

Upper Sacramento River and Tributaries

H6-1-1	Below RBDD (CNFH)	6-Feb-81	N/A	N/A	35,905	41	-	-	0	-	-	-	0	0	42
H6-1-5	Below RBDD (CNFH)	28-Feb-81	N/A	N/A	47,019	40	11-May-81	11-May-81	2	-	-	-	0	0	65
5-5-58	Coyote Creek (TCFF)	8-May-81	N/A	N/A	11,031	89	14-May-81	14-May-81	1	200	0.1389	0.08	0	0	155
5-5-57	Coyote Creek (TCFF)	13-May-81	N/A	N/A	10,823	89	21-May-81	21-May-81	3	200	0.1389	0.26	0	0	177
6-60-16	Battle Creek (CNFH)	18-May-81	N/A	N/A	86,213	79	26-May-81	28-May-81	5	360	0.0833	0.09	0	0	281
6-60-17	Below RBDD (CNFH)	18-May-81	N/A	N/A	84,967	79	26-May-81	28-May-81	8	360	0.0833	0.15	0	0	394
6-60-20	Knights Landing		N/A	N/A	43,059	77	28-May-81	28-May-81	3	160	0.1111	0.08	0	0	175

6-60-21	(CNFH) Knights Landing (CNFH) Total		N/A	N/A	43,562	77	28-May-81	4-Jun-81	2	480	0.0417	0.14		0	0	246
		18-May-81			86,621		28-May-81	4-Jun-81	5	480	0.0417		0.18			
6-62-13	Feather River Hatchery				97,438	90	-	-	0	-	-			0	0	8
6-62-16	Feather River Hatchery Total	1-Jun-81	55	55	178,831									0	0	12

**Sacramento-San
Joaquin Estuary**

H6-1-4	Berkeley (CNFH)	25-Feb-81	N/A	N/A	49,705	44	-	-	0	-	-			0	0	6
H6-2-1	Berkeley (CNFH)	8-Mar-81	N/A	N/A	36,901	43	-	-	0	-	-			0	0	0
H6-1-3	Mouth of Mok. R. (CNFH)	20-Feb-81	N/A	N/A	45,193	44	-	-	0	-	-			2*	0	10
H6-1-7	Mouth of Mok. R. (CNFH)	6-Mar-81	N/A	N/A	45,796	43	-	-	0	-	-			2*	0	36
H6-1-2	Isleton (CNFH)	12-Feb-81	N/A	N/A	40,916	45	-	-	0	-	-			3*	0	16
H6-1-6	Isleton (CNFH) Total	4-Mar-81	N/A	N/A	45,949	43	-	-	0	-	-			0	0	72
					86,865											
6-58-23	Rio Vista (FRH)	2-Jun-81	N/A	72	8,864	83	4-Jun-81	8-Jun-81	9	860	0.1194	1.11		0	0	219
6-62-14	Discovery Park (FRH)				71,932	91	10-Jun-81	10-Jun-81	1	160	0.1111	0.02		0	0	24
6-62-17	Discovery Park (FRH) Total	4-Jun-81	57	76	68,318	88	-	-	0	-	-	0.00		0	0	22
					140,249	90	10-Jun-81	10-Jun-81	1	160	0.1111		0.01			
6-62-15	Port Chicago (FRH)	8-Jun-81	55	75	78,339	90	9-Jun-81	9-Jun-81	2	160	0.1111	0.03		0	0	2198

1980

Fall Run Releases

Upper Sacramento River and Tributaries

H5-3-1	Below RBDD (CNFH)	N/A	N/A	25,618	47	-	-	0	-	-	0	0	134		
H5-3-2	Below RBDD (CNFH)	N/A	N/A	22,560	47	-	-	0	-	-	0	0	121		
	Total	28-Feb-80		48,178											
H5-3-5	Below RBDD (CNFH)	N/A	N/A	21,786	45	15-May-80	15-May-80	1	-	-	0	0	189		
H5-3-6	Below RBDD (CNFH)	N/A	N/A	21,836	45	-	-	0	-	-	0	0	130		
	Total	31-Mar-80		43,622											
6-62-7	Feather River Hatchery	3-Jun-80	55	55	88,335	94	10-Jun-80	23-Jun-80	15	2733	0.1356	0.16	0	0	292
6-62-10	Feather River Hatchery	5-Jun-80	55	55	88,516	93	12-Jun-80	22-Jun-80	15	2176	0.1374	0.16	0	0	497

Sacramento-San Joaquin Estuary

H5-2-4	Berkeley (CNFH)	N/A	N/A	21,939	46	-	-	0	-	-	0	0	3		
H5-2-5	Berkeley (CNFH)	N/A	N/A	20,788	46	-	-	0	-	-	0	0	0		
	Total	28-Feb-80		42,727											
H5-2-6	Clarksburg (CNFH)	N/A	N/A	22,121	50	-	-	0	-	-	0	0	29		
H5-2-7	Clarksburg (CNFH)	N/A	N/A	21,624	50	-	-	0	-	-	0	0	59		
	Total	28-Feb-80		43,745											
H5-3-3	Clarksburg (CNFH)	N/A	N/A	23,908	46	17-Apr-80	1-May-80	2	-	-	0	0	28		
H5-3-4	Clarksburg (CNFH)	N/A	N/A	22,829	44	24-Apr-80	1-May-80	2	-	-	0	0	42		
	Total	31-Mar-80		46,737											
6-62-8	Discovery Park (FRH)	3-Jun-80	52	62	98,586	96	6-Jun-80	27-Jun-80	33	4315	0.1362	0.32	0	0	951

6-62-11	Discovery Park (FRH)	5-Jun-80	52	62	84,643	96	8-Jun-80	23-Jun-80	34	3135	0.1361	0.38	0	0	678
6-62-9	Port Chicago (FRH)	10-Jun-80	55	65	88,700	92	16-Jun-80	16-Jun-80	2	-	-				1882
6-62-12	Port Chicago (FRH)	13-Jun-80	55	63	79,443	92	12-Jun-80	15-Jun-80	4	-	-				1786

1979

Fall Run Releases

Upper Sacramento River and Tributaries

6-62-4	Feather River Hatchery	4-Jun-79	N/A	N/A	181,028	79	-	-	0	-	-		0	0	9
--------	------------------------	----------	-----	-----	---------	----	---	---	---	---	---	--	---	---	---

Sacramento-San Joaquin Estuary

6-62-5	Discovery Park (FRH)	6-Jun-79	54	68	160,151	75	10-Jun-79	25-Jun-79	50	2193	0.0952	0.43	0	0	99
6-62-6	Port Chicago (FRH)	6-Jun-79	67	69.5	110,122	87	15-Jun-79	15-Jun-79	1	-	-				837

1978

Fall Run releases

Upper Sacramento River and Tributaries

6-62-1	Feather River Hatchery	5-Jun-78	N/A	N/A	178,998	88	-	-	0	-	-		0	0	0
--------	------------------------	----------	-----	-----	---------	----	---	---	---	---	---	--	---	---	---

Sacramento-San Joaquin Estuary

6-62-2	Discovery Park (FRH)	5-Jun-78	57	73	162,253	91	-	-	0	-	-		0	0	54
6-62-3	Port Chicago (FRH)	5-Jun-78	57	68	164,766	89	9-Jun-78	9-Jun-78	1	200	0.1389	0.01	0	0	5360

Notes:

(1) 8 fish subtracted to correct for 10,500 inadvertently released with the Georgiana Slough group on 4/14/92. 0.078% of the 6-1-14-3-2 code group released at Georgiana Slough was recovered at Chipps Island.

Thus, we assume survival of the 10,500 6-1-14-3-1 fish released at Georgiana Slough to be 0.078%

(8 fish).

39 fish were also subtracted from the expanded ocean recoveries (representing .078%).

(2) These groups were at large during the period of non-sampling, May 24, 26, 27 and 28, thus estimates of survival are biased low by an unknown amount.

(3) The original data has been changed to reflect only tagged fish caught before the non-sampling period.

(4) 5 fish subtracted from Miller Park recoveries due to 6,315 fish inadvertently being released with the Port Chicago group (tag # 6-31-9).

(5) 6,315 fish subtracted from total number released due to 12.2% having tag # 6-31-10 (Miller Park).

(6) 1 fish was recovered at Chipps Island on June 26th, but was not included so that the survival index would not be biased.

(7) Total number recovered for both tag # 6-62-61 and 6-62-62 is reduced by 1 since one fish for each code.

was recorded as being recovered at Chipps Island on the day of release (6/23).

(8) 1,230 fish were removed from this group during Mossdale efficiency studies.

* = Unexpanded recovery

Salvage numbers in parenthesis are unexpanded and have an unknown location (either CVP or SWP)

In some cases average size was calculated from # fish / lb. using a conversion table (Table I-6, Fish Hatchery Management, USFWS, 1982)